

› GND Series

Classic Solid State Relays

Panel Mount - DC Output

- › Output current of 10 and 40 Amps
- › Output Voltage of 5-60 V_{DC} and 5-200 V_{DC}
- › Control voltage of 4-32 V_{DC}
- › DC switching (DC loads)
- › Integrated IP20 touch-safe removable covers
- › Built-in overvoltage protection
- › LED input status indicator



DC Switching
Version

Product Selection - DC switching (DC loads)		
Rated Load Current	10A	40A
Output Voltage	5-200 V _{DC}	5-60 V _{DC}
Control Voltage		
4-32 V _{DC}	84137850N	84137870N

PART NUMBERING SYSTEM

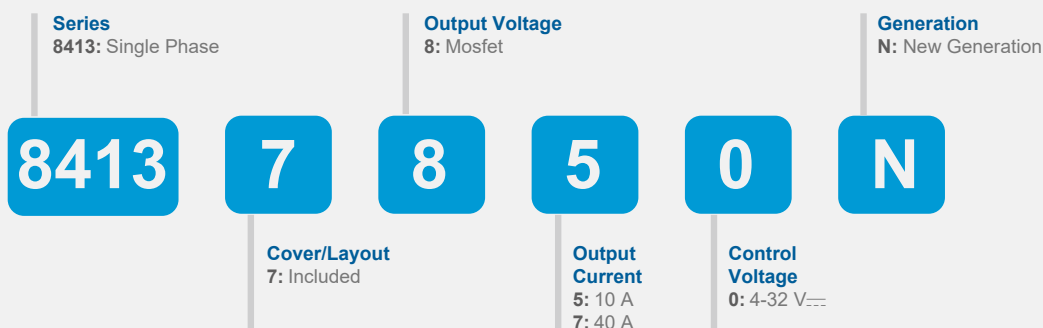

Do you need an adapted or customized solution? Contact us on www.crouzet.com

Description:

Crouzet Solid State Relays are designed to be used in almost any application, offering very long life expectancy and are easy to install, easy to use, robust and multipurpose.

For more information about Crouzet's Solid State relays, please visit www.crouzet.com.

Accessories		
Type	Description	Part-Number
Heatsink	0.9 °C/W Thermal Resistance	26532752N
Heatsink	1.1 °C/W Thermal Resistance	26532753N
Heatsink	1.2 °C/W Thermal Resistance	26532754N
Heatsink	1.75 °C/W Thermal Resistance	26532755N
Heatsink	2.2 °C/W Thermal Resistance	26532756N
Adapter	DIN Rail	26532764N
Thermal Pad	Self-Adhesive Thermal Pad	26532722N
Screws	Screw Mounting Kit	26532001
Thermal Grease	Thermal Grease for Heatsink mounting	26532003

Output Specifications ⁽¹⁾		
Description	10A	40A
Maximum Load Current [Arms] ⁽³⁾	20	40
Minimum Load Current [mArms]	5	
Typical Operating Voltage [Vrms]	5-110 V ₋₋₋	5-60 V ₋₋₋
Min / Max Operating Voltage [Vrms]	5-200 V ₋₋₋	5-60 V ₋₋₋
Transient Voltage [Vpk]	200	100
Maximum Off-State Leakage Current @ Rated Voltage [mArms]	3	
Minimum Off-State dV/dt @ Maximum Rated Voltage [V/μsec]	N/A	
Non-repetitive peak overload current @ 100 ms [Apeak]	380 @t=0.1 ms	320 @t=0.1 ms
Maximum On-State Voltage Drop @ Rated Current [Vpeak]	0.97	1.05
Thermal Resistance Junction to Case (Rjc) [°C/W]	0.66	0.9
Minimum Heat Sink for Rated Current @ 40 °C [°C/W]	3.4	1.15

Input Specifications	
Description	4-32 V ₋₋₋
Input Voltage Range	4-32 V ₋₋₋ ⁽⁴⁾
Maximum Reverse Voltage	-32 V ₋₋₋
Minimum Turn-On Voltage	3.5 V ₋₋₋
Must Turn-Off Voltage	1 V ₋₋₋
Minimum Input Current (for on-state)	34 mA
Maximum Input Current [mA]	35 mA
Nominal Input Impedance [Ohms]	Current Limited
Maximum Turn-On Time [msec]	0.02
Maximum Turn-Off Time [msec]	0.02

General Specifications		
Description	10A	40A
Dielectric Strength, Input/Output to Ground (50/60 Hz)	2500 V	
Minimum Insulation Resistance (@ 500 V ₋₋₋)	10 ⁹ Ω	
Maximum Capacitance, Input/Output	8pf	
Ambient Operating Temperature Range	-25 to 90 °C	
Ambient Storage Temperature Range	-40 to 100 °C	

General Specifications		
Description	10A	40A
Weight (typical)	80 g	
Housing Material	UL94 V-0	
Baseplate Material	Aluminium	
Input Terminal Screw Torque Range (in-lb/Nm)	11-18 / 1.2-2.0	
Load Terminal Screw Torque Range (in-lb/Nm)	18-26 / 2-3	
SSR Mounting Screw Torque Range (in-lb/Nm)	11-16 / 1.2-1.8	
Humidity per IEC60068-2-78	40-85 %	
LED Input Status Indicator	Green	
MTBF (Mean Time Between Failures) at 40 °C ambient temperature ⁽⁵⁾	25	
MTBF (Mean Time Between Failures) at 60 °C ambient temperature ⁽⁵⁾	17	

General Notes
⁽¹⁾ All parameters at 25 °C unless otherwise specified
⁽³⁾ Heat sinking required, see derating curves
⁽⁴⁾ Increase minimum voltage by 1 V for operations from -20 to -40 °C
⁽⁵⁾ All parameters at 50 % power rating and 100 % duty cycle (contact tech support for detailed report)

Diagrams

Wiring

GND

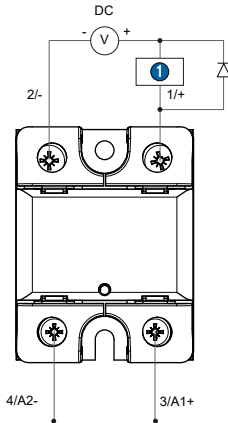

TERMINALS	WIRE SIZE		Terminal Screw Torque (N.m)
	SOLID	STRANDED	
Input	18..14 AWG (0.75..2.5 mm ²) 2 x 18..14 AWG (0.75..2.5 mm ²)	18..14 AWG (0.75..2.5 mm ²) 2 x 18..14 AWG (0.75..2.5 mm ²)	1.2 - 2
Output	16..8 AWG (1.5..10 mm ²) 2 x 16..8 AWG (1.5..10 mm ²)	16..8 AWG (1.5..6 mm ²) 2 x 16..10 AWG (1.5..6 mm ²)	2 - 3

GND

① Load

Diagrams

Equivalent Circuit Block

GND Series DC control without output protection

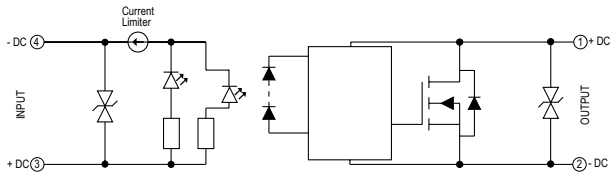

Input current vs Input Voltage
Standard Regulated DC inputs

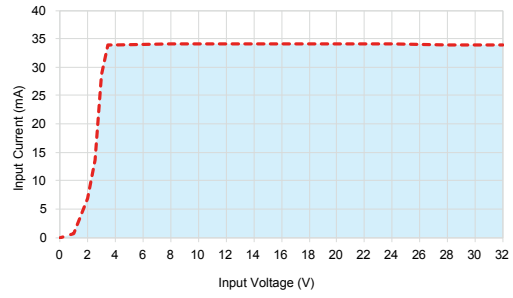

Diagrams

Dimensions (mm)

GND front view

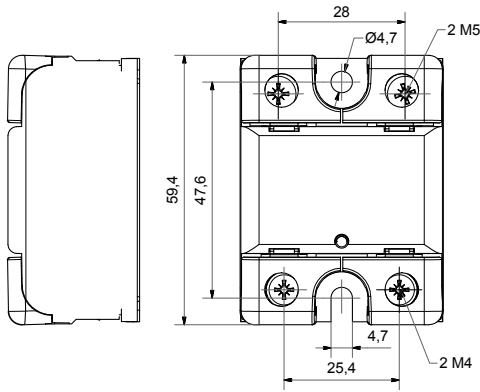

GND side view

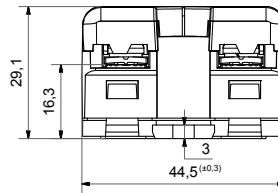

Curves

Surge Current Information

GND - 10 A

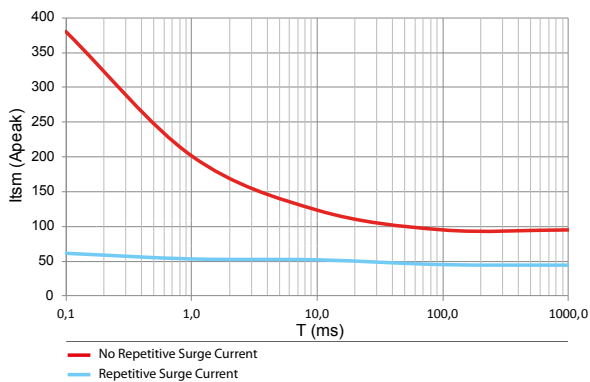

GND - 40 A

