

NINA-B3 series

Stand-alone Bluetooth 5 low energy modules

Data sheet

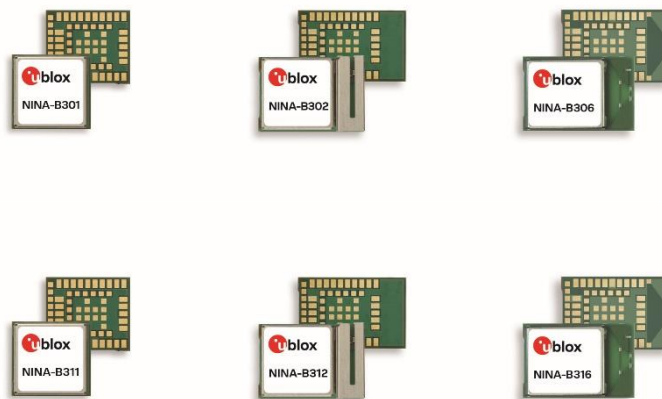

Abstract

This technical data sheet describes the stand-alone NINA-B3 series Bluetooth® 5 low energy modules. The NINA-B3 series includes two sub-series – the NINA-B30 and NINA-B31 series. The NINA-B30 series provides an open CPU architecture with a powerful MCU for customer applications, while the NINA-B31 series are delivered with u-connectXpress software pre-flashed.

Document information

Title	NINA-B3 series	
Subtitle	Stand-alone Bluetooth 5 low energy modules	
Document type	Data sheet	
Document number	UBX-17052099	
Revision and date	R12	29-May-2023
Disclosure restriction	C1-Public	

Product status	Corresponding content status	
Functional Sample	Draft	For functional testing. Revised and supplementary data will be published later.
In Development / Prototype	Objective Specification	Target values. Revised and supplementary data will be published later.
Engineering Sample	Advance Information	Data based on early testing. Revised and supplementary data will be published later.
Initial Production	Early Production Information	Data from product verification. Revised and supplementary data may be published later.
Mass Production / End of Life	Production Information	Document contains the final product specification.

This document applies to the following products:

Product name	Type number	Open CPU	Hardware version	PCN reference	Product status
NINA-B301	NINA-B301-00B-00		05	UBX-23001751	Initial Production
NINA-B302	NINA-B302-00B-00		04	UBX-23001751	Initial Production
NINA-B306	NINA-B306-00B-00		05	UBX-23001751	Initial Production
NINA-B306	NINA-B306-01B-00		05	UBX-23001751	Initial Production

Product name	Type number	u- connectXpress software version	Hardware version	PCN reference	Product status
NINA-B311	NINA-B311-00B-00	1.0.0	05	UBX-23001751	Initial Production
NINA-B311	NINA-B311-01B-00	2.0.0	05	UBX-23001751	Initial Production
NINA-B311	NINA-B311-02B-00	4.0.0	05	UBX-23001751	Initial Production
NINA-B312	NINA-B312-00B-00	1.0.0	05	UBX-23001751	Initial Production
NINA-B312	NINA-B312-01B-00	2.0.0	05	UBX-23001751	Initial Production
NINA-B312	NINA-B312-02B-00	4.0.0	05	UBX-23001751	Initial Production
NINA-B316	NINA-B316-01B-00	2.0.0	05	UBX-23001751	Initial Production
NINA-B316	NINA-B316-02B-00	4.0.0	05	UBX-23001751	Initial Production

u-blox or third parties may hold intellectual property rights in the products, names, logos and designs included in this document. Copying, reproduction, or modification of this document or any part thereof is only permitted with the express written permission of u-blox. Disclosure to third parties is permitted for clearly public documents only.

The information contained herein is provided "as is". No warranty of any kind, either express or implied, is made in relation to the accuracy, reliability, fitness for a particular purpose or content of this document. This document may be revised by u-blox at any time. For most recent documents, please visit www.u-blox.com.

Copyright © u-blox AG.

Contents

Document information	2
Contents	3
1 Functional description.....	6
1.1 Overview.....	6
1.2 Applications	6
1.3 Product features	7
1.3.1 NINA-B30 series.....	7
1.3.2 NINA-B31 series.....	8
1.4 Block diagram	9
1.4.1 NINA-B3x1.....	9
1.4.2 NINA-B3x2.....	9
1.4.3 NINA-B3x6.....	9
1.5 Product description	10
1.6 Hardware options.....	10
1.7 Software options.....	10
1.7.1 u-connectXpress software	11
1.7.2 Open CPU.....	11
1.8 Bluetooth device address	11
2 Interfaces	12
2.1 Power management	12
2.1.1 Module supply input (VCC)	12
2.1.2 Digital I/O interfaces reference voltage (VCC_IO).....	12
2.2 RF antenna interfaces	12
2.2.1 2.4 GHz radio (ANT).....	12
2.2.2 Near Field Communication (NFC).....	13
2.3 System functions.....	13
2.3.1 Module power-on	13
2.3.2 Module power off	13
2.3.3 Standby mode	14
2.3.4 Sleep mode.....	14
2.3.5 Module reset	14
2.3.6 CPU and memory	14
2.3.7 Direct Memory Access.....	15
2.3.8 Programmable Peripheral Interconnect.....	15
2.3.9 Real Time Counter (RTC).....	15
2.4 Serial interfaces	15
2.4.1 Universal Asynchronous Receiver/Transmitter (UART).....	15
2.4.2 Serial peripheral interface (SPI)	16
2.4.3 Quad serial peripheral interface (QSPI).....	16
2.4.4 Inter-Integrated Circuit interface (I2C)	17

2.4.5	Inter-IC Sound interface (I2S)	17
2.4.6	USB 2.0 interface.....	17
2.5	Digital interfaces.....	18
2.5.1	Pulse Width Modulation (PWM)	18
2.5.2	Pulse Density Modulation (PDM).....	18
2.5.3	Quadrature Decoder (QDEC)	18
2.6	Analog interfaces	18
2.6.1	Analog to Digital Converter (ADC).....	18
2.6.2	Comparator	19
2.6.3	Low power comparator	19
2.6.4	Analog pin options.....	19
2.7	GPIO	20
2.7.1	Drive strength.....	20
2.8	u-connectXpress software features	20
2.8.1	u-blox Serial Port Service (SPS)	20
2.8.2	System status signals.....	20
2.8.3	System control signals	21
2.8.4	UART	21
2.9	Debug interfaces.....	22
2.9.1	SWD.....	22
2.9.2	Trace – Serial Wire Output.....	22
2.9.3	Parallel Trace	22
3	Pin definition.....	23
3.1	NINA-B30 series pin assignment.....	23
3.2	NINA-B31 series pin assignment (with u-connectXpress).....	25
4	Electrical specifications.....	28
4.1	Absolute maximum ratings	28
4.1.1	Maximum ESD ratings.....	28
4.2	Operating conditions.....	28
4.2.1	Operating temperature range.....	28
4.2.2	Supply/Power pins	29
4.2.3	Current consumption.....	29
4.2.4	RF performance	32
4.2.5	Throughput characteristics	32
4.2.6	Latency	32
4.2.7	Antenna radiation patterns.....	33
4.2.8	Low frequency crystal.....	37
4.2.9	RESET_N pin.....	37
4.2.10	Digital pins.....	37
4.2.11	I2C pull-up resistor values.....	38
4.2.12	Analog comparator.....	38
5	Mechanical specifications.....	39

5.1	NINA-B3x1 mechanical specification	39
5.2	NINA-B3x2 mechanical specification	41
5.3	NINA-B3x6 mechanical specification	43
6	Qualification and approvals	45
6.1	Compliance with the RoHS directive.....	45
6.2	Country approvals.....	45
6.3	Bluetooth qualification.....	45
7	Product handling	46
7.1	Packaging	46
7.1.1	Reels	46
7.1.2	Tapes.....	46
7.2	Moisture sensitivity levels.....	48
7.3	Reflow soldering	48
7.4	ESD precautions.....	48
8	Labeling and ordering information	49
8.1	Product labeling.....	49
8.1.1	Product identifiers.....	50
8.1.2	Identification codes.....	50
8.2	Ordering information.....	51
Appendix	52
A	Glossary	52
Related documents	53
Revision history	53
Contact	54

1 Functional description

1.1 Overview

NINA-B3 series modules are small stand-alone Bluetooth 5 low energy modules featuring full Bluetooth 5 support, a powerful Arm® Cortex®-M4 with FPU, and state-of-the-art power performance. The embedded low power crystal improves power consumption by enabling optimal power save modes.

The NINA-B3 series includes two sub-series, as described in [Table 1](#).

Model	Description
NINA-B30 series	<p>Bluetooth 5 module with a powerful Arm Cortex-M4 with FPU, and state-of-the-art power performance. All variants of NINA-B30 are open CPU modules that enable customer applications to run on the built-in Arm Cortex-M4 with FPU. With 1 MB flash and 256 kB RAM, they offer the best-in-class capacity for customer applications on top of the Bluetooth low energy stack.</p> <p>NINA-B301 has a pin for use with an external antenna, NINA-B302 comes with an internal PIFA antenna, and NINA-B06 has an internal PCB antenna integrated in the module PCB. The internal antennas are specifically designed for the small NINA form factor and provide an extensive range, independent of ground plane and component placement.</p>
NINA-B31 series	<p>Bluetooth 5 module with a powerful Arm Cortex-M4 with FPU and u-connectXpress software pre-flashed. The u-connectXpress software in NINA-B31 modules provides support for u-blox Bluetooth low energy Serial Port Service, GATT client and server, beacons, NFC™, and simultaneous peripheral and central roles – all configurable from a host using AT commands. NINA-B31x modules provide top grade security, thanks to secure boot, which ensures the module only boots up with original u-blox software.</p> <p>NINA-B311 has a pin for use with an external antenna, NINA-B312 comes with an internal PIFA antenna, and NINA-B16 has an internal PCB antenna integrated in the module PCB. The internal antennas are specifically designed for the small NINA form factor and provide an extensive range, independent of ground plane and component placement.</p>

Table 1: NINA-B3 module series

NINA-B3 series modules are globally certified for use with the internal antenna or a range of external antennas. This greatly reduces time, cost, and effort for customers integrating these modules in their designs. A list of antennas approved for use with NINA-B3 modules is maintained in the system integration manual [\[3\]](#).

1.2 Applications

- Industrial automation
- Smart buildings and cities
- Low power sensors
- Wireless-connected and configurable equipment
- Point-of-sales
- Health devices

1.3 Product features

1.3.1 NINA-B30 series

	NINA-B301	NINA-B302	NINA-B306
Grade			
Automotive			
Professional	•	•	•
Standard			
Radio			
Bluetooth qualification	v5.0	v5.0	v5.0
Bluetooth profiles	G	G	G
Bluetooth output power EIRP [dBm]	10	10	10
Max range [meters]	1400	1400	1400
NFC for “Touch to Pair”	•	•	•
Antenna type	p	i	b
Application software			
Open CPU for embedded customer applications	•	•	•
Interfaces			
UART	◆	◆	◆
SPI	◆	◆	◆
I ² C	◆	◆	◆
I ² S	◆	◆	◆
USB	◆	◆	◆
GPIO pins	38	38	38
AD converters (ADC)	◆	◆	◆
Features			
GATT server and client	◆	◆	◆
Throughput [Mbit/s]	1.4	1.4	14
Maximum Bluetooth connections	20	20	20
Secure boot	◆	◆	◆
Mesh networking	◆	◆	◆
FOTA	◆	◆	◆

G = GATT
 p = Antenna pin
 i = Internal PIFA antenna
 b = Internal PCB antenna
 ◆ = Feature enabled by HW. The actual support depends on the open CPU application SW.

Table 2: NINA-B30 series main features summary

1.3.2 NINA-B31 series

	NINA-B311	NINA-B312	NINA-B316
Grade			
Automotive			
Professional	•	•	•
Standard			
Radio			
Chip inside	nRF52840		
Bluetooth qualification	v5.0	v5.0	v5.0
Bluetooth low energy	•	•	•
Bluetooth output power EIRP [dBm]	10	10	10
Max range [meters]	1400	1400	1400
NFC	•	•	•
Antenna type (see footnotes)	pin	metal	pcb
Application software			
u-connectXpress	•	•	•
Interfaces			
UART	2	2	2
GPIO pins	28	28	28
Features			
AT command interface	•	•	•
Simultaneous GATT server and client	•	•	•
Low Energy Serial Port Service	•	•	•
Throughput [Mbit/s]	0.8	0.8	0.8
Maximum Bluetooth connections	8	8	8
Secure boot	•	•	•
Bluetooth mesh	•	•	•

pin = Antenna pin
pcb = Internal PCB antenna

metal = Internal metal PIFA antenna

Table 3: NINA-B31 series main features summary

1.4 Block diagram

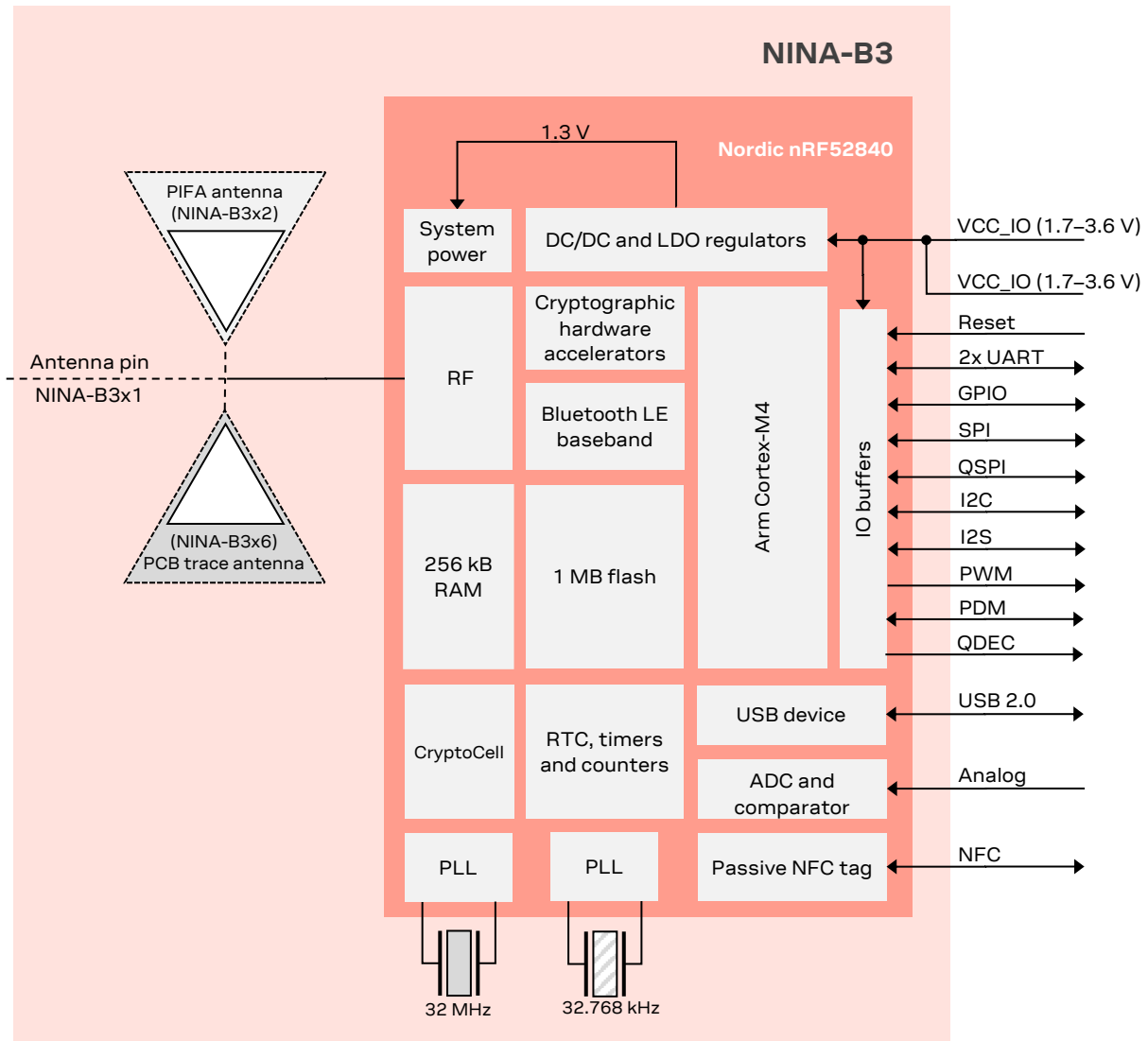

Figure 1: Block diagram of NINA-B3 series. 32.768 kHz crystal is not included in NINA-B306-01B. With u-connectXpress (NINA-B31 module variants) a subset of the interfaces is available.

1.4.1 NINA-B3x1

NINA-B3x1 modules do not include an internal antenna, and thus the PCB has been trimmed to allow for a smaller module (10.0 x 11.6 mm). Instead of an internal antenna, the RF signal is available at a module pin for routing to an external antenna or antenna connector.

1.4.2 NINA-B3x2

NINA-B3x2 modules include an internal metal sheet PIFA antenna mounted on the PCB (10.0 x 15.0 mm). The RF signal pin is not connected to any signal path.

1.4.3 NINA-B3x6

NINA-B3x6 modules include an internal PCB antenna integrated in the module PCB, using antenna technology from Abracon. The module PCB is 10.0 x 15.0 mm. The RF signal pin is not connected to any signal path.

1.5 Product description

Item	NINA-B3x1	NINA-B3x2	NINA-B3x6
Bluetooth version	5.0	5.0	5.0
Band support	2.4 GHz, 40 channels	2.4 GHz, 40 channels	2.4 GHz, 40 channels
Typical conducted output power	+7.5 dBm	+8 dBm	+8 dBm
Radiated output power (EIRP)	+10.5 dBm (with approved antennas)	+10 dBm	+10 dBm
RX sensitivity (conducted)	-94 dBm	-94 dBm	-94 dBm
RX sensitivity, long range mode (conducted)	-100 dBm	-100 dBm	-100 dBm
Supported 2.4 GHz radio modes	Bluetooth Low Energy IEEE 802.15.4 ¹ Proprietary 2.4 GHz modes ¹	Bluetooth Low Energy IEEE 802.15.4 ¹ Proprietary 2.4 GHz modes ¹	Bluetooth Low Energy IEEE 802.15.4 ¹ Proprietary 2.4 GHz modes ¹
Supported Bluetooth Low Energy data rates	1 Mbps 2 Mbps 500 kbps 125 kbps	1 Mbps 2 Mbps 500 kbps 125 kbps	1 Mbps 2 Mbps 500 kbps 125 kbps
Module size	10.0 x 11.6 mm	10.0 x 15.0 mm	10.0 x 15.0 mm

Table 4: NINA-B3 series characteristics summary

1.6 Hardware options

Except for the different PCB sizes and antenna solutions, the NINA-B3 series modules use an identical hardware configuration. An on-board 32.768 kHz crystal is included as well as an integrated DC/DC converter for higher efficiency under heavy load situations. See also [Module supply input \(VCC\)](#).

 The 32.768 kHz crystal is not included in the NINA-B306-01B variant.

1.7 Software options

The integrated application processor of the NINA-B3 module is an Arm Cortex-M4 with FPU that has 1 MB flash memory and 256 kB RAM. The NINA-B31 series modules support additional external memory that can be connected to the Quad Serial Peripheral Interface (QSPI). See also [Quad serial peripheral interface \(QSPI\)](#).

The software structure of any program running on the module can be broken down into the following components:

- Radio stack
- Bootloader (optional)
- Application

¹ Open CPU variant NINA-B30 variants only

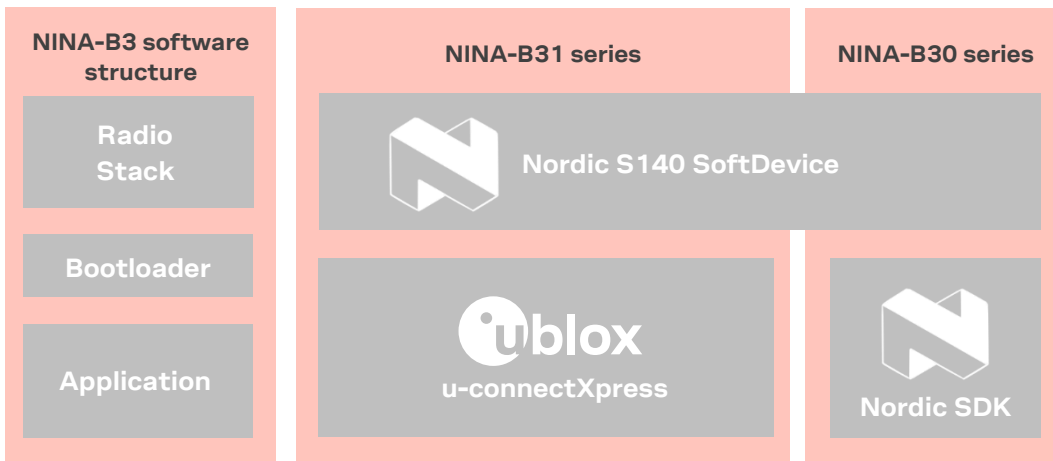

Figure 2: NINA-B3 software structure and available software options

1.7.1 u-connectXpress software

NINA-B31 series modules are pre-flashed with u-connectXpress software and are delivered with the u-blox secure boot loader.

The u-connectXpress software enables use of the Bluetooth Low Energy functions, controlled by AT commands over the UART interface. Examples of supported features are u-blox Low Energy Serial Port Service, GATT server and client, central and peripheral roles, and multidrop connections. NINA-B31 modules can be configured with AT commands or using the u-blox s-center evaluation software, which can be downloaded from the [u-blox](#) website and is available free of charge.

For more about the features, capabilities and use of the u-connectXpress software, see also the u-connectXpress AT commands manual [2] and u-connectXpress software user guide [4].

1.7.2 Open CPU

The open CPU architecture in the NINA-B30 series modules allows the module integrator to build their own applications.



u-blox recommends the Nordic Semiconductors nRF5 Software Development Kit (SDK) for application development. The SDK provides a rich and well-tested software development environment for nRF52 based devices and offers a broad selection of drivers, libraries, and example applications. It also includes other radio stacks.

NINA-B3 series modules are certified for use with any radio stack, though only the Nordic S140 SoftDevice is allowed in Bluetooth products. [Contact](#) your local u-blox support team if you would like to use another 2.4 GHz radio protocol.

1.8 Bluetooth device address

Each NINA-B3 module is pre-programmed with a unique 48-bit Bluetooth device address. If the memory of a NINA-B30 module becomes corrupted or otherwise lost, the address can be recovered from the data matrix barcode printed on the module label.

2 Interfaces

-  NINA-B30 series (open CPU): All interfaces/features described in this section are available.
-  NINA-B31 series (u-connectXpress): All interfaces/features described in this section are available in hardware, but only a subset is supported by the u-connectXpress software. See the latest u-connectXpress documentation [2] [4] and release notes for details about the features supported by the current software release. Support for additional interfaces may be added in future software releases.

2.1 Power management

2.1.1 Module supply input (VCC)

NINA-B3 series uses integrated step-down converters to transform the supply voltage presented at the **VCC** pin into a stable system voltage. This makes NINA-B3 modules compatible for use in battery-powered designs without the use of an additional voltage converter. You can choose one of the following two on-board voltage converter options:

- A low-dropout (LDO) converter
- A DC/DC buck converter

Normally, the module will automatically switch between these options depending on the current consumption of the module. Under high loads such as when the radio is active, the DC/DC converter is more efficient, while the LDO converter is more efficient in the power saving modes.

2.1.2 Digital I/O interfaces reference voltage (VCC_IO)

All modules in the NINA series provide an additional voltage supply input for setting the I/O voltage level. The I/O voltage level in NINA-B3 series modules is similar to the supply voltage and **VCC_IO** is internally connected to the supply input. This means that only a single supply voltage is needed, which makes NINA-B3 ideal for battery powered designs.

-  This may not be the case for other modules in the NINA series. A design intended to be pin compatible with other NINA-series modules should keep the **VCC** and **VCC_IO** supply rails separate.

2.2 RF antenna interfaces

2.2.1 2.4 GHz radio (ANT)

NINA-B3 model versions have their own 2.4 GHz antenna solutions:

- NINA-B3x1 modules provide an antenna pin (**ANT**) with a nominal characteristic impedance of 50 Ω. This pin can be connected to an onboard antenna or antenna connector using a controlled impedance trace.
- NINA-B3x2 modules use an integrated antenna solution; no additional components are required. The antenna is a metal sheet PIFA antenna that makes the module insensitive to placement on the carrier board or the size of the carrier board, when compared to other integrated antenna solutions. The **ANT** pin is internally disconnected on these models.
- NINA-B3x6 modules use an internal PCB antenna integrated into the module PCB. This low-profile antenna solution is useful in space constrained designs. The **ANT** pin is internally disconnected on these models. This solution uses antenna technology licensed from Abracon.

 For Antenna reference designs and integration instructions, see also the NINA-B3 system integration manual [3].

2.2.2 Near Field Communication (NFC)

NINA-B3 series modules include a Near Field Communication interface, capable of operating as a 13.56 MHz NFC tag at a bit rate of 106 kbps. As an NFC tag, the data can be read from or written to the NINA-B3 modules using an NFC reader; however, NINA-B3 modules are not capable of reading other tags or initiating NFC communications.

NINA-B30 Open CPU modules can be triggered to wake-up using commands over the NFC interface. This allows modules to be kept in the deepest sleep mode, triggered to wake up, and then react to devices in the NFC field. It is not possible to wake up NINA-B31 modules from deep sleep mode over the NFC interface using u-connectXpress software.

Two pins are available for connecting to an external NFC antenna: **NFC1** and **NFC2**.

2.3 System functions

NINA-B3 series modules are power efficient devices capable of operating in different power saving modes and configurations. Different sections of the module can be powered off when not needed and complex wake-up events can be generated from different external and internal inputs. The radio part of the module operates independently from the CPU. The three main power modes are:

- Active
- Standby
- Sleep

Depending on the application, the module should spend most of its time in either standby or sleep mode to minimize current consumption.

2.3.1 Module power-on

You can switch on or reboot the NINA-B3 modules in one of the following ways:

- Rising edge on the VCC pin to a valid supply voltage
- Issuing a reset of the module. See also [Module reset](#).

An event to wake up from the sleep mode to the active mode can be triggered by:

- A programmable digital or analog sensor event. For example, rising voltage level on an analog comparator pin
- Detecting an NFC field
- Supplying 5 V to the **VBUS** pin (plugging in the USB interface)

While waking up from the standby mode to active mode, an event can also be triggered by:

- The on-board Real Time Counter (RTC)
- The radio interface

2.3.2 Module power off

There is no dedicated pin to power off the NINA-B3 modules. You can configure any GPIO pin to enter or exit the [sleep mode](#), which essentially powers down the module.

An under-voltage (brown-out) shutdown occurs on the NINA-B3 modules when the **VCC** supply drops below the operating range minimum limit. If this occurs, it is not possible to store the current parameter settings in the non-volatile memory of the module.

2.3.3 Standby mode

Standby mode is one of the power saving modes in NINA-B3 modules that essentially powers down the module but keeps the system RAM and configurations intact. It also allows for complex, autonomous power-up events, including periodic RTC events and radio events.

The following events can be used to bring the module out of the standby mode:

- Internal wake-up events from the RTC, radio, NFC and so on.
- Analog or digital sensor events (programmable voltage level or edge detection)

During standby mode, the module is clocked at 32 kHz, which is generated by an internal 32 kHz crystal oscillator.

2.3.4 Sleep mode

Sleep mode is the deepest power saving mode of NINA-B3 modules. During sleep mode, all functionality is stopped to ensure minimum power consumption. The module needs an external event to wake up from the sleep mode. The module always reboots after waking up from the sleep mode, and different sections of the RAM can be configured to remain intact during and after going to the sleep mode.

The following events can be used to wake up the module from sleep mode:

- External event on a digital pin
- External analog event on a low power comparator pin
- Detection of an NFC field

When using the u-connectXpress software, the module can be manually switched on or off with proper storage of the current settings using the UART **DSR** pin.

The module can be programmed to latch the digital values present at its GPIO pins during sleep. The module keeps the values latched, and a change of state on any of these pins triggers a wake-up to active mode.

2.3.5 Module reset

NINA-B3 modules can be reset using one of the following ways:

- Low level on the **RESET_N** input pin, normally kept high using an internal pull-up. This causes an “external” or “hardware” reset of the module. The current parameter settings are not saved in the module’s non-volatile memory and a proper network detach is not performed.
- Using the `AT+CPWROFF` command. This causes an “internal” or “software” reset of the module. The current parameter settings are saved in the module’s non-volatile memory and a proper network detach is performed.

2.3.6 CPU and memory

The Nordic Semiconductor nRF52840 chip in the NINA-B3 series modules includes a powerful Arm Cortex M4 processor. The processor works with a superset of 16 and 32-bit instructions (Thumb-2) at 64 MHz clock speed. It can use up to 37 interrupt vectors and 3 priority bits.

The nRF52840 chip has 1 MB of flash and 256 KB of RAM for code and data storage. Additionally, up to 4 GB of external memory can be addressed with Execute in Place (XIP) support over the QSPI interface. See also [sleep mode](#).

2.3.7 Direct Memory Access

All interfaces described in this data sheet support Direct Memory Access (DMA), which allows any data generated from the interface to be moved directly into the RAM – without involving the CPU. This ensures fluent operation of the CPU with minimal need for interruption. To reduce the overall power consumption, DMA should be used as often as possible.

2.3.8 Programmable Peripheral Interconnect

The Nordic Semiconductor nRF52840 chip in the NINA-B3 series modules include a programmable peripheral interconnect (PPI), which is basically a switch matrix that connects various control signals between different interfaces and system functions. This allows most interfaces to bypass the CPU in order to trigger a system function, which means that an incoming data packet may trigger a counter on a falling voltage level on an ADC or toggle a GPIO without having to send an interrupt to the CPU. This makes it possible to develop smart, power-efficient applications that wake up the CPU only when necessary.

2.3.9 Real Time Counter (RTC)

A key system feature available on the module is the Real Time Counter. This counter can generate multiple interrupts and events to the CPU and radio as well as internal and external hardware blocks. These events can be precisely timed ranging from microseconds up to hours. The events allow for periodic Bluetooth Low Energy advertising events, and so on – without involving the CPU. The RTC can be operated in the active and standby modes.

2.4 Serial interfaces

NINA-B3 modules support the following serial communication interfaces:

- 2x UART interfaces: 4-wire universal asynchronous receiver/transmitter interface used for AT command interface, data communication, and u- connect software upgrades using the Software update `+UFWUPD` AT command.
- 3x SPI interfaces: Up to three serial peripheral interfaces can be used simultaneously.
- 1x QSPI interface: High speed interface used to connect to the external flash memories.
- 2x I2C interfaces: Inter-Integrated Circuit (I2C) interface for communication with digital sensors.
- 1x I2S interface: Used to communicate with external audio devices.
- 1x USB 2.0 interface: The USB device interface to connect to the upstream host.

 Most digital interface pins on the module are shared between the digital interfaces, analog interfaces, and GPIOs. Unless otherwise stated, all functions can be assigned to any pin that is not already occupied.

 Two of the SPI interfaces share common hardware with the I2C interfaces, which cannot be used simultaneously. That is, if both I2C interfaces are in use then only one SPI interface is available.

2.4.1 Universal Asynchronous Receiver/Transmitter (UART)

The 4-wire UART interface supports hardware flow control and baud rates up to 1 Mbps. Other characteristics of the UART interface are listed below:

- Pin configuration:
 - TXD, data output pin
 - RXD, data input pin
 - RTS, Request To Send, flow control output pin (optional)
 - CTS, Clear To Send, flow control input pin (optional)
- Hardware flow control or no flow control (default) is supported.

- Power saving indication available on the hardware flow control output (**RTS** pin): The line is driven to the OFF state when the module is not ready to accept data signals.
- Programmable baud rate generator allows most industry standard rates, as well as non-standard rates up to 1 Mbps.
- Frame format configuration:
 - Eight (8) data bits
 - Even or no-parity bit
 - One (1) stop bit
- 8N1 default frame configuration:
 - Eight (8) data bits
 - No (N) parity bit
 - One (1) stop bit
- Frames are transmitted in such a way that the least significant bit (LSB) is transmitted first.

2.4.2 Serial peripheral interface (SPI)

NINA-B3 supports up to three Serial Peripheral Interfaces with serial clock frequencies of up to 8 MHz. Characteristics of the SPI interfaces are listed below:

- Pin configuration in master mode:
 - SCLK, Serial clock output, up to 8 MHz
 - MOSI, Master Output Slave Input data line
 - MISO, Master Input Slave Output data line
 - CS, Chip/Slave select output, active low, selects which slave on the bus to talk to. Only one select line is enabled by default but more can be added by customizing a GPIO pin.
 - DCX, Data/Command signal, this signal is optional but is sometimes used by the SPI slaves to distinguish between SPI commands and data
- Pin configuration in slave mode:
 - SCLK, Serial clock input
 - MOSI, Master Output Slave Input data line
 - MISO, Master Input Slave Output data line
 - CS, Chip/Slave select input, active low, connects/disconnects the slave interface from the bus.
- Both master and slave modes are supported on all the interfaces.
- The serial clock supports both normal and inverted clock polarity (CPOL) and data should be captured on rising or falling clock edge (CPHA).

2.4.3 Quad serial peripheral interface (QSPI)

The Quad Serial Peripheral Interface enables external memory to be connected to the NINA-B3 module to increase the application program size. The QSPI supports “Execute In Place (XIP)”, which allows CPU instructions to be read and executed directly from the external memory (128 MB at a time with a programmable offset). Characteristics for the QSPI include:

- The QSPI always operates in master mode and uses the following pin configuration:
 - CLK, serial clock output, up to 32 MHz
 - CS, Chip/Slave select output, active low, selects which slave on the bus to talk to
 - D0, MOSI serial output data in single mode, data I/O signal in dual/quad mode
 - D1, MISO serial input data in single mode, data I/O signal in dual/quad mode
 - D2, data I/O signal in quad mode (optional)
 - D3, data I/O signal in quad mode (optional)
- Single/dual/quad read and write operations (1/2/4 data signals)
- Clock speeds between 2–32 MHz
- Data rates up to 128 Mbit/s in the quad mode
- 32 bit addressing can address up to 4 GB of data

- Instruction set includes support for deep power down mode of the external flash
- Possible to generate custom flash instructions containing a 1-byte opcode and up to 8 bytes of additional data and read its response

2.4.4 Inter-Integrated Circuit interface (I2C)

The Inter-Integrated Circuit (I2C) interfaces can be used to transfer and/or receive data on a 2-wire bus network. NINA-B3 modules can operate as both master and slave on the I2C bus using standard (100 kbps), fast (400 kbps), and 250 kbps transmission speeds. The interface supports clock stretching, which means that NINA-B3 can temporarily pause I2C communications. Up to 127 individually addressable I2C devices can be connected to the same two signals.

- Pin configuration:
 - SCL, clock output in master mode, input in slave mode
 - SDA, data input/output pin

This interface requires external pull-up resistors to work properly in master mode. See also [I2C pull-up resistor values](#). The pull-up resistors are also required in slave mode but these should be placed at the master-end of the interface.

2.4.5 Inter-IC Sound interface (I2S)

The Inter-IC Sound (I2S) interface can be used to transfer audio sample streams between NINA-B3 and external audio devices such as codecs, DACs, and ADCs. It supports original I2S and left or right-aligned interface formats in both master and slave modes.

- Pin configuration:
 - MCK, Master clock
 - LRCK, Left Right/Word/Sample clock
 - SCK, Serial clock
 - SDIN, Serial data in
 - SDOUT, Serial data out

The Master side of an I2S interface always provides the **LRCK** and **SCK** clock signals, but some master devices cannot generate a **MCK** clock signal. NINA-B3 can supply a **MCK** clock signal in both master and slave modes to provide to those external systems that cannot generate their own clock signal. The two data signals - **SDIN** and **SDOUT** allow for simultaneous bi-directional audio streaming. The interface supports 8, 16, and 24-bit sample widths with up to 48 kHz sample rate.

2.4.6 USB 2.0 interface

NINA-B3 series modules include a full-speed Universal Serial Bus (USB) device interface that is compliant to version 2.0 of the USB specification. Characteristics of the USB interface include:

- Full-speed device up to 12 Mbit/s transfer speed
- MAC and PHY implemented in the hardware
- Pin configuration:
 - **VBUS**, 5 V supply input, required to use the interface
 - **USB_DP**, **USB_DM**, differential data pair
- Automatic or software-controlled pull up of the **USB_DP** pin

The USB interface has a dedicated power supply that requires a 5 V supply voltage to be applied to the **VBUS** pin. This allows the USB interface to be used even though the rest of the module might be battery powered or supplied by a 1.8 V supply etc.

2.5 Digital interfaces

2.5.1 Pulse Width Modulation (PWM)

NINA-B3 modules provide a 4x four channel pulse width modulator (PWM) unit with EasyDMA, that can be used to generate complex waveforms. These waveforms can be used to control motors, dim LEDs, or used as audio signals when connected to speakers. Duty-cycle sequences may be stored in the RAM to be chained and looped into complex sequences without CPU intervention. Each channel uses a single GPIO pin as output.

2.5.2 Pulse Density Modulation (PDM)

The pulse density modulation interface is used to read signals from external audio frontends like digital microphones. It supports single or dual-channel (left and right) data input over a single GPIO pin. It also supports up to 16 kHz sample rate and 16-bit samples. The interface uses the DMA to automatically move the sample data into RAM without CPU intervention. The interface uses two signals: **CLK** to output the sample clock and **DIN** to read the sample data.

2.5.3 Quadrature Decoder (QDEC)

The quadrature decoder is used to read quadrature encoded data from mechanical and optical sensors in the form of digital waveforms. Quadrature encoded data is often used to indicate rotation of a mechanical shaft in either a positive or negative direction. The QDEC uses two inputs, **PHASE_A** and **PHASE_B**, and an optional **LED** output signal. The interface has a selectable sample period ranging from 128 μ s to 131 ms.

2.6 Analog interfaces

8 out of the 38 digital GPIOs can be multiplexed to analog functions. The following analog functions are available:

- 1x 8-channel ADC
- 1x Analog comparator*
- 1x Low-power analog comparator*

*Only one comparator can be used at any given point of time.

2.6.1 Analog to Digital Converter (ADC)

The Analog to Digital Converter (ADC) is used to sample an analog voltage on the analog function enabled pins of the NINA-B3. Any of the 8 analog inputs can be used. Characteristics of the ADC include:

- Full swing input range of 0 V to **VCC**
- 8/10/12-bit resolution
- 14-bit resolution while using oversampling
- Up to 200 kHz sample rate
- Single shot or continuous sampling
- Two operation modes: Single-ended or Differential
- Single-ended mode:
 - A single input pin is used
- Differential mode:
 - Two inputs are used and the voltage level difference between them is sampled

If the sampled signal level is much lower than the **VCC**, it is possible to lower the input range of the ADC to better encompass the wanted signal and achieve a higher effective resolution. Continuous sampling can be configured to sample at a configurable time interval, or at different internal or external events – without CPU involvement.

2.6.2 Comparator

The analog comparator compares the analog voltage on one of the analog enabled pins in NINA-B3 with a highly configurable internal or external reference voltage. Events can be generated and distributed to the rest of the system when the voltage levels cross. Further characteristics of the comparator include:

- Full swing input range of 0 V to VCC
- Two operation modes: Single-ended or Differential
- Single-ended mode:
 - A single reference level or an upper and lower hysteresis selectable from a 64-level reference ladder with a range from 0 V to VREF, as described in [Table 5](#)
- Differential mode:
 - Two analog pin voltage levels are compared, optionally with a 50 mV hysteresis
- Three selectable performance modes - High speed, balanced, or power save

For a comparison of the various analog comparator options, see also [Analog comparator](#).

2.6.3 Low power comparator

In addition to the power save mode available for the comparator, there is a separate low power comparator available on the NINA-B3 module. This allows for even lower power operation at a slightly lower performance with fewer configuration options.

Characteristics of the low power comparator include:

- Full swing input range of 0 to **VCC**.
- Two operation modes - Single-ended or Differential
- Single-ended mode:
 - The reference voltage LP_VIN- is selected from a 15-level reference ladder
- Differential mode:
 - Pin **GPIO_16** or **GPIO_18** is used as reference voltage LP_VIN-
- Can be used to wake the system from sleep mode

[Table 5](#) shows the analog pin options. For a comparison of the various analog comparator options, see also [Analog comparator](#). Since the run current of the low power comparator is very low, it can be used in the module [sleep mode](#) as an analog trigger to wake up the CPU.

2.6.4 Analog pin options

[Table 5](#) shows the supported connections of the analog functions.



An analog pin may not be simultaneously connected to multiple functions.

Symbol	Analog function	Can be connected to
ADCP	ADC single-ended or differential positive input	Any analog pin or VCC
ADCN	ADC differential negative input	Any analog pin or VCC
VIN+	Comparator input	Any analog pin
VREF	Comparator single-ended mode reference ladder input	Any analog pin, VCC , 1.2 V, 1.8V or 2.4V
VIN-	Comparator differential mode negative input	Any analog pin
LP_VIN+	Low-power comparator IN+	Any analog pin

Symbol	Analog function	Can be connected to
LP_VIN-	Low-power comparator IN-	GPIO_16 or GPIO_18 , 1/16 to 15/16 VCC in steps of 1/16 VCC

Table 5: Possible uses of the analog pins

2.7 GPIO

NINA-B3 series modules are versatile concerning pin-out. In an un-configured state, there are 38 GPIO pins in total and no analog or digital interfaces. All interfaces or functions must then be allocated to a GPIO pin before use. 8 out of the 38 GPIO pins are analog-enabled, which means that they can have an analog function allocated to them. In addition to the serial interfaces, [Table 6](#) shows the number of digital and analog functions that can be assigned to a GPIO pin.

2.7.1 Drive strength

All GPIO pins are normally configured for low current consumption. Using this standard drive strength, a pin configured as output can only source or sink a certain amount of current. For example, if the timing requirements of a digital interface cannot be met, or if an LED requires more current, a high drive strength mode is available, which allows the digital output to draw more current. See also [Digital pins](#).

Function	Description	Default NINA pin	Configurable GPIOs
General purpose input	Digital input with configurable pull-up, pull-down, edge detection and interrupt generation		Any
General purpose output	Digital output with configurable drive strength, push-pull, open collector or open emitter output		Any
Pin disabled	Pin is disconnected from the input and output buffers	All*	Any
Timer/ counter	High precision time measurement between two pulses/ Pulse counting with interrupt/event generation		Any
Interrupt/ Event trigger	Interrupt/event trigger to the software application/ Wake up event		Any
HIGH/LOW/Toggle on event	Programmable digital level triggered by internal or external events without CPU involvement		Any
ADC input	8/10/12/14-bit analog to digital converter		Any analog
Analog comparator input	Compare two voltages, capable of generating wake-up events and interrupts		Any analog
PWM output	Output simple or complex pulse width modulation waveforms		Any
Connection status indication	Indicates if a Bluetooth Low Energy connection is maintained	BLUE**	Any

* = If left unconfigured

** = While using the u-connectXpress software

Table 6: GPIO custom functions configuration

2.8 u-connectXpress software features

This section describes some of the system related features in the u-connectXpress software. See also the u-connectXpress AT commands manual [\[2\]](#) and u-connectXpress software user guide [\[4\]](#).

2.8.1 u-blox Serial Port Service (SPS)

The serial port service feature enables serial port emulation over Bluetooth Low Energy (LE).

2.8.2 System status signals

The **RED**, **GREEN**, and **BLUE** pins are used to signal the system status, as shown in [Table 7](#). The pins are active-low and meant to be routed to an RGB LED.

Mode	Status	RGB LED Color	RED	GREEN	BLUE
Data mode/Extended Data mode (EDM)	IDLE	Green	HIGH	LOW	HIGH
Command mode	IDLE	Orange	LOW	LOW	HIGH
EDM/Data mode, Command mode	CONNECTING	Purple	LOW	HIGH	LOW
EDM/Data mode, Command mode	CONNECTED*	Blue	HIGH	HIGH	LOW

* = LED flashes on data activity

Table 7: System status indication

 CONNECTING and CONNECTED status indicate u-blox SPS connections.

2.8.3 System control signals

The following input signals are used to control the system: **RESET_N**, **SWITCH_1** and **SWITCH_2**.

- **RESET_N** is used to reset the system. See also [Module reset](#).
- If **SWITCH_2** is driven low during startup, the UART serial settings are restored to their default values.
- **SWITCH_2** can be used to open a Bluetooth LE connection with a peripheral device.
- If both **SWITCH_1** and **SWITCH_2** are driven low during startup, the system enters bootloader mode.
- If both **SWITCH_1** and **SWITCH_2** are driven low during startup and then held low for 10 seconds, the system exits the bootloader mode and restores all settings to their factory default.

2.8.4 UART

Two UART interfaces may be used on NINA-B3: one primary and one secondary interface.

 See also the u-connectXpress AT commands manual [\[2\]](#) and u-connectXpress software user guide [\[4\]](#).

2.8.4.1 Primary UART interface

The primary interface is used for communication with NINA-B3 from a host controller. It is used to configure NINA-B3 and to transmit or receive data to or from a Bluetooth LE link or any sensors that are connected. The primary interface has a fixed pin configuration that may not be changed.

In addition to the normal **RXD**, **TXD**, **CTS**, and **RTS** signals described in [Universal Asynchronous Receiver/Transmitter \(UART\)](#), the u-connectXpress software adds the **DSR** and **DTR** pins to the UART interface. Note that these pins are not used as they were originally intended, but instead control the state of the NINA module.

Depending on the current configuration, the **DSR** pin can be used to:

- Enter the command mode
- Disconnect and/or toggle connectable status
- Enable/disable the rest of the UART interface
- Enter/wake up from the sleep mode

The **DTR** pin can be used to indicate:

- The System mode
- If the SPS peers are connected
- If a Bluetooth LE bonded device is connected
- A Bluetooth LE GAP connection

2.8.4.2 Secondary UART interface

 A secondary UART interface is available on u-connectXpress software versions 3.0 and onwards.

The secondary UART interface can be used to “daisy chain” UART connections. It is useful in resource constrained systems where the host controller only has one UART interface available. To use it, the NINA-B3 module is configured to become a UART bridge, and UART data sent over the primary UART interface flows into the secondary UART interface.



Figure 3: Example use case of the secondary UART interface

The secondary UART interface pins can be freely configured to any free NINA GPIO pin. It uses four signals: **RXD**, **TXD**, **CTS** and **RTS**. See also [Universal Asynchronous Receiver/Transmitter \(UART\)](#).

2.9 Debug interfaces

2.9.1 SWD

NINA-B30 series modules provide an SWD interface for flashing and debugging. The SWD interface consists of two pins, **SWDCLK** and **SWDIO**. The SWD interface is disabled on the NINA-B31 series modules.

2.9.2 Trace – Serial Wire Output

A serial trace option is available on the NINA-B30 series modules as an additional pin, **SWO**. The Serial Wire Output (SWO) is used to:

- Support printf style debugging
- Trace OS and application events
- Emit diagnostic system information

A debugger that supports Serial Wire Viewer (SWV) is required.

2.9.3 Parallel Trace

NINA-B30 series modules support parallel trace output as well. This allows output from the Embedded Trace Macrocell (ETM) and Instrumentation Trace Macrocell (ITM) embedded in the Arm Cortex-M4 core of the nRF52840 chip in the NINA-B3. The ETM trace data allows a user to record exactly how the application goes through the CPU instructions in real time. The parallel trace interface uses 1 clock signal and 4 data signals respectively - **TRACE_CLK**, **TRACE_D0**, **TRACE_D1**, **TRACE_D2** and **TRACE_D3**.

No.	Name	I/O	Description	nRF52 pin	Remarks
1	GPIO_1	I/O	General purpose I/O	P0.13	
2	GPIO_2	I/O	General purpose I/O	P0.14	
3	GPIO_3	I/O	General purpose I/O	P0.15	
4	GPIO_4	I/O	General purpose I/O	P0.16	
5	GPIO_5	I/O	General purpose I/O	P0.24	
6	GND	-	Ground		
7	GPIO_7	I/O	General purpose I/O	P0.25	
8	SWO/TRACE_D0/ GPIO_8	I/O	General purpose I/O	P1.00	May be used for parallel/serial trace debug
9	VCC_IO	I	Module I/O level voltage input		Must be connected to VCC on NINA-B3
10	VCC	I	Module supply voltage input		1.7-3.6 V range
11	SWDCLK	I	Serial Wire Debug port clock signal	SWDCLK	
12	GND	-	Ground		
13	ANT	I/O	Tx/Rx antenna interface		50 Ω nominal characteristic impedance, only used with NINA-B301 modules
14	GND	-	Ground		
15	SWDIO	I/O	Serial Wire Debug port data signal	SWDIO	
16	GPIO_16	I/O	Analog function enabled GPIO	P0.03	Pin is analog capable, radio sensitive pin ²
17	GPIO_17	I/O	Analog function enabled GPIO	P0.28	Pin is analog capable, radio sensitive pin ¹
18	GPIO_18	I/O	Analog function enabled GPIO	P0.02	Pin is analog capable, radio sensitive pin ¹
19	RESET_N	I/O	System reset input	P0.18	Active low
20	GPIO_20	I/O	Analog function enabled GPIO	P0.31	Pin is analog capable, radio sensitive pin ¹
21	GPIO_21	I/O	General purpose I/O	P1.12	Radio sensitive pin ¹
22	GPIO_22	I/O	General purpose I/O	P1.13	Radio sensitive pin ¹
23	GPIO_23	I/O	Analog function enabled GPIO	P0.29	Pin is analog capable, radio sensitive pin ¹
24	GPIO_24	I/O	Analog function enabled GPIO	P0.30	Pin is analog capable, radio sensitive pin ¹
25	GPIO_25	I/O	Analog function enabled GPIO	P0.04	Pin is analog capable
26	GND	-	Ground		
27	GPIO_27	I/O	Analog function enabled GPIO	P0.05	Pin is analog capable
28	NFC1/GPIO_28	I/O	NFC pin 1 (default)	P0.09	May be used as GPIO, radio sensitive pin ¹
29	NFC2/GPIO_29	I/O	NFC pin 2 (default)	P0.10	May be used as GPIO, radio sensitive pin ¹
30	GND	-	Ground		
31	VBUS	I	USB interface 5 V input	VBUS	Must be connected to 5 V for the USB interface to work
32	TRACE_D2/GPIO_32	I/O	General purpose I/O	P0.11	May be used for parallel trace debug
33	TRACE_D3/GPIO_33	I/O	General purpose I/O	P1.09	May be used for parallel trace debug
34	GPIO_34	I/O	General purpose I/O	P1.08	
35	GPIO_35	I/O	General purpose I/O	P1.01	Radio sensitive pin ¹
36	GPIO_36	I/O	General purpose I/O	P1.02	Radio sensitive pin ¹
37	GPIO_37	I/O	General purpose I/O	P1.03	Radio sensitive pin ¹
38	GPIO_38	I/O	General purpose I/O	P1.10	Radio sensitive pin ¹
39	GPIO_39	I/O	General purpose I/O	P1.11	Radio sensitive pin ¹
40	GPIO_40	I/O	General purpose I/O	P1.15	Radio sensitive pin ¹

² It is recommended to keep frequencies below 10 kHz, and only use standard drive strength on these digital pins.

No.	Name	I/O	Description	nRF52 pin	Remarks
41	GPIO_41	I/O	General purpose I/O	P1.14	Radio sensitive pin ¹
42	GPIO_42	I/O	General purpose I/O	P0.26	
43	GPIO_43	I/O	General purpose I/O	P0.06	
44	GPIO_44	I/O	General purpose I/O	P0.27	
45	TRACE_CLK/GPIO_45	I/O	General purpose I/O	P0.07	May be used for parallel trace debug
46	TRACE_D1/GPIO_46	I/O	General purpose I/O	P0.12	May be used for parallel trace debug
47	QSPI_D3/GPIO_47	I/O	General purpose I/O	P0.23	Recommended pin for QSPI_D3
48	QSPI_D1/GPIO_48	I/O	General purpose I/O	P0.21	Recommended pin for QSPI_D1
49	QSPI_D2/GPIO_49	I/O	General purpose I/O	P0.22	Recommended pin for QSPI_D2
50	QSPI_D0/GPIO_50	I/O	General purpose I/O	P0.20	Recommended pin for QSPI_D0
51	QSPI_CS/GPIO_51	I/O	General purpose I/O	P0.17	Recommended pin for QSPI_CS
52	QSPI_CLK/GPIO_52	I/O	General purpose I/O	P0.19	Recommended pin for QSPI_CLK
53	GND	-	Ground		
54	USB_DP	I/O	USB differential data signal	USB_DP	
55	USB_DM	I/O	USB differential data signal	USB_DM	
	EGP	-	Exposed Ground Pins		The exposed pins in the center of the module should be connected to GND
	EAGP	-	Exposed Antenna Ground Pins		Only on NINA-B306. The exposed pins underneath the antenna area should be connected to GND

Table 8: NINA-B30 series pin-out

3.2 NINA-B31 series pin assignment (with u-connectXpress)

Figure 5 shows the pin configuration used by the u-connectXpress software.

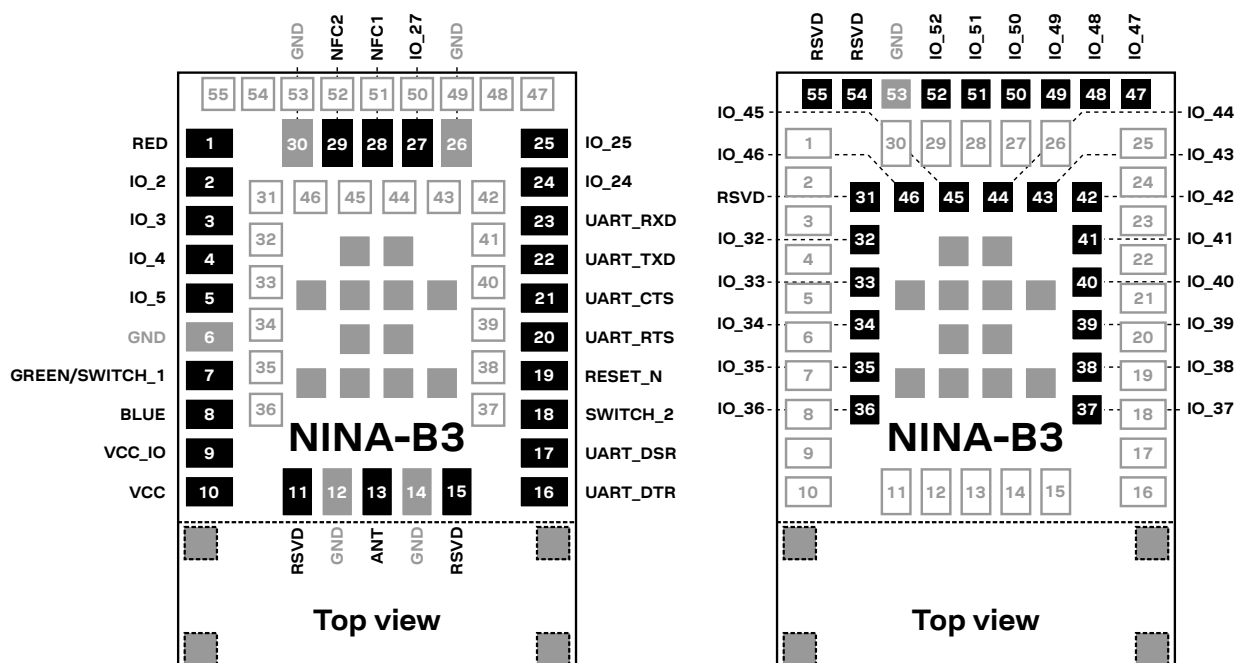



Figure 5: NINA-B31 series pin assignment (top view)

The grey pins in the center of the modules are GND pins. The outline of NINA-B311 ends at the dotted line shown in Figure 5, where the antenna area of NINA-B312 and NINA-B316 begins. The four grey pins, shown with dotted outlines in the antenna area, are GND pins and are only present on NINA-B316.

 Follow this pin layout when using the u-connectXpress software. No interfaces can be moved or added.

 Do not apply an NFC field to the NFC pins when they are configured as GPIOs as this can cause permanent damage to the module. While using the u-connectXpress software, these pins are always set in NFC mode. See also [Digital pins](#).

No.	Name	I/O	Description	Remarks
1	RED	O	RED system status signal	Active low, should be routed to an RGB LED
2	IO_2	I/O	u-connectXpress (uX) IO pin	Can be used for manual digital I/O
3	IO_3	I/O	uX IO pin	Can be used for manual digital I/O
4	IO_4	I/O	uX IO pin	Can be used for manual digital I/O
5	IO_5	I/O	uX IO pin	Can be used for manual digital I/O
6	GND	-	Ground	
7	GREEN/SWITCH_1	I/O	This signal is multiplexed: GREEN: System status signal. SWITCH_1: Multiple functions	Active low. GREEN: Should be routed to an RGB LED. SWITCH_1: See also System control signals .
8	BLUE	O	BLUE system status signal	Active low, should be routed to an RGB LED
9	VCC_IO	I	Module I/O level voltage input	Must be connected to VCC on NINA-B3
10	VCC	I	Module supply voltage input	1.7-3.6 V range
11	RSVD	-	RESERVED pin	Leave unconnected
12	GND	-	Ground	
13	ANT	I/O	Tx/Rx antenna interface	50 Ω nominal characteristic impedance, only used with NINA-B311 modules
14	GND	-	Ground	
15	RSVD	-	RESERVED pin	Leave unconnected
16	UART_DTR	O	UART data terminal ready signal	Used to indicate system status
17	UART_DSR	I	UART data set ready signal	Used to change the system modes
18	SWITCH_2	I	Multiple functions	Active low. See also System control signals .
19	RESET_N	I	External system reset input	Active low
20	UART_RTS	O	UART request to send control signal	Used only when hardware flow control is enabled
21	UART_CTS	I	UART clear to send control signal	Used only when hardware flow control is enabled
22	UART_TXD	O	UART data output	Also used by the bootloader
23	UART_RXD	I	UART data input	Also used by the bootloader
24	IO_24	I/O	uX IO pin	Can be used for manual digital I/O
25	IO_25	I/O	uX IO pin	Can be used for manual digital I/O
26	GND	-	Ground	
27	IO_27	I/O	uX IO pin	Can be used for manual digital I/O
28	NFC1	I/O	NFC pin 1	
29	NFC2	I/O	NFC pin 2	
30	GND	-	Ground	
31	RSVD	-	RESERVED pin	Leave unconnected
32	IO_32	I/O	uX IO pin	Can be used for manual digital I/O
33	IO_33	I/O	uX IO pin	Can be used for manual digital I/O
34	IO_34	I/O	uX IO pin	Can be used for manual digital I/O
35	IO_35	I/O	uX IO pin	Can be used for manual digital I/O
36	IO_36	I/O	uX IO pin	Can be used for manual digital I/O
37	IO_37	I/O	uX IO pin	Can be used for manual digital I/O
38	IO_38	I/O	uX IO pin	Can be used for manual digital I/O

No.	Name	I/O	Description	Remarks
39	IO_39	I/O	uX IO pin	Can be used for manual digital I/O
40	IO_40	I/O	uX IO pin	Can be used for manual digital I/O
41	IO_41	I/O	uX IO pin	Can be used for manual digital I/O
42	IO_42	I/O	uX IO pin	Can be used for manual digital I/O
43	IO_43	I/O	uX IO pin	Can be used for manual digital I/O
44	IO_44	I/O	uX IO pin	Can be used for manual digital I/O
45	IO_45	I/O	uX IO pin	Can be used for manual digital I/O
46	IO_46	I/O	uX IO pin	Can be used for manual digital I/O
47	IO_47	I/O	uX IO pin	Can be used for manual digital I/O
48	IO_48	I/O	uX IO pin	Can be used for manual digital I/O
49	IO_49	I/O	uX IO pin	Can be used for manual digital I/O
50	IO_50	I/O	uX IO pin	Can be used for manual digital I/O
51	IO_51	I/O	uX IO pin	Can be used for manual digital I/O
52	IO_52	I/O	uX IO pin	Can be used for manual digital I/O
53	GND	-	Ground	
54	RSVD	-	RESERVED pin	Leave unconnected
55	RSVD	-	RESERVED pin	Leave unconnected
	EGP	-	Exposed Ground Pins	The exposed pins in the center of the module should be connected to GND
	EAGP	-	Exposed Antenna Ground Pins	Only on NINA-B316. The exposed pins underneath the antenna area should be connected to GND

Table 9: NINA-B31 series with u-connectXpress software pinout

4 Electrical specifications

Stressing the device above one or more of the [Absolute maximum ratings](#) can cause permanent damage. These are stress ratings only. Operating the module at these or at any conditions other than those specified in the [Operating conditions](#) should be avoided. Exposure to absolute maximum rating conditions for extended periods can affect device reliability.

Where application information is given, it is advisory only and does not form part of the specification.

4.1 Absolute maximum ratings

Symbol	Description	Condition	Min	Max	Unit
VCC	Module supply voltage	Input DC voltage at VCC pin	-0.3	3.9	V
V_DIO	Digital pin voltage	Input DC voltage at any digital I/O pin, VCC ≤ 3.6 V	-0.3	VCC + 0.3	V
		Input DC voltage at any digital I/O pin, VCC > 3.6 V	-0.3	3.9	V
P_ANT	Maximum power at receiver	Input RF power at antenna pin		+10	dBm

Table 10: Absolute maximum ratings

The product is not protected against overvoltage or reversed voltages. Voltage spikes exceeding the power supply voltage specification described in [Table 10](#) must be limited to values within the specified boundaries using the appropriate protection devices.

4.1.1 Maximum ESD ratings

Parameter	Max	Unit	Remarks
ESD sensitivity for all pins except ANT , SWDCLK and SWDIO	2	kV	Human body model according to JS-001
	450	V	Charged device model according to JS-002
ESD indirect contact discharge	±8*	kV	According to EN 301 489-1

* = Tested on EVK-NINA-B3 evaluation board.

Table 11: Maximum ESD ratings

NINA-B3 series modules are Electrostatic Sensitive Devices and require special precautions while handling. See also [ESD precautions](#).

4.2 Operating conditions

Unless otherwise specified, all operating condition specifications are at an ambient temperature of 25 °C and a supply voltage of 3.3 V.

Operation beyond the specified operating conditions is not recommended and extended exposure beyond them may affect device reliability.

4.2.1 Operating temperature range

Parameter	Min	Max	Unit
Storage temperature	-40	+85	°C
Operating temperature	-40	+85	°C

Table 12: Temperature range

4.2.2 Supply/Power pins

Symbol	Parameter	Min	Typ	Max	Unit
VCC	Input supply voltage	1.7	3.3	3.6	V
t_RVCC	Supply voltage rise time			60	ms
VCC_IO	I/O reference voltage		VCC		V

Table 13: Input characteristics of voltage supply pins

4.2.3 Current consumption

Table 14 shows the typical current consumption of a NINA-B3 module – independent of the software that is used.

Mode	Condition	Typical	Peak
Sleep	No clocks running, no RAM data retention	400 nA	
Sleep	No clocks running, 64 kB RAM data retention	880 nA	
Sleep	No clocks running, 256 kB RAM data retention	2.3 µA	
Standby	RTC and 64 kB RAM data retention. System running on 32.768 kHz clock from crystal.	1.3 µA	
Active	CPU running benchmarking tests @ 64 MHz clock speed, all interfaces idle	3.6 mA	
Active	Radio RX only	4.8 mA	
Active	Radio TX only, 0 dBm output power	4.9 mA	
Active	Radio TX only, +8 dBm output power	14.1 mA	
Active	CPU running benchmarking tests @ 64 MHz clock speed, Radio TX 0 dBm output power	9.1 mA	

Table 14: Module VCC current consumption

Table 15 shows some typical use cases using the u-connectXpress software and the corresponding current consumption:

Mode	Condition	3.3 V VCC		1.8 V VCC		
		Average	Peak	Average	Peak	
Active	Advertising (u-blox Serial Service, Apple iBeacon, etc.) at 1 s intervals with +8 dBm output power and 31 bytes payload, CPU and UART interface is running	1 Mbit/s PHY	0.93 mA	20 mA	1.0 mA	37 mA
		CODED PHY	1.0 mA	20 mA	1.3 mA	37 mA
Standby	Advertising (u-blox Serial Service, Apple iBeacon etc.) at 1 s intervals with +8 dBm output power and 31 bytes payload	1 Mbit/s PHY	50 µA	19 mA	65 µA	36 mA
		CODED PHY	150 µA	19 mA	230 µA	36 mA
Active	Connected as peripheral, 50 ms connection interval, +8 dBm output power, no data throughput, CPU and UART interface is running	1 Mbit/s PHY	0.98 mA	20 mA	1.2 mA	37 mA
		2 Mbit/s PHY	0.95 mA	20 mA	1.2 mA	37 mA
		CODED PHY	1.2 mA	20 mA	1.6 mA	37 mA
Standby	Connected as peripheral, 50 ms connection interval, +8 dBm output power, no data throughput	1 Mbit/s PHY	110 µA	19 mA	150 µA	36 mA
		2 Mbit/s PHY	99 µA	19 mA	130 µA	36 mA

Mode	Condition	3.3 V VCC		1.8 V VCC	
		Average	Peak	Average	Peak
Sleep	UART DSR pin is used to enter the sleep mode. No RAM retention.	400 nA	4 mA	400 nA	4 mA

Table 15: Current consumption during typical use cases

The standby mode advertising and connected use cases described in Table 15 list the average current consumption of a NINA-B3 module when using the typical configuration of a 1 s Bluetooth Low Energy advertising interval and a 50 ms Bluetooth Low Energy connection interval. The graphs in Figure 6 and Figure 7 are based on NINA-B3 measurement data and have been calculated to show the average current consumption when different advertising or connection intervals have been configured. They also show a comparison of different output power configurations.

- ⚠ Make sure that the configured output power of your product does not exceed the maximum allowed limits of your intended target market(s). See also the “Regulatory information and requirements” described in the NINA-B3 series system integration manual [3].

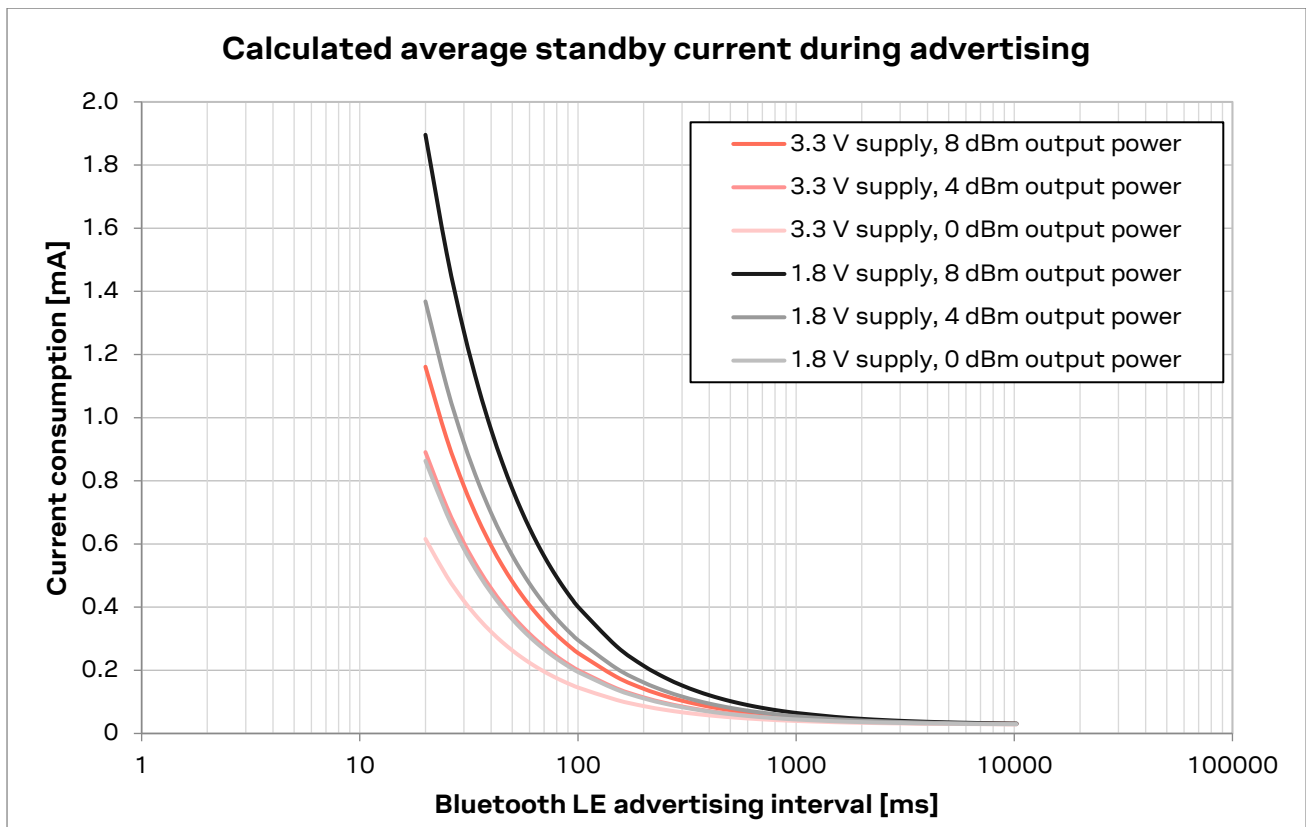
Figure 6: The average standby current for various module configurations and advertising intervals, 1 Mbit/s PHY is used

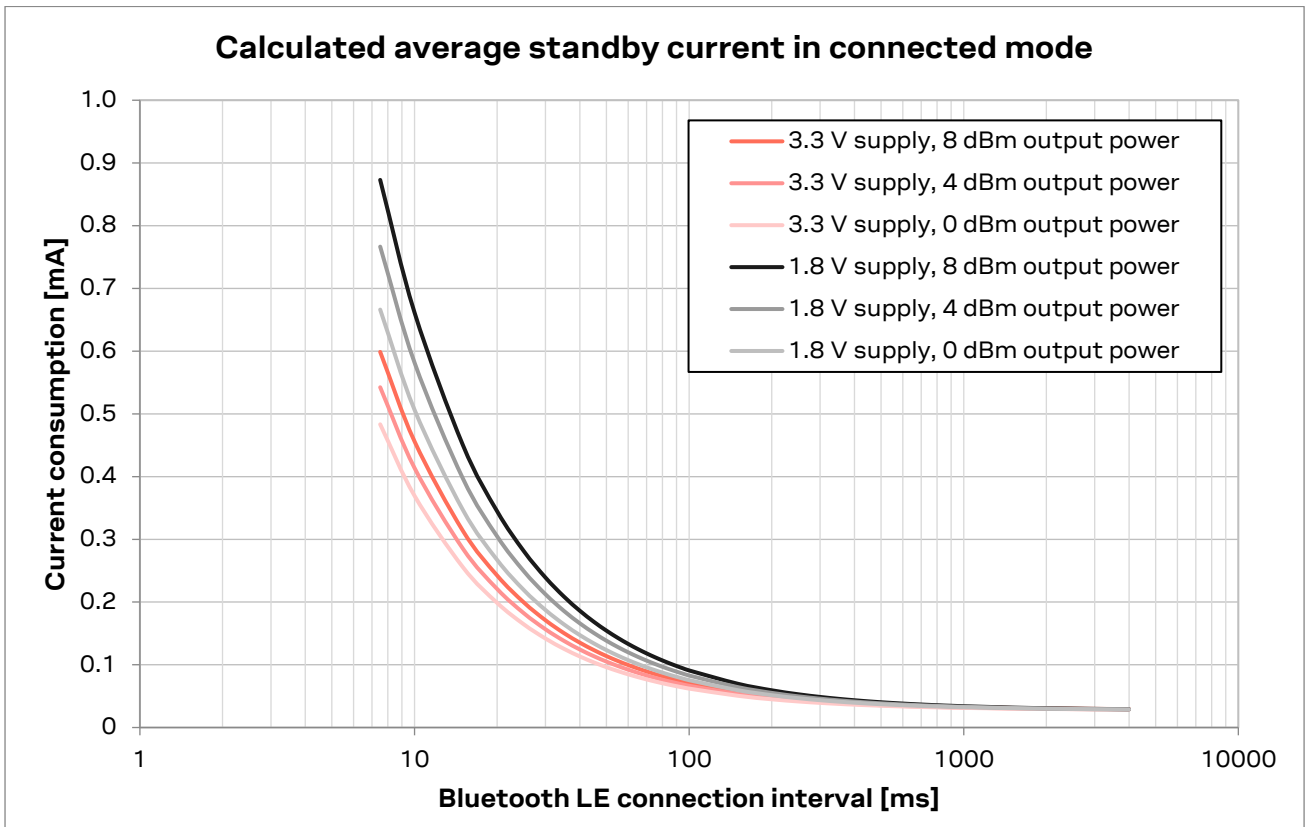

Figure 7: The average standby current for various module configurations and connection intervals with 1 Mbit/s PHY and no data sent over the link

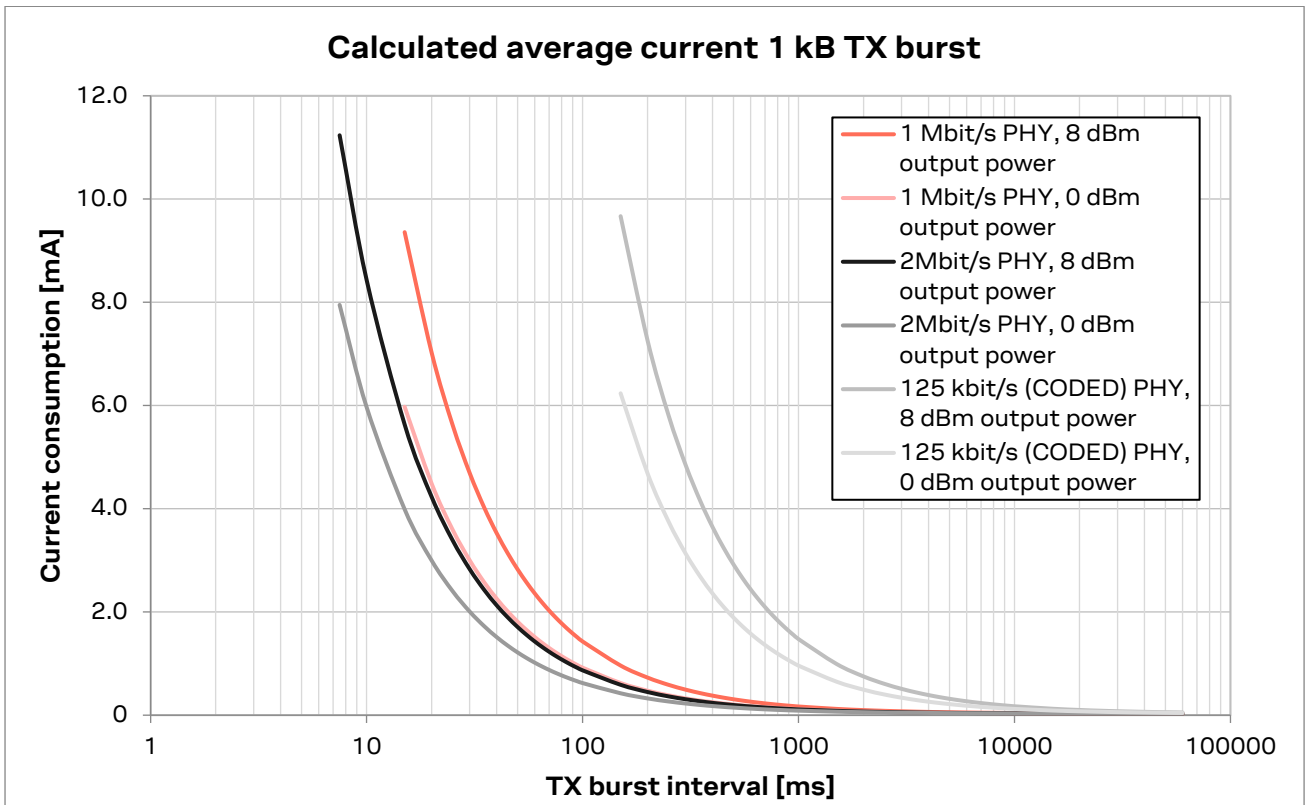

Figure 8: Average standby and TX current for different Bluetooth Low Energy PHY configurations when transmitting a 1 kB data packet at various intervals

The graph in [Figure 8](#) has been calculated to show the current consumption of a NINA-B3 module in connected standby mode, waking up to transmit a 1 kB data packet at various intervals. The test case has been repeated using different Bluetooth Low Energy PHYs and output power configurations.

Mode	Condition	Typical	Peak
Active	USB interface active, current drawn from the VBUS supply	2.4 mA	
Suspended	USB interface suspended, the CPU is sleeping, current drawn from the VBUS supply	262 μ A	

Table 16: USB VBUS current consumption

4.2.4 RF performance

Parameter	Test condition	Min	Typ	Max	Unit
Receiver input sensitivity	Conducted at 25 °C, 1 Mbit/s Bluetooth Low Energy mode		-94		dBm
	Conducted at 25 °C, 2 Mbit/s Bluetooth Low Energy mode		-91		dBm
	Conducted at 25 °C, 500 kbit/s Bluetooth Low Energy mode		-97		dBm
	Conducted at 25 °C, 125 kbit/s Bluetooth Low Energy mode		-100		dBm
Maximum output power	Conducted at 25 °C		+8		dBm
NINA-B3x2 antenna gain	Mounted on an EVB-NINA-B3		+2		dBi
NINA-B3x6 antenna gain	Mounted on an EVB-NINA-B3		+2		dBi

Table 17: RF performance

4.2.5 Throughput characteristics

[Table 18](#) shows some typical values for the throughput, using the supported u-blox SPS service in a room environment at short range. The test is performed with two NINA-B31 modules running u-connectXpress 4.0.0.

Several connected devices will reduce the throughput.

Radio mode	Activity	Power mode	Role	Typical value (kbit/s)	Remarks
Bluetooth LE	Transmitting (Simplex)	ACTIVE	Central->Peripheral	771	PHY 2M, MTU 247, UART 1Mbps, connection interval 7.5 ms
	Transmitting + Receiving (Duplex)	ACTIVE	Central<->Peripheral	555	PHY 2M, MTU 247, UART 1Mbps, connection interval 7.5 ms
				555	

Table 18: Throughput characteristics.

4.2.6 Latency

Latency is measured with two modules connected to the same host and is calculated as the time between when the string is written to the UART on module 1 and is then fully read from the UART of module 2. The string is sent between the modules over SPS.

String length	UART Speed	Connection interval	Latency (ms)		Remarks
			Median	Max	
1	1 Mbps	7.5 ms	6.7	10.4	MTU 247
20	1 Mbps	7.5 ms	7.7	11.2	MTU 247
244	1 Mbps	7.5 ms	16.2	20.7	MTU 247

Table 19: Approximate latency values

Latency measurements are performed using an automatic test system with a low latency host, where the UART driver latency is set to 1 ms.

4.2.7 Antenna radiation patterns

Figure 9 gives an overview of the measurement procedure, and how the NINA-B3 module is aligned to the XYZ-coordinate system. A measurement is taken at every dot in the figure to the left and is represented as a grid point in the radiation pattern to the right.

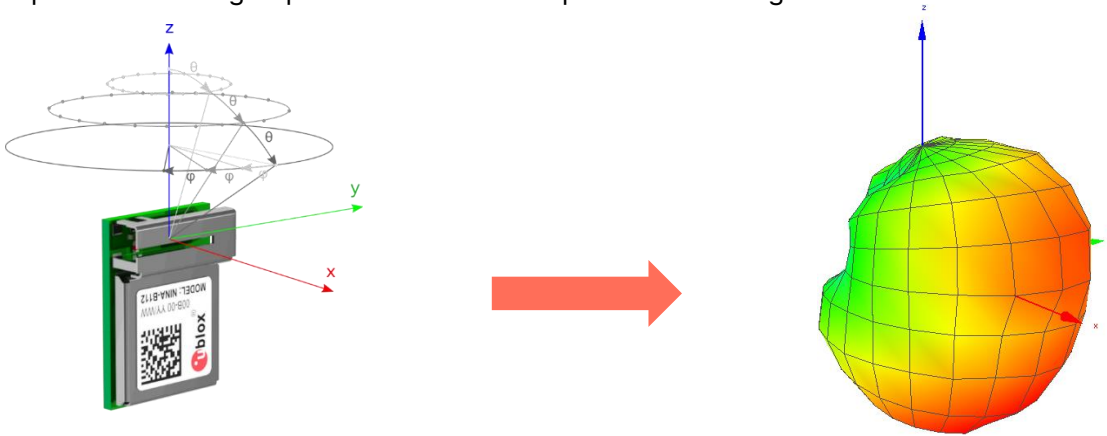
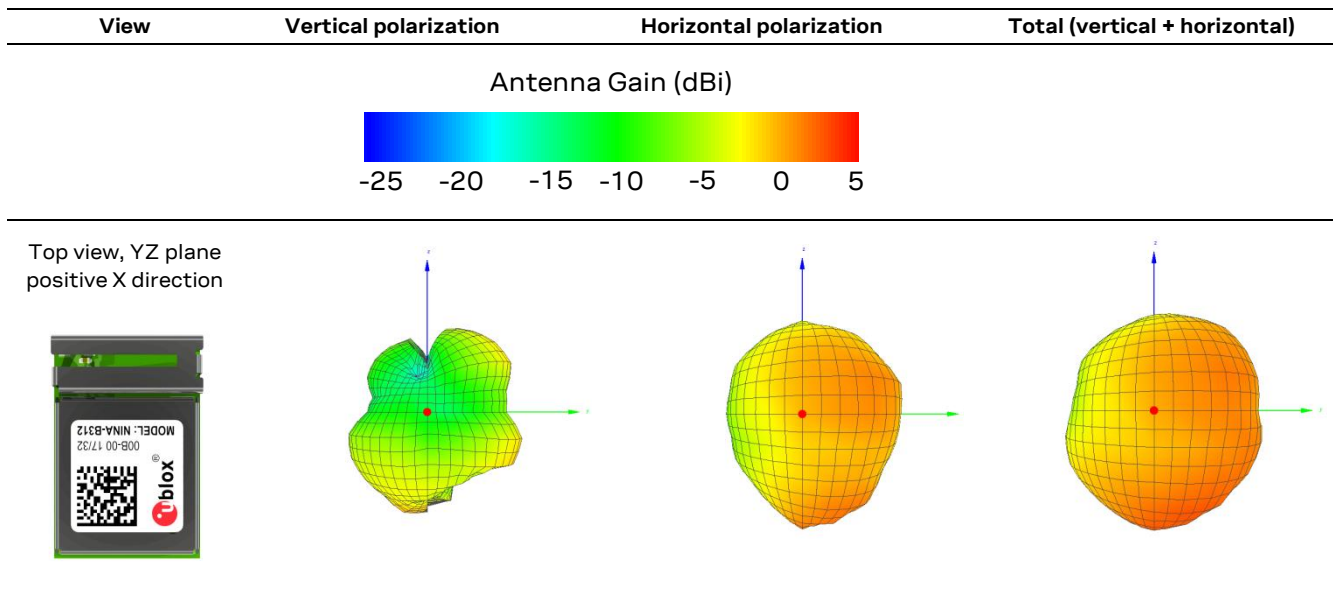
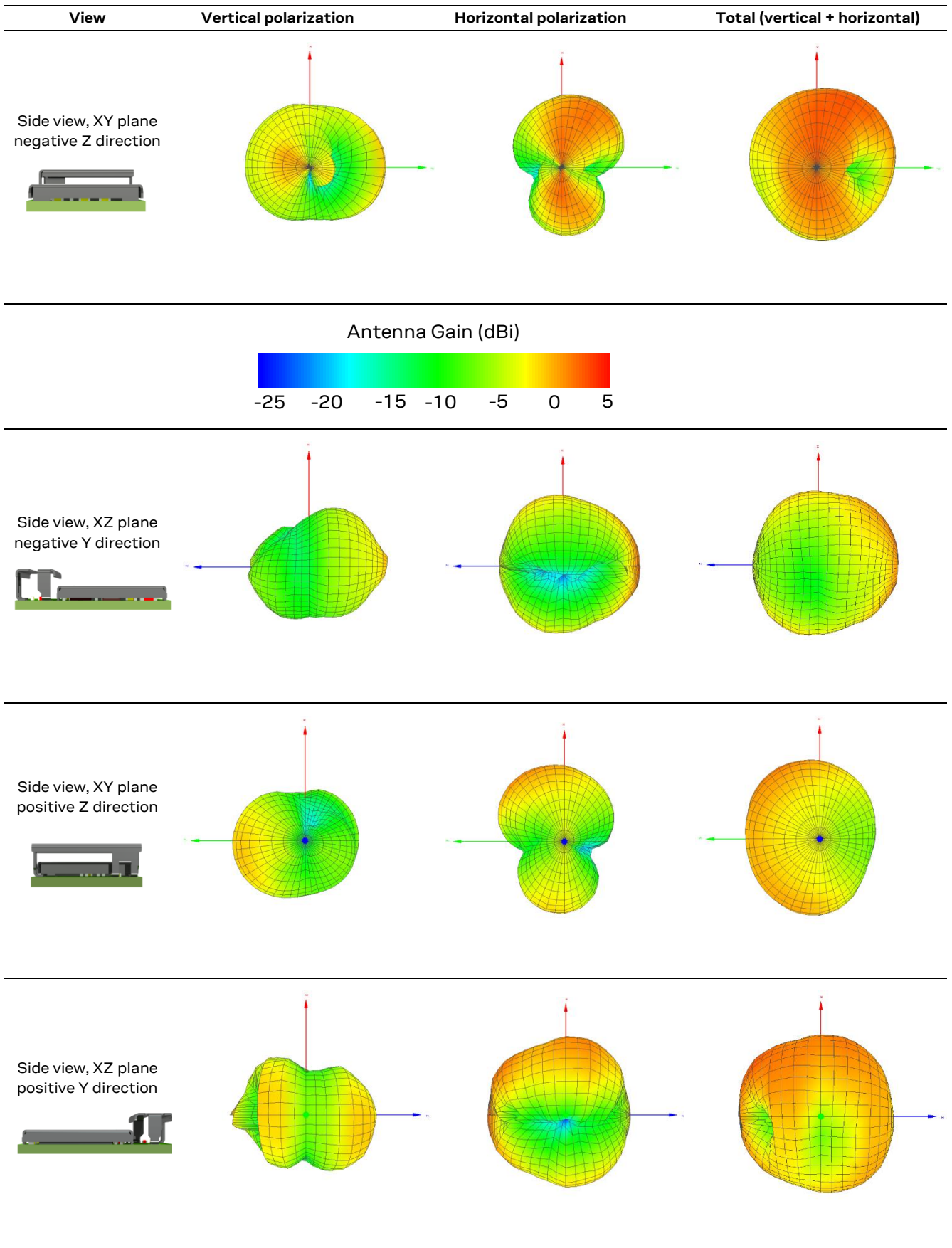

Figure 9: Measurement procedure for determining radiation patterns

The radiation patterns displayed in Table 20 and Table 21 show the antenna gain of the NINA-B3 variants with internal antenna.





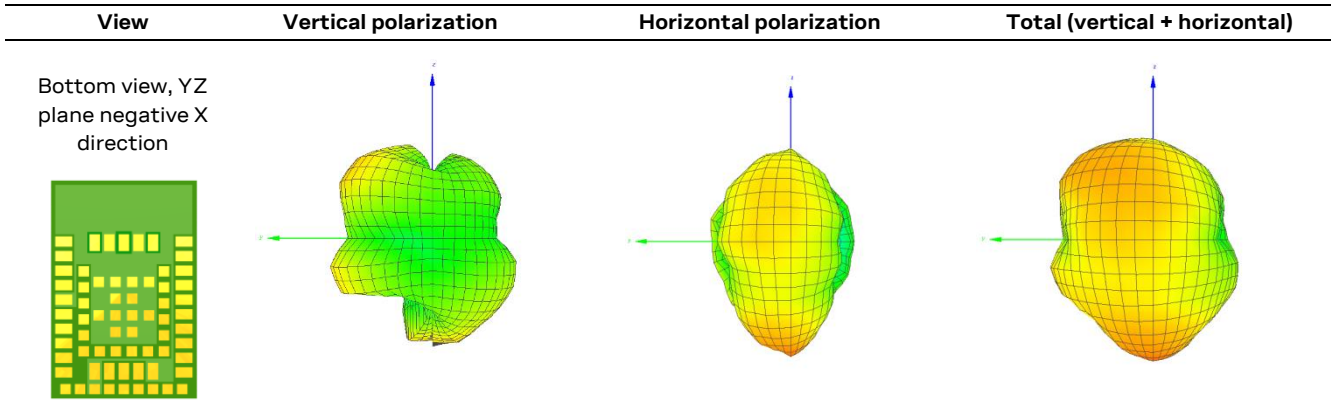
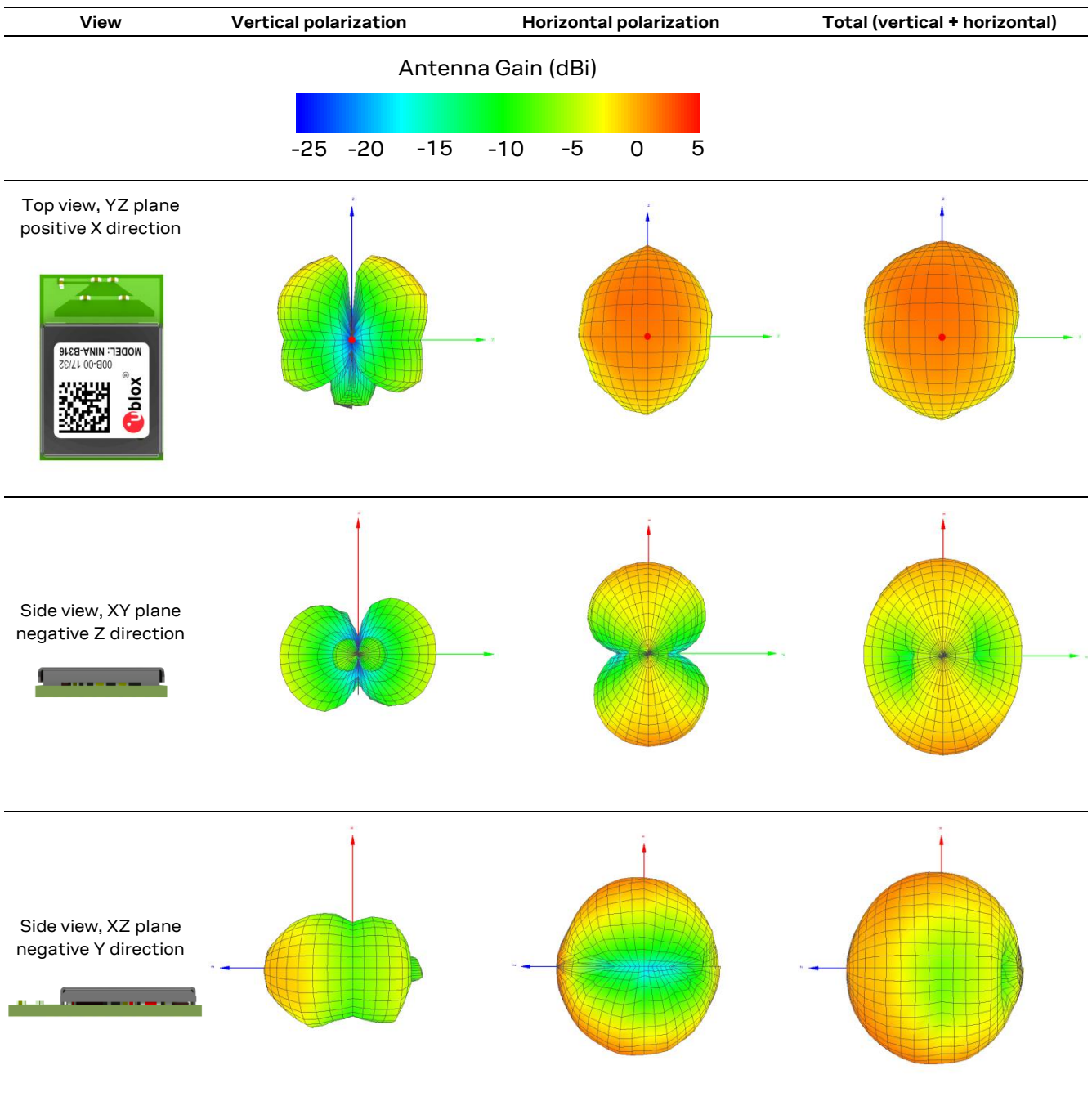

Table 20: NINA-B3x2 antenna radiation patterns



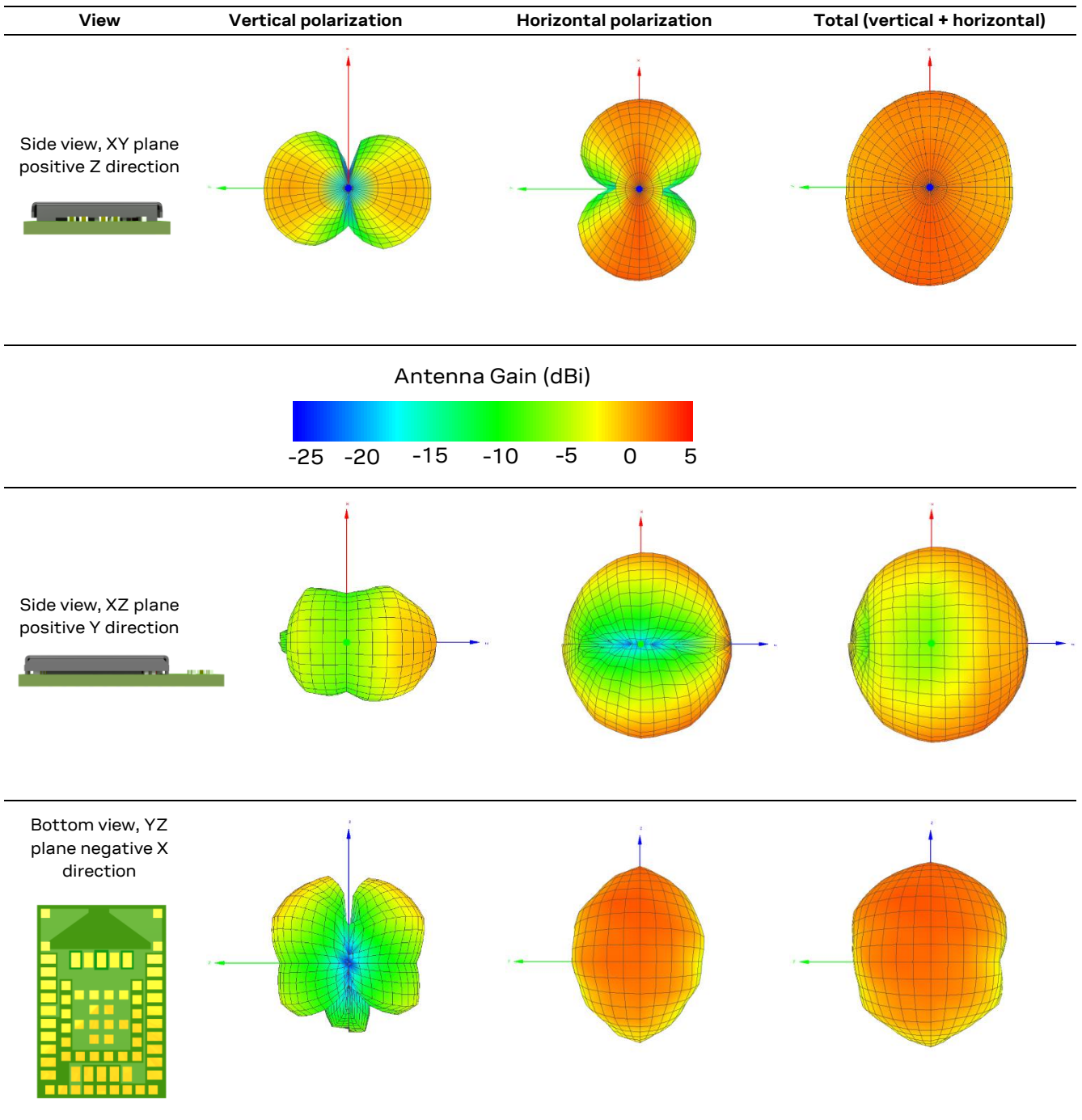

Table 21: NINA-B3x6 antenna radiation patterns

4.2.8 Low frequency crystal

NINA-B3 includes a low power, low frequency crystal clock source that, among other things, drives the Real-Time Counter (RTC).

Use the plot in [Figure 10](#) to determine the frequency error (offset).

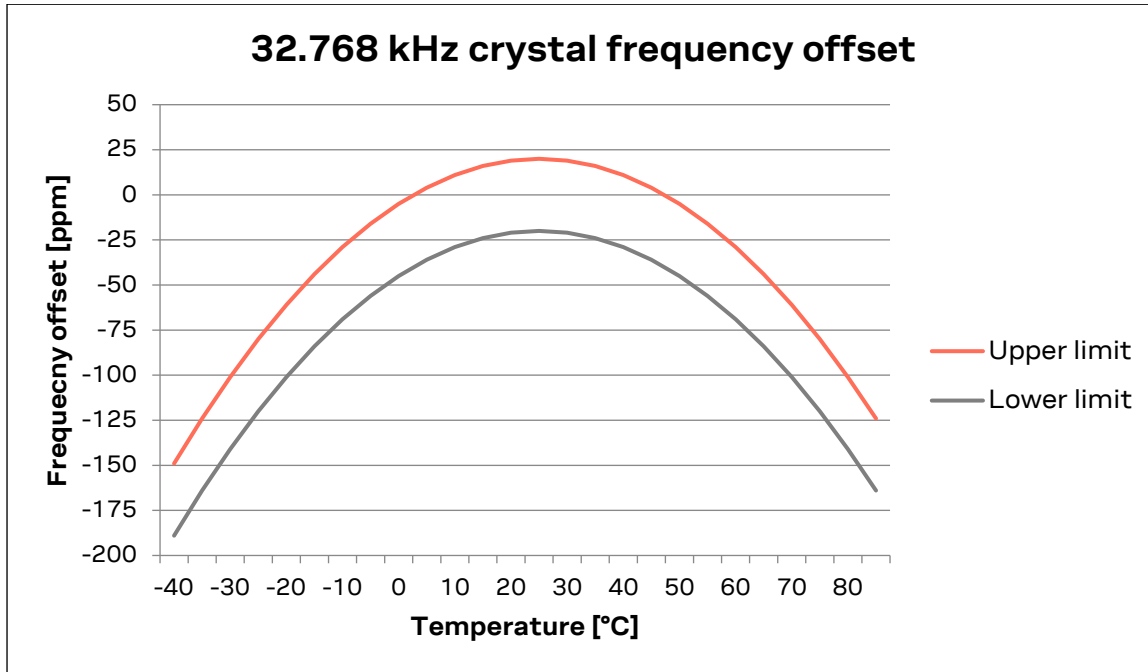

Figure 10: Plot of the temperature-dependent frequency offset for the low frequency crystal clock source

- As crystal sources age and degrade with time some additional drift in their offset frequency is expected. Normally, the factors causing this degradation to stabilize and have lesser effect on the device over time. The NINA-B3 low frequency crystal typically ages no more than +/- 3 ppm over the first year after production.
- The 32.768 kHz low frequency crystal is not included in the NINA-B306-01B variant. This variant can only use the RC oscillator built into the nRF52840 chip. This oscillator has a specified frequency offset of +/- 500 ppm. See also the [nRF52840 data sheet](#).

4.2.9 RESET_N pin

Pin name	Parameter	Min	Typ	Max	Unit	Remarks
RESET_N	Low-level input	0		0.3*VCC	V	
	Internal pull-up resistance		13		kΩ	
	RESET duration			55	ms	Time taken to release a pin reset.

Table 22: RESET_N pin characteristics

4.2.10 Digital pins

Pin name	Parameter	Min	Typ	Max	Unit	Remarks
Any digital pin	Input characteristic: Low-level input	0		0.3*VCC	V	
	Input characteristic: high-level input	0.7*VCC		VCC	V	
	Output characteristic: Low-level output	0		0.4	V	Standard drive strength
		0		0.4	V	High drive strength

Pin name	Parameter	Min	Typ	Max	Unit	Remarks
	Output characteristic: High-level output	VCC-0.4		VCC	V	Standard drive strength
		VCC-0.4		VCC	V	High drive strength
	Sink/Source current	1	2	4	mA	Standard drive strength
		3			mA	High drive strength, VCC < 2.7 V
		6	9	14	mA	High drive strength, VCC ≥ 2.7 V
	Rise/Fall time	9 – 25			ns	Standard drive strength, depending on load capacitance
		4 – 8			ns	High drive strength, depending on load capacitance
	Input pull-up resistance	13			kΩ	Can be added to any GPIO pin configured as input
	Input pull-down resistance	13			kΩ	Can be added to any GPIO pin configured as input
GPIO_28, GPIO_29	Leakage current	1	4		μA	When not configured for NFC and driven to different logic levels

Table 23: Digital pin characteristics

4.2.11 I2C pull-up resistor values

Symbol	Parameter	Bus capacitance	Min	Typ	Max	Unit
R_PUstandard	External pull-up resistance required on I2C interface in standard mode (100 Kbps)	10 pF	1	-	115	kΩ
		50 pF	1	-	23	kΩ
		200 pF	1	-	6	kΩ
		400 pF	1	-	3	kΩ
R_PUfast	External pull-up resistance required on I2C interface in fast mode (400 Kbps)	10 pF	1	-	35	kΩ
		50 pF	1	-	7	kΩ
		200 pF	1	-	1.5	kΩ
		400 pF	1	-	1	kΩ

Table 24: Suggested pull-up resistor values

4.2.12 Analog comparator

Symbol	Parameter	Min	Typ	Max	Unit
I_powersave	Current consumption when the comparator is in 'power save' mode		2		μA
I_balanced	Current consumption when the comparator is in 'balanced' mode		5		μA
I_speed	Current consumption when the comparator is in 'high speed' mode		10		μA
I_lowpower	Current consumption of the low power comparator		0.5		μA
t_powersave	Time to generate interrupt/event when the comparator is in 'power save' mode		0.6		μs
t_balanced	Time to generate interrupt/event when the comparator is in 'balanced' mode		0.2		μs
t_speed	Time to generate interrupt/event when the comparator is in 'high speed' mode		0.1		μs
t_lowpower	Time to generate interrupt/event for the low power comparator		5		μs

Table 25: Electrical specification of the two analog comparators

5 Mechanical specifications

5.1 NINA-B3x1 mechanical specification

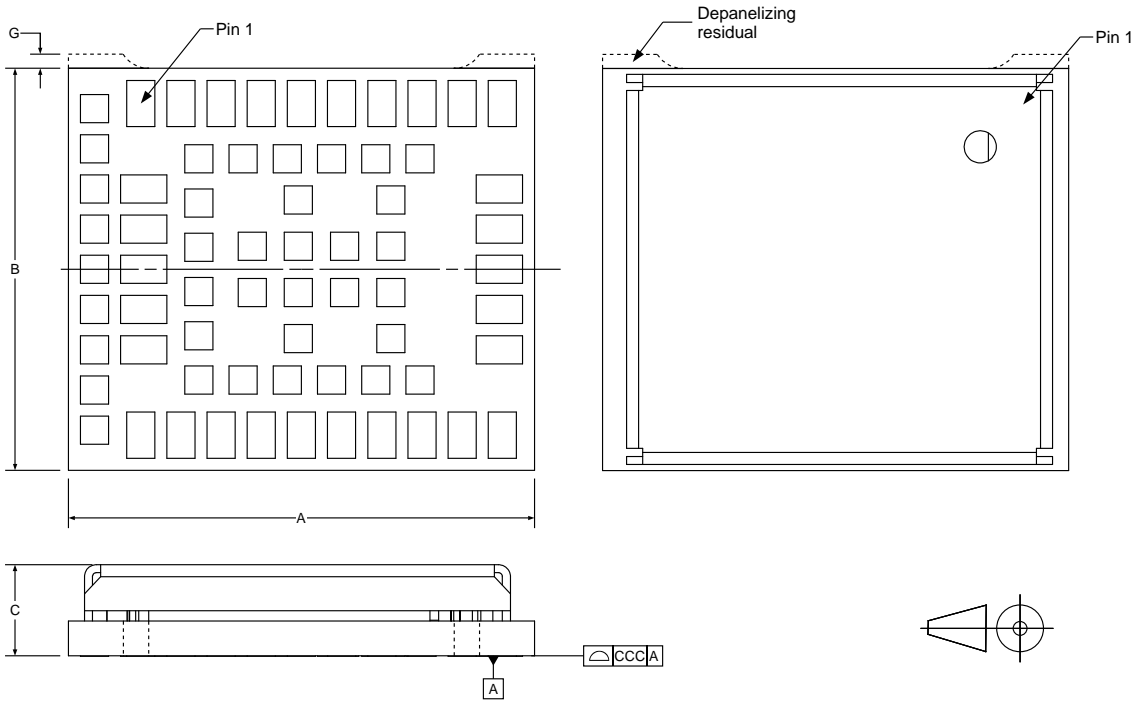

Figure 11: NINA-B3x1 mechanical outline

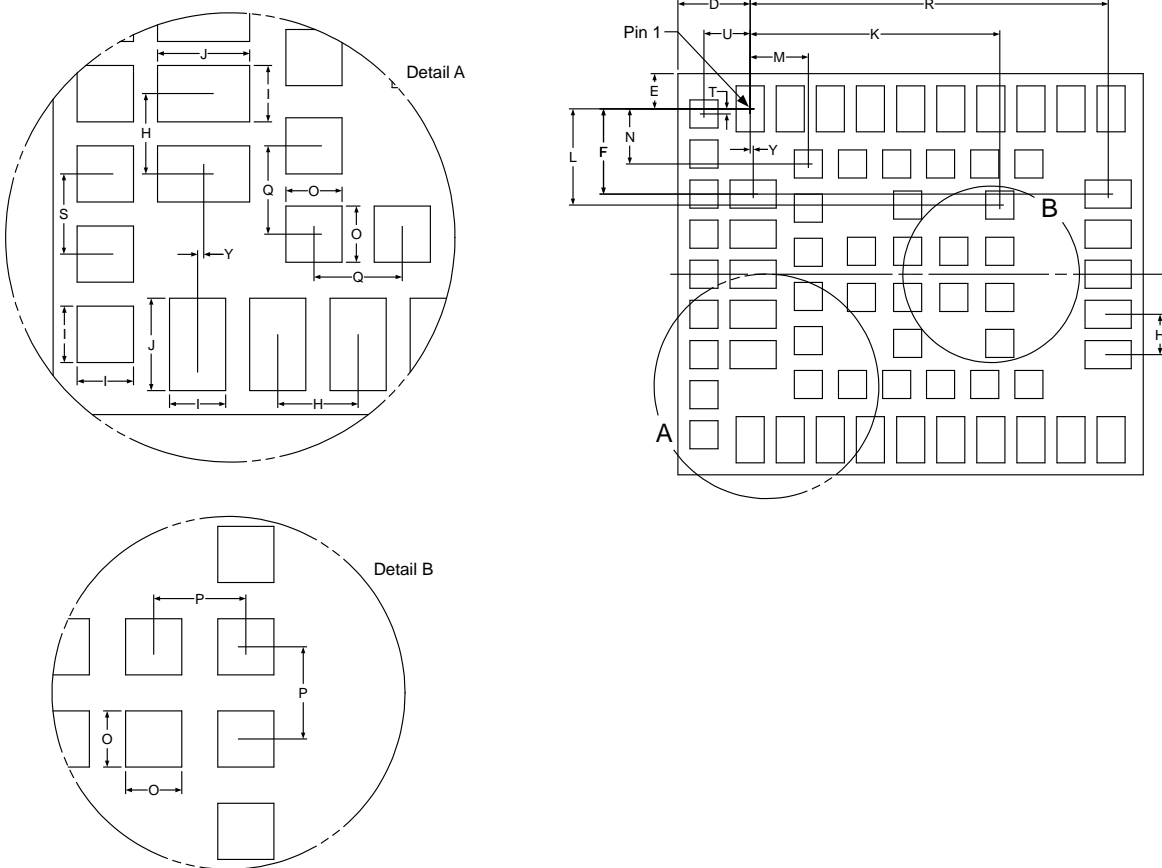

Figure 12: NINA-B3 detailed dimensions

Parameter	Description	Typical [mm]	[mil]	Tolerance [mm]	[mil]
A	Module PCB length	11.6	456.7	+0.20/-0.10	+7.9/-3.9
B	Module PCB width	10.0	393.7	+0.20/-0.10	+7.9/-3.9
C	Module thickness	2.23	87.8	+0.40/-0.20	+15.8/-7.9
ccc	Seating plane coplanarity	0.10	3.9	+0.02/-0.10	+0.8/-3.9
D	Horizontal edge to pin no. 1 center	1.80	70.9	+/-0.10	+/-3.9
E	Vertical edge to pin no. 1 center	0.875	34.4	+/-0.10	+/-3.9
F	Vertical pin no. 1 center to lateral pin center	2.125	83.7	+/-0.05	+/-2.0
G	Depanelizing residual	0.10	3.9	+0.25/-0.1	+9.8/-3.9
H	Lateral and antenna row pin to pin pitch	1.00	39.4	+/-0.05	+/-2.0
I	Lateral, antenna row and outer pin width	0.70	27.6	+/-0.05	+/-2.0
J	Lateral and antenna row pin length	1.15	45.3	+/-0.05	+/-2.0
K	Horizontal pin no. 1 center to central pin center	6.225	245.1	+/-0.05	+/-2.0
L	Vertical pin no. 1 center to central pin center	2.40	94.5	+/-0.05	+/-2.0
M	Horizontal pin no. 1 center to inner row pin center	1.45	57.1	+/-0.05	+/-2.0
N	Vertical pin no. 1 center to inner row pin center	1.375	54.1	+/-0.05	+/-2.0
O	Central, inner and outer row pin width and length	0.70	27.6	+/-0.05	+/-2.0
P	Central pin to central pin pitch	1.15	45.3	+/-0.05	+/-2.0
Q	Inner row pin to pin pitch	1.10	43.3	+/-0.05	+/-2.0
R	Horizontal pin no. 1 center to antenna row pin center	8.925	351.4	+/-0.05	+/-2.0
S	Outer row pin to pin pitch	1.00	39.4	+/-0.05	+/-2.0
T	Vertical pin no. 1 center to outer row pin center	0.125	4.9	+/-0.05	+/-2.0
U	Horizontal pin no. 1 center to outer row pin center	1.15	45.3	+/-0.05	+/-2.0
Y	Horizontal pin no. 1 center to lateral pin center	0.075	3.0	+/-0.05	+/-2.0
	Module weight [g]	<1.0			

Table 26: NINA-B3x1 mechanical outline data

5.2 NINA-B3x2 mechanical specification

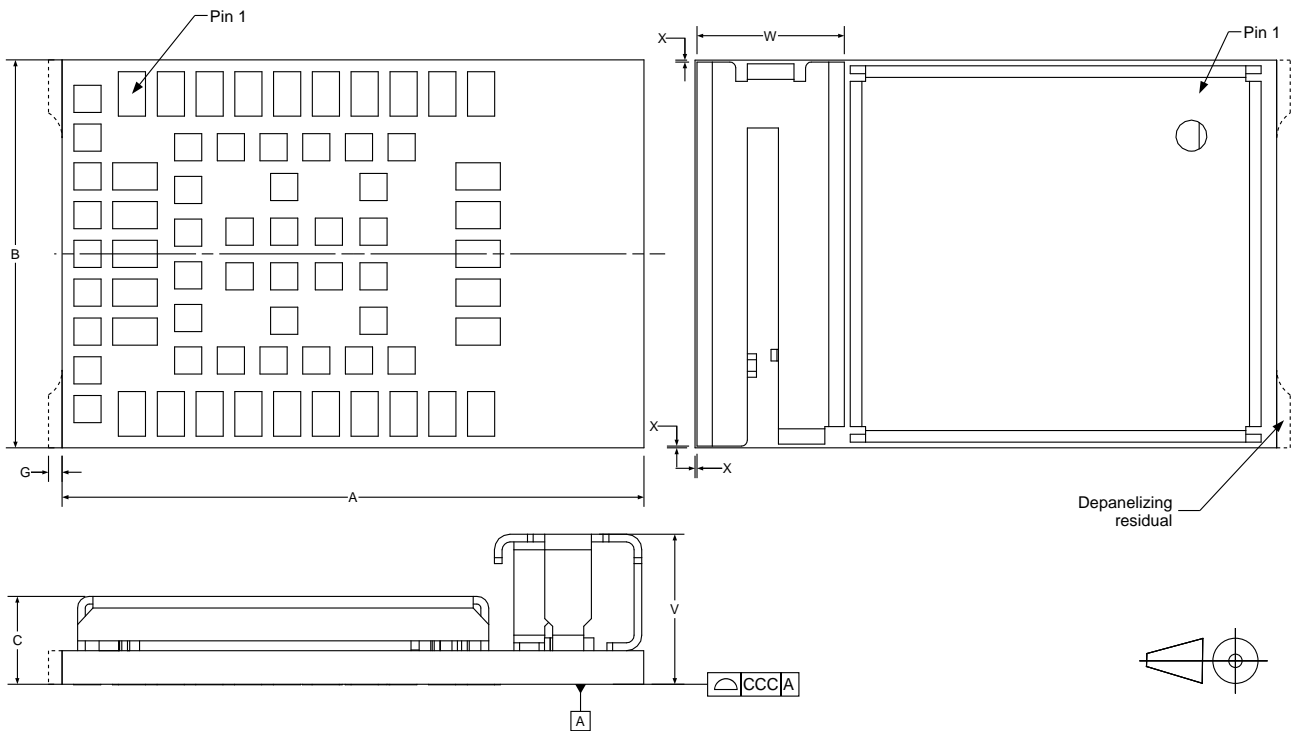

Figure 13: NINA-B3x2 mechanical outline

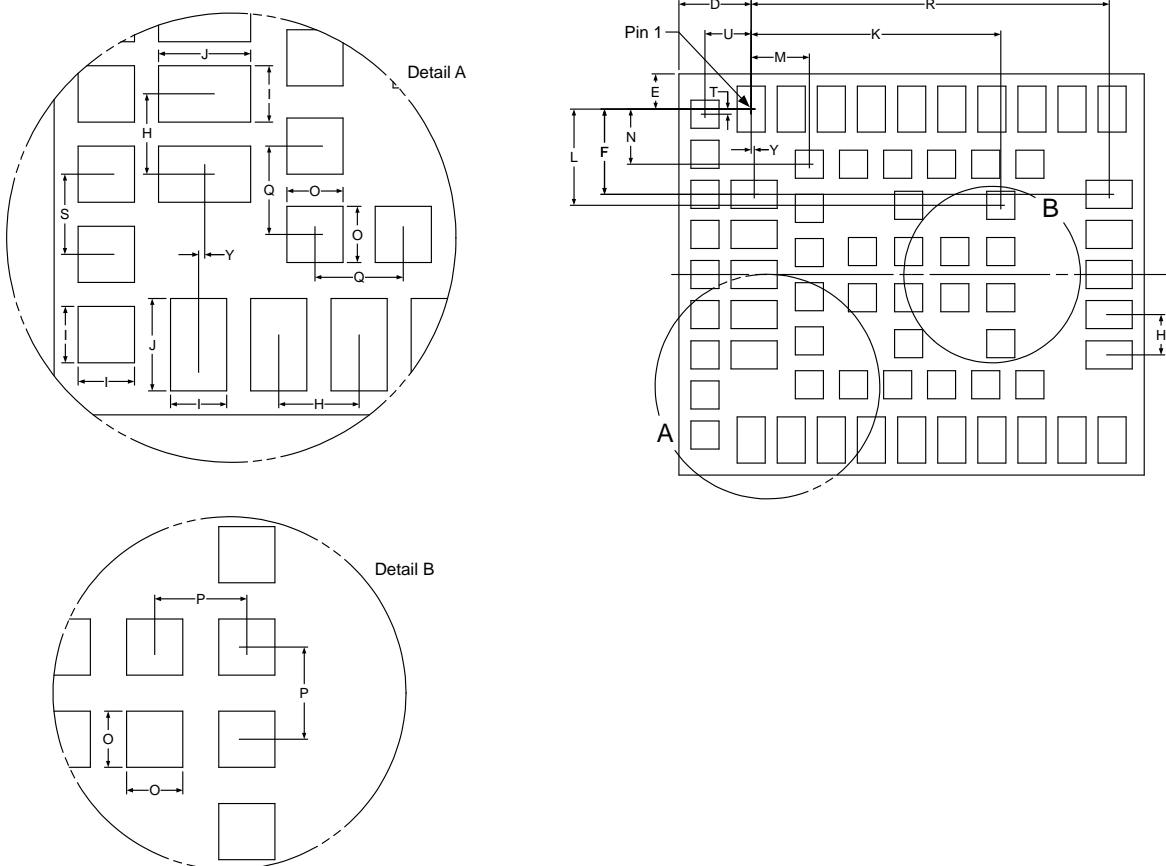

Figure 14: NINA-B3 detailed dimensions

Parameter	Description	Typical [mm]	[mil]	Tolerance [mm]	[mil]
A	Module PCB length	15.0	590.6	+0.20/-0.10	+7.9/-3.9
B	Module PCB width	10.0	393.7	+0.20/-0.10	+7.9/-3.9
C	Module thickness	2.23	87.8	+0.40/-0.20	+15.8/-7.9
ccc	Seating plane coplanarity	0.10	3.9	+0.02/-0.10	+0.8/-3.9
D	Horizontal edge to pin no. 1 center	1.80	70.9	+/-0.10	+/-3.9
E	Vertical edge to pin no. 1 center	0.875	34.4	+/-0.10	+/-3.9
F	Vertical pin no. 1 center to lateral pin center	2.125	83.7	+/-0.05	+/-2.0
G	Depanelizing residual	0.10	3.9	+0.25/-0.1	+9.8/-3.9
H	Lateral and antenna row pin to pin pitch	1.00	39.4	+/-0.05	+/-2.0
I	Lateral, antenna row and outer pin width	0.70	27.6	+/-0.05	+/-2.0
J	Lateral and antenna row pin length	1.15	45.3	+/-0.05	+/-2.0
K	Horizontal pin no. 1 center to central pin center	6.225	245.1	+/-0.05	+/-2.0
L	Vertical pin no. 1 center to central pin center	2.40	94.5	+/-0.05	+/-2.0
M	Horizontal pin no. 1 center to inner row pin center	1.45	57.1	+/-0.05	+/-2.0
N	Vertical pin no. 1 center to inner row pin center	1.375	54.1	+/-0.05	+/-2.0
O	Central, inner and outer row pin width and length	0.70	27.6	+/-0.05	+/-2.0
P	Central pin to central pin pitch	1.15	45.3	+/-0.05	+/-2.0
Q	Inner row pin to pin pitch	1.10	43.3	+/-0.05	+/-2.0
R	Horizontal pin no. 1 center to antenna row pin center	8.925	351.4	+/-0.05	+/-2.0
S	Outer row pin to pin pitch	1.00	39.4	+/-0.05	+/-2.0
T	Vertical pin no. 1 center to outer row pin center	0.125	4.9	+/-0.05	+/-2.0
U	Horizontal pin no. 1 center to outer row pin center	1.15	45.3	+/-0.05	+/-2.0
V	PCB and antenna thickness	3.83	150.8	+0.40/-0.20	+15.8/-7.9
W	Module antenna width	3.8	149.6	+/-0.20	+/-7.9
X	Antenna overhang outside module outline on any side	0.0	0.0	+0.60	+23.6
Y	Horizontal pin no. 1 center to lateral pin center	0.075	3.0	+/-0.05	+/-2.0
	Module weight [g]	<1.0			

Table 27: NINA-B3x2 mechanical outline data

5.3 NINA-B3x6 mechanical specification

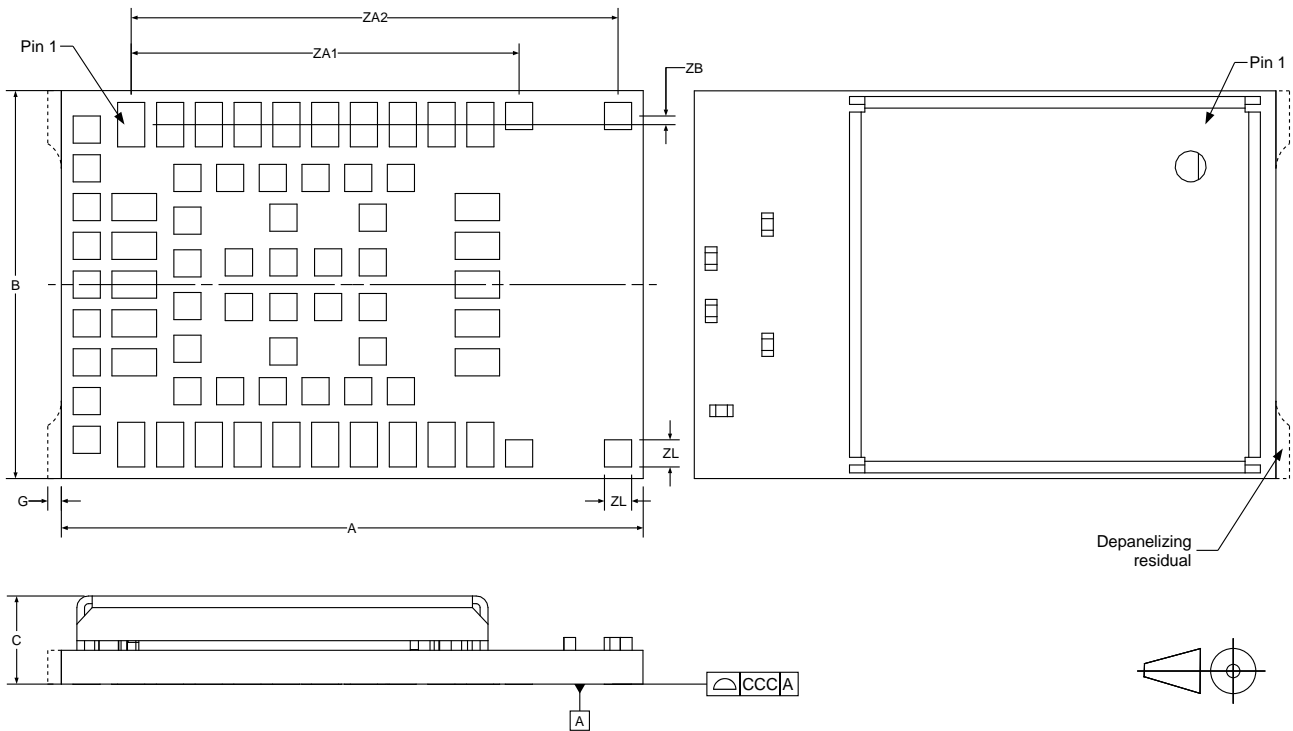

Figure 15: NINA-B3x6 mechanical outline

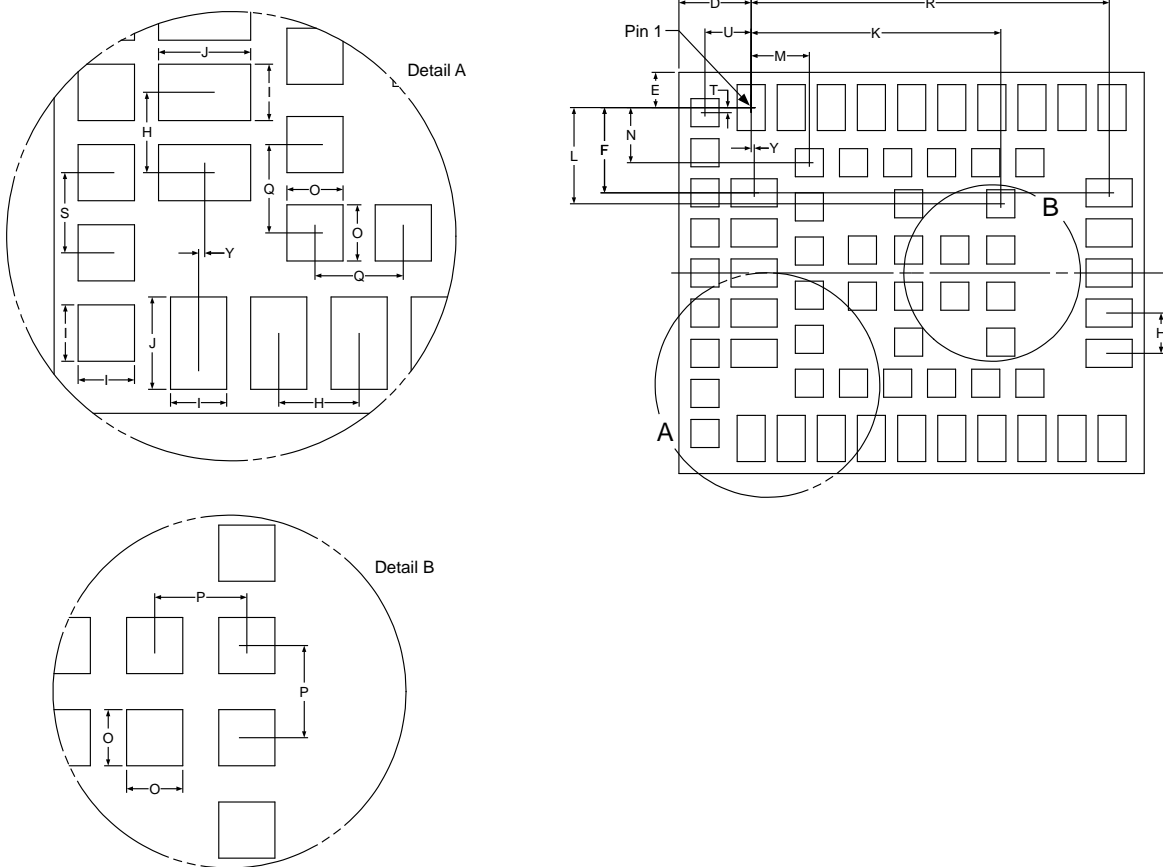

Figure 16: NINA-B3 detailed dimensions

Parameter	Description	Typical [mm]	[mil]	Tolerance [mm]	[mil]
A	Module PCB length	15.0	590.6	+0.20/-0.10	+7.9/-3.9
B	Module PCB width	10.0	393.7	+0.20/-0.10	+7.9/-3.9
C	Module thickness	2.23	87.8	+0.40/-0.20	+15.8/-7.9
ccc	Seating plane coplanarity	0.10	3.9	+0.02/-0.10	+0.8/-3.9
D	Horizontal edge to pin no. 1 center	1.80	70.9	+/-0.10	+/-3.9
E	Vertical edge to pin no. 1 center	0.875	34.4	+/-0.10	+/-3.9
F	Vertical pin no. 1 center to lateral pin center	2.125	83.7	+/-0.05	+/-2.0
G	Depanelizing residual	0.10	3.9	+0.25/-0.1	+9.8/-3.9
H	Lateral and antenna row pin to pin pitch	1.00	39.4	+/-0.05	+/-2.0
I	Lateral, antenna row and outer pin width	0.70	27.6	+/-0.05	+/-2.0
J	Lateral and antenna row pin length	1.15	45.3	+/-0.05	+/-2.0
K	Horizontal pin no. 1 center to central pin center	6.225	245.1	+/-0.05	+/-2.0
L	Vertical pin no. 1 center to central pin center	2.40	94.5	+/-0.05	+/-2.0
M	Horizontal pin no. 1 center to inner row pin center	1.45	57.1	+/-0.05	+/-2.0
N	Vertical pin no. 1 center to inner row pin center	1.375	54.1	+/-0.05	+/-2.0
O	Central, inner and outer row pin width and length	0.70	27.6	+/-0.05	+/-2.0
P	Central pin to central pin pitch	1.15	45.3	+/-0.05	+/-2.0
Q	Inner row pin to pin pitch	1.10	43.3	+/-0.05	+/-2.0
R	Horizontal pin no. 1 center to antenna row pin center	8.925	351.4	+/-0.05	+/-2.0
S	Outer row pin to pin pitch	1.00	39.4	+/-0.05	+/-2.0
T	Vertical pin no. 1 center to outer row pin center	0.125	4.9	+/-0.05	+/-2.0
U	Horizontal pin no. 1 center to outer row pin center	1.15	45.3	+/-0.05	+/-2.0
Y	Horizontal pin no. 1 center to lateral pin center	0.075	3.0	+/-0.05	+/-2.0
ZA1	Horizontal pin no. 1 center to first set of antenna GND pins pin center	10.0	393.7	+/-0.05	+/-2.0
ZA2	Horizontal pin no. 1 center to second set of antenna GND pins pin center	12.55	494.1	+/-0.05	+/-2.0
ZB	Vertical pin no.1 center to antenna GND pin center	0.225	8.9	+/-0.05	+/-2.0
ZL	Antenna GND pin width and length	0.70	27.6	+/-0.05	+/-2.0
	Module weight [g]	<1.0			

Table 28: NINA-B3x6 mechanical outline data

6 Qualification and approvals

6.1 Compliance with the RoHS directive

NINA-B3 series modules comply with the Directive 2011/65/EU (EU RoHS 2) and its amendment Directive (EU) 2015/863 (EU RoHS 3).

6.2 Country approvals

The NINA-B3 modules are certified for use in the following countries/regions:

Country/region	NINA-B3x1	NINA-B3x2	NINA-B3x6
Europe	Approved	Approved	Approved
Great Britain (UKCA)	Approved	Approved	Approved
USA	Approved	Approved	Approved
Canada	Approved	Approved	Approved
Japan	Approved	Approved	Approved
Taiwan	Approved	Approved	Approved
South Korea	Approved	Approved	Approved
Brazil	Approved	Approved	Approved
Australia	Approved	Approved	Approved
New Zealand	Approved	Approved	Approved
South Africa	Approved	Approved	Approved

See the NINA-B3 series system integration manual [3] for detailed information about the regulatory requirements that must be met when using NINA-B3 modules in an end product.

6.3 Bluetooth qualification



The NINA-B3 module series has been qualified as an end product according to the Bluetooth 5.0 specification.

Product type	QD ID	Listing date
End product	118016	14-Sep-2018

Table 29: NINA-B3 series Bluetooth qualified design ID

7 Product handling

7.1 Packaging

NINA-B3 series modules are delivered as hermetically sealed, reeled tapes to enable efficient production, production lot set-up and tear-down. For more information about packaging, see also the Packaging reference guide [1].

7.1.1 Reels

NINA-B3 modules are deliverable in quantities of 500 pieces on a reel. The reel types for each module variant are described in Table 30. For more information about the reel types, see also the Packaging reference guide [1].

Model	Reel type
NINA-B3x1	B1
NINA-B3x2	A3
NINA-B3x6	A3

Table 30: Reel types for different models of the NINA-B3 series

7.1.2 Tapes

Figure 17 shows the position and orientation of the NINA-B3 modules as they are delivered on tape.

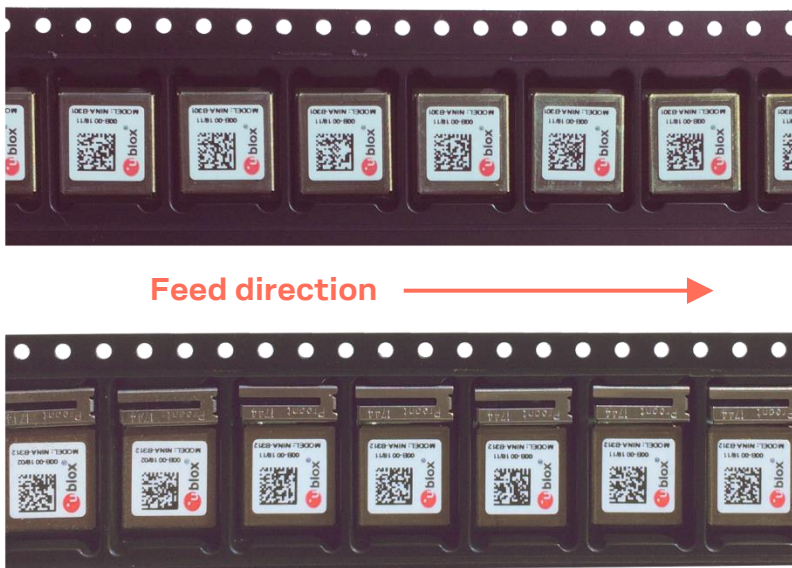
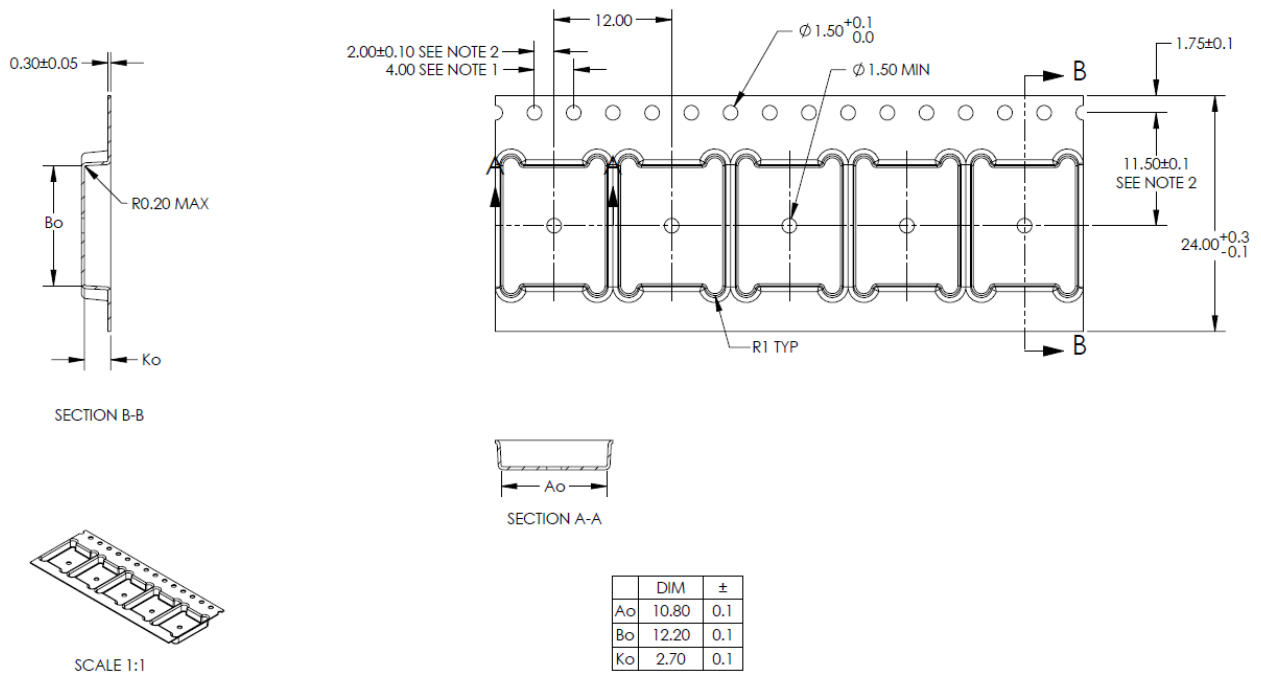

Figure 17: Orientation of NINA-B3 modules on tape

The tape dimensions for NINA-B3x1 modules are shown in [Figure 18](#).



- NOTES:
1. 10 SPROCKET HOLE PITCH CUMULATIVE TOLERANCE ± 0.2
 2. POCKET POSITION RELATIVE TO SPROCKET HOLE MEASURED AS TRUE POSITION OF POCKET, NOT POCKET HOLE.
 3. Ao AND Bo ARE MEASURED ON A PLANE AT A DISTANCE "R" ABOVE THE BOTTOM OF THE POCKET.

Figure 18: NINA-B3x1 tape dimensions

The tape dimensions for NINA-B3x2 are shown in [Figure 19](#).

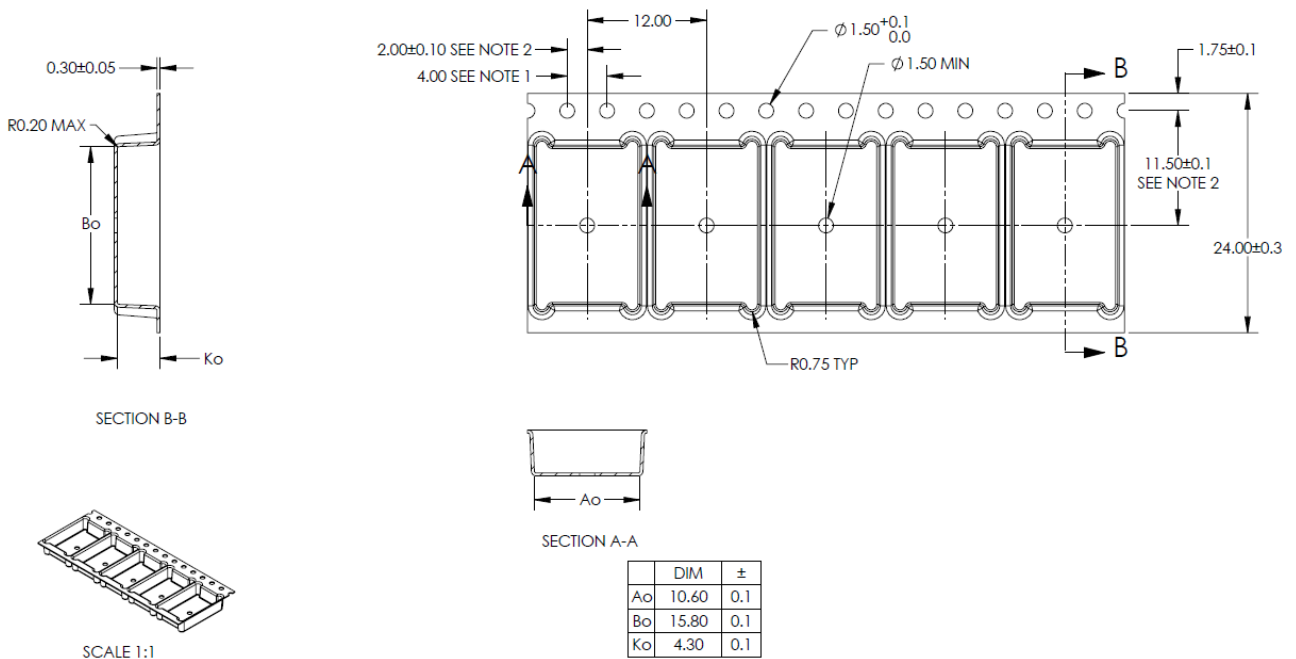

- NOTES:
1. 10 SPROCKET HOLE PITCH CUMULATIVE TOLERANCE ± 0.2
 2. POCKET POSITION RELATIVE TO SPROCKET HOLE MEASURED AS TRUE POSITION OF POCKET, NOT POCKET HOLE.
 3. Ao AND Bo ARE MEASURED ON A PLANE AT A DISTANCE "R" ABOVE THE BOTTOM OF THE POCKET.

Figure 19: NINA-B3x2 and NINA-B3x6 tape dimensions

7.2 Moisture sensitivity levels

-  NINA-B3 series modules are rated as MSL Level 4 devices in accordance with the IPC/JEDEC J-STD-020 standard. For detailed information, see the moisture sensitive warning label on the MBB (Moisture Barrier Bag).

After opening the dry pack, the modules must be mounted within 72 hours in factory conditions of maximum 30 °C/60% RH or must be stored at less than 10% RH. The modules require baking if the humidity indicator card shows more than 10% when read at 23±5 °C or if the conditions mentioned above are not met. For information about the bake procedure, see also the J-STD-033B standard.

For more information regarding MSL (Moisture Sensitivity Level), labeling, and storage, see also the Packaging reference guide [\[1\]](#).

7.3 Reflow soldering

NINA-B3 series modules are approved for one-time reflow processes only.

-  Reflow soldering profiles must be selected in accordance with u-blox soldering recommendations described in the system integration manual [\[3\]](#). Failure to observe these recommendations can result in severe damage to the product.

7.4 ESD precautions

NINA-B3 series modules are Electrostatic Sensitive Devices that demand the observance of special handling precautions against static damage. Failure to observe these precautions can result in severe damage to the product. See also [Maximum ESD ratings](#).

Proper ESD handling and packaging procedures must be applied throughout the processing, handling, and operation of any application that incorporates the NINA-B3 series module. ESD precautions are particularly relevant when handling the application board on which the module is mounted.

For further information about the handling of NINA-B2 series modules, see also the NINA-B2 system integration manual [\[3\]](#).

8 Labeling and ordering information

8.1 Product labeling

The (7.5 x 7.5 mm) labels on the NINA-B3 series modules include important product information.

Figure 23 shows the label applied to NINA-B3 series modules. Each of the given label references are described in Table 31.



Figure 23: Location of product type number on the NINA-B3 series module label

Reference	Description
1	Date of unit production encoded YY/WW (year, week)
2	Major and minor product version information
3	Product model name (NINA-B301, NINA-B302, NINA-B306, NINA-B311, NINA-B312, or NINA-B316)
4	Data Matrix with unique serial number comprising 19 alphanumeric symbols: <ul style="list-style-type: none"> - The first 3 symbols are used for production tracking and are an abbreviated representation of the Type number that is unique to each module variant. - The following 12 symbols represent the unique hexadecimal Bluetooth address of the module AABCCDDEEFF, and The last 4 symbols represent the hardware and firmware version encoded HFFF. See also MAC addresses .
5	u-blox logo. The red dot also indicates pin 1.

Table 31: NINA-B2 series label description

8.1.1 Product identifiers

Table 32 describes the three product identifiers, namely the Type number, Model name and Ordering code.

Format	Description	Nomenclature
Model name	Describes the form factor, platform technology and platform variant. Used mostly in product documentation like this data sheet, the model name represents the most common identity for all u-blox products	PPPP-TGVV
Ordering code	Comprises the model name – with additional identifiers to describe the major product version and quality grade	PPPP-TGVV-TTQ
Type number	Comprises the model name and ordering code – with additional identifiers to describe minor product versions.	PPPP-TGVV-TTQ-XX

Table 32: Product code formats

8.1.2 Identification codes

Table 34 describes the individual identification codes represented in each product identifier.

Code	Meaning	Example
PPPP	Form factor	NINA
TG	Platform (Technology and Generation) T – Dominant technology, For example: W: Wi-Fi, B: Bluetooth G - Generation	B3: Bluetooth Generation 3
VV	Variant based on the same platform; range [00...99]	31: u-connectXpress software product with antenna pin
TT	Major Product Version	00: first revision
Q	Quality grade A: Automotive B: Professional C: Standard	B: professional grade
XX	Minor product version (not relevant for certification)	Default value is 00

Table 33: Part identification code

Table 34 explains the parts of the product code.

Code	Meaning	Example
PPPP	Form factor	NINA
TG	Platform (Technology and Generation) T – Dominant technology, for example, W: Wi-Fi, B: Bluetooth G - Generation	B3: Bluetooth Generation 3
VV	Variant based on the same platform; range [00...99]	11: default configuration, with antenna pin
TT	Major product version	00: first revision
Q	Quality grade A: Automotive B: Professional C: Standard	B: professional grade
XX	Minor product version (not relevant for certification)	Default value is 00

Table 34: Part identification code

8.2 Ordering information

Ordering code	Product
NINA-B301-00B	NINA-B3 module with antenna pin, open CPU for custom applications
NINA-B302-00B	NINA-B3 module with internal PIFA antenna, open CPU for custom applications
NINA-B306-00B	NINA-B3 module with internal PCB antenna, open CPU for custom applications
NINA-B306-01B	NINA-B3 module with internal PCB antenna, open CPU for custom applications. Cost down version without internal 32.768 kHz crystal.
NINA-B311-00B	NINA-B3 module with antenna pin, pre-flashed with software version 1.0.0 and locked for use with u-connectXpress
NINA-B311-01B	NINA-B3 module with antenna pin, pre-flashed with software version 2.0.0 and locked for use with u-connectXpress
NINA-B311-02B	NINA-B3 module with antenna pin, pre-flashed with software version 4.0.0 and locked for use with u-connectXpress
NINA-B312-00B	NINA-B3 module with internal PIFA antenna, pre-flashed with software version 1.0.0 and locked for use with u-connectXpress
NINA-B312-01B	NINA-B3 module with internal PIFA antenna, pre-flashed with software version 2.0.0 and locked for use with u-connectXpress
NINA-B312-02B	NINA-B3 module with internal PIFA antenna, pre-flashed with software version 4.0.0 and locked for use with u-connectXpress
NINA-B316-01B	NINA-B3 module with internal PCB antenna, pre-flashed with software version 2.0.0 and locked for use with u-connectXpress
NINA-B316-02B	NINA-B3 module with internal PCB antenna, pre-flashed with software version 4.0.0 and locked for use with u-connectXpress

Table 35: Product ordering codes

Appendix

A Glossary

Abbreviation	Definition
ADC	Analog to Digital Converter
BLE	Bluetooth Low Energy
BPF	Band Pass Filter
CTS	Clear To Send
EDM	Extended Data mode
ESD	Electro Static Discharge
FCC	Federal Communications Commission
GATT	Generic ATtribute profile
GPIO	General Purpose Input/Output
IC	Industry Canada
I2C	Inter-Integrated Circuit
MCU	Micro Controller Unit
MSD	Moisture Sensitive Device
QSPI	Quad Serial Peripheral Interface
RTS	Request To Send
SPI	Serial Peripheral Interface
TBD	To be Defined
UART	Universal Asynchronous Receiver/Transmitter

Table 36: Explanation of the abbreviations and terms used

Related documents

- [1] Packaging reference guide, [UBX-14001652](#)
- [2] u-connectXpress AT commands manual, [UBX-14044127](#)
- [3] NINA-B3 series system integration manual, [UBX-17056748](#)
- [4] u-connectXpress software user guide, [UBX-16024251](#)

 For product change notifications and regular updates of u-blox documentation, register on our website, www.u-blox.com.

Revision history

Revision	Date	Name	Comments
R01	10-Nov-2017	ajoh, apet	Initial release.
R02	8-Jun-2018	ajoh, kgom	Removed Arm Mbed software option. Updated the mechanical specification (Section 5). Updated RF parameters such as output power and receiver sensitivity (Table 4). Added current consumption data when running the u-blox connectivity software (Table 15).
R03	13-Sep-2018	ajoh, kgom	Changed the product status to Initial Production. Updated Table 2 and Table 3. In Table 27, modified the module PCB length to 15. Included information about Drive strength in GPIO (section 2.7.1) and limitations of the radio sensitive pins in section 3.1. Added some digital pin characteristics in section 4.2.10. Moved certification, qualification and antenna information (previously sections 6 and 7) to the NINA-B3 System Integration Manual.
R04	14-Feb-2019	mape, ajoh	Updated Section 6 with further country approvals. Added NINA-B3x6 as a product. Added u-blox JavaScript software as a software option (-20B).
R05	16-Apr-2019	ajoh	Changed the product status to Initial Production. Added more detailed current consumption data in the Electrical Specifications (Section 4). Added tolerances to the Mechanical Specification (Section 5). Updated country approvals list in the Qualification and approvals section (Section 6.2).
R06	10-May-2019	ajoh	Added antenna radiation patterns for internal antenna variants NINA-B3x2 and NINA-B3x6. Added hardware version numbers and updated the software version to 1.0.1 for u-connectScript variants in the "applicable products" table on page 2.
R07	20-Jan-2020	mwej	Updated Country approvals (section 6.2). Added info about RoHS 3 compliance (section 6.1). Added Tape dimensions (section 7.1.2). Updated ESD HBM and CDM voltages (section 4.1.1). Corrected mil dimensions (parameter A, E and F) in mechanical specification (chapter 5).
R08	24-Mar-2020	ajoh, mape	Updated the ESD rating section (4.1.1) to match actual u-blox qualification ratings. Removed the earlier claim suggesting that the module has an automatic over and under temperature shut-down feature in section 2.3.2. Added section 0 specifying the frequency offset of the low frequency crystal. Removed u-connectScript references and products from document.
R09	13-Jul-2020	ajoh	Split the u-connectXpress UART information into primary and secondary sections. Added information on the u-connectXpress secondary UART (section 2.8.4.2).
R10	22-Dec-2020	ajoh	Added NINA-B306-01B variant.
R11	13-Aug-2021	hisa	Added NINA-B31x-02B variants in Document information and Ordering information . Updated contact information and revised all document cross references.

Revision	Date	Name	Comments
R12	29-May-2023	mape, lalb	Revised storage temperature to 85 °C in Operating temperature range (PCN UBX-23001751). Revised Maximum ESD sensitivity to 450 V in Maximum ESD ratings (PCN UBX-23001751). Added UKCA regulatory approval in Country approvals . Added Throughput characteristics and Latency chapters. Corrected the number of PWM channels from 12 to 4x four channel in Pulse Width Modulation (PWM) . Removed ambiguous description of operating condition ranges in Electrical specifications . Removed obsolete Antennas section – now maintained in the system integration manual. Clarified that only a subset of the interfaces is available with u-connectXpress in Block diagram and Interfaces . Clarified that IEEE 802.15.4 and proprietary radio modes are not available with u-connectXpress in Product description . Improved information describing Moisture sensitivity levels , Reflow soldering , and ESD precautions . Revised contact information.

Contact

u-blox AG

Address: Zürcherstrasse 68
8800 Thalwil
Switzerland

For further support and contact information, visit us at www.u-blox.com/support.