

REV.	DESCRIPTION	DESIGN	APPROVAL	DATE
A0	初始版本			

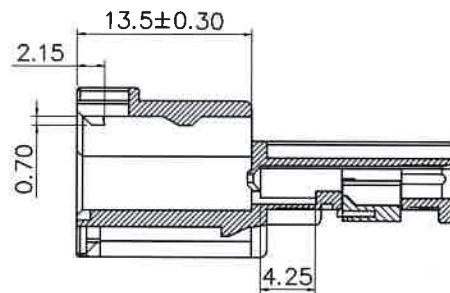
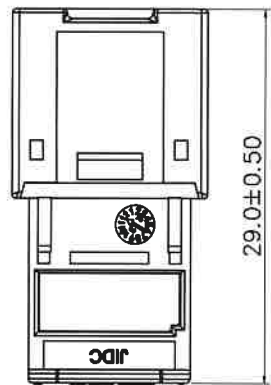

NOTES:

- Material/材质
Housing/主体: PBT UL94V-0,
Color/颜色: Black/黑色
- The surface of the product shall be free of excessive plastic, lack of plastic, mottle, etc
产品表面不能有多胶、缺胶、杂色等现象
- Harmful material please follow RoHS
产品需符合RoHS标准
- 编码原则: 951- 04 1 X -089
Color:
1: WHITE 2: BLACK
4: RED 9: BLUE

A-A

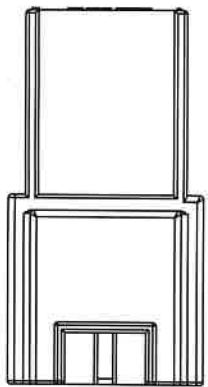
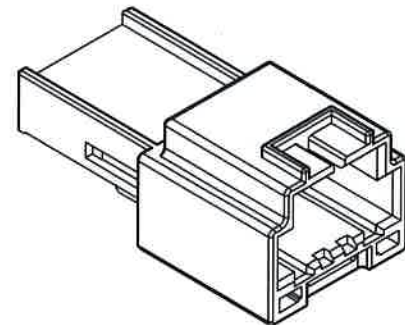
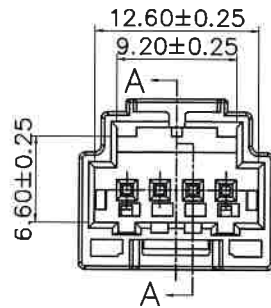
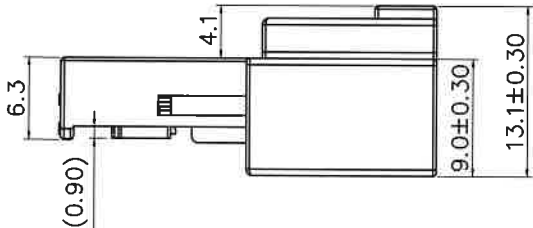
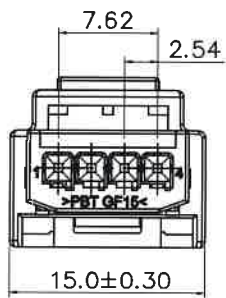

广东济德精密电子有限公司
 受控文件
 日期: 2021年10月20日

X.± 0.35	X.*± 1*
.X± 0.25	.X*± 0.5*
.XX± 0.15	.XX*± /
.XXX± 0.05	.XXX*± /
UNITS:	mm



Guangdong JiDe Precision Electronics Co., Ltd
 广东济德精密电子有限公司

The information in this document is property of JIDC company and should not be copied or reproduced in any other way, without written permission.

TITLE:
2.54 PITCH MALE HOUSING

PART NO.
951-0412-089

APPD: *Jerry*
 CHKD: *Ray*
 DRAW: *Colinyl*

DWG NO:
C-951-0412-089

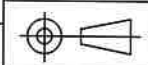

SCALE	SHEET	REV.
1:1	1/1	A0