



**Features**

- Input Voltage Range: 36 V to 75 V
- Programmable Output Voltage
- +90 % Efficiency
- 1500 VDC Isolation
- On/Off Control
- Over-Current Protection
- Differential Remote Sense
- Output Over-Voltage Protection
- Over-Temperature Shutdown
- Undervoltage Lockout
- Low Profile Package (12mm)
- Compact Footprint Comparable to ¼-Brick: (Horiz Config. 1.45 in × 2.6 in, Vertical Config. < 1 in<sup>2</sup>)
- Surface Mountable
- Agency Approvals: UL 60950, CSA 22.2 950
- IPC Lead Free 2

**Description**

The PT4410 series of power modules are single-output isolated DC/DC converters, housed in a compact 21-pin low-profile (12 mm) package. These modules are rated up to 100W with load currents as high as 30 A. The output voltage is set within a pre-defined range via a 5-bit input code.

The PT4410 series operates from a standard 48-V telecom CO supply and occupies only 3.9 in<sup>2</sup> of PCB area. These modules offer OEMs a compact and flexible high-output power source for use with high-end microprocessors, DSPs, general purpose logic and analog. They are suitable for distributed power applications in both telecom and computing environments.

Features include output over-current protection, on/off control, output over-voltage protection (OVP), over-temperature shutdown, under-voltage lockout (UVLO), and an output differential remote sense. The modules are fully integrated for stand-alone operation, and require no additional components. The horizontal package outline is also comparable to industry standard ¼-bricks, allowing for a dual PWB layout.

**Ordering Information**

- PT4411□ = 1.3 to 3.5 Volts
- PT4412□ = 1.05 to 1.75 Volts
- PT4413□ = 3.4 to 5.7 Volts

**PT Series Suffix (PT1234 x)**

Case/Pin Configuration	Order Suffix	Package Code
Vertical	<b>N</b>	(ENM)
Horizontal	<b>A</b>	(ENN)
SMD	<b>C</b>	(ENP)

*(Reference the applicable package code drawing for the dimensions and PC layout)*

**Pin-Out Information**

Pin	Function
1	Remote On/Off *
2	-V <sub>in</sub>
3	-V <sub>in</sub>
4	+V <sub>in</sub>
5	+V <sub>in</sub>
6	Pin Not Present
7	VID 0
8	VID 1
9	VID 2
10	VID 3
11	VID 4 †
12	(-)Remote Sense
13	-V <sub>o</sub>
14	-V <sub>o</sub>
15	-V <sub>o</sub>
16	-V <sub>o</sub>
17	+V <sub>o</sub>
18	+V <sub>o</sub>
19	+V <sub>o</sub>
20	+V <sub>o</sub>
21	(+)Remote Sense

\* For more information consult the applicable application note.  
† VID 4 does not function on the PT4412 & PT4413

**Standard Application**

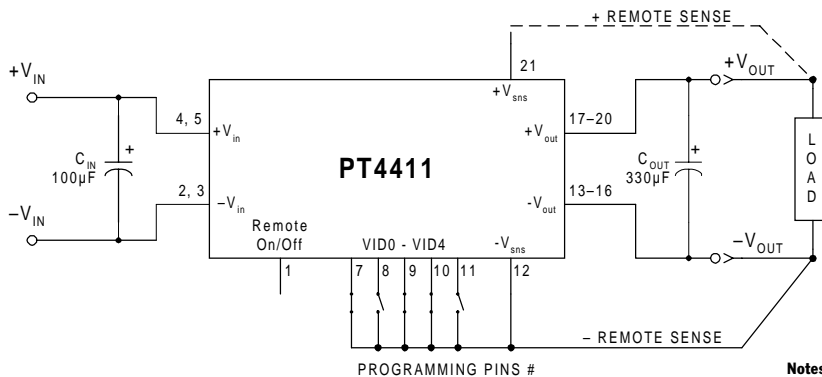

**Notes:**  
C<sub>IN</sub> = Optional 100 µF electrolytic capacitor  
C<sub>OUT</sub> = Optional 330 µF electrolytic capacitor  
# VID programming pins are set for 3.3 V output

## Environmental Specifications

Characteristics	Symbols	Conditions	Min	Typ	Max	Units
Operating Temperature Range	T <sub>a</sub>	Over V <sub>in</sub> Range	-40	—	+85 (i)	°C
Shutdown Temperature	OTP	Case temperature - auto reset	—	115	—	°C
Solder Reflow Temperature	T <sub>reflow</sub>	Surface temperature of module pins or case	—	—	215 (ii)	°C
Storage Temperature	T <sub>s</sub>	—	-40	—	+125	°C
Mechanical Shock		Per Mil-STD-883D, Method 2002.3 1 msec, ½ Sine, mounted	—	500	—	G's
Mechanical Vibration		Mil-STD-883D, Method 2007.2 20-2000 Hz, PCB mounted	—	15 (iii) 20 (iii)	—	G's
Weight	—	Vertical/Horizontal	—	50	—	grams
Flammability	—	Meets UL 94V-O	—	—	—	—

**Notes** (i) See SOA curves or consult factory for appropriate derating

(ii) During solder reflow of SMD package version, do not elevate the module case, pins, or internal component temperatures above a peak of 215 °C. For further guidance refer to the application note, "Reflow Soldering Requirements for Plug-in Power Surface Mount Products," (SLTA051).

(iii) The case pins on the through-hole package types (suffixes N & A) must be soldered. For more information see the applicable package outline drawing.

## Output Voltage Programming Information

				PT4411		PT4412	PT4413
VID3	VID2	VID1	VID0	VID4=1 Vout	VID4=0 Vout	VID4= NC Vout	VID4= NC Vout
1	1	1	1	N/D *	1.30 V	N/D *	N/D *
1	1	1	0	2.10 V	1.35 V	1.05 V	3.40 V
1	1	0	1	2.20 V	1.40 V	1.10 V	3.56 V
1	1	0	0	2.30 V	1.45 V	1.15 V	3.72 V
1	0	1	1	2.40 V	1.50 V	1.20 V	3.88 V
1	0	1	0	2.50 V	1.55 V	1.25 V	4.05 V
1	0	0	1	2.60 V	1.60 V	1.30 V	4.21 V
1	0	0	0	2.70 V	1.65 V	1.35 V	4.37 V
0	1	1	1	2.80 V	1.70 V	1.40 V	4.53 V
0	1	1	0	2.90 V	1.75 V	1.45 V	4.69 V
0	1	0	1	3.00 V	1.80 V	1.50 V	4.86 V
0	1	0	0	3.10 V	1.85 V	1.55 V	5.02 V
0	0	1	1	3.20 V	1.90 V	1.60 V	5.18 V
0	0	1	0	3.30 V	1.95 V	1.65 V	5.34 V
0	0	0	1	3.40 V	2.00 V	1.70 V	5.50 V
0	0	0	0	3.50 V	2.05 V	1.75 V	5.67 V

Logic 0 =Pin 12 potential; (-)Remote Sense  
Logic 1 =Open circuit (no pull-up resistors)

\* N/D = Voltage is not defined. The regulator produces a low-voltage periodic pulse (less than 1 V) approximately every 10 ms.

**Note:** During operation, changes to the program code should be limited to 15 % of V<sub>o</sub> so as to avoid activating the output O V protection.

## Pin Descriptions

**+Vin:** The positive input for the module with respect to -V<sub>in</sub>. When powering the module from a -48-V telecom central office supply, this input is connected to the primary system ground.

**-Vin:** The negative input supply for the module, and the 0 VDC reference for the Remote On/Off input. When powering the module from a +48-V supply, this input is connected to the 48-V(Return).

**Remote On/Off:** An open-collector (open-drain) positive logic input that is referenced to -V<sub>in</sub>. Pulling this input down to -V<sub>in</sub> potential disables the module's output. If this input is left open-circuit, the module will produce an output whenever a valid input source is applied.

**VID0 - VID4:** Selects the set-point output voltage of the converter according to the applicable program code. VID0 - VID4 must either be connected to (-)Remote Sense or left open circuit. *Note:* For the PT4412, VID 4 is internally disabled and may be left open circuit.

**+Vo:** The positive power output with respect to -V<sub>o</sub>, which is DC isolated from the input supply pins. If a negative output voltage is desired, +V<sub>o</sub> should be connected to the secondary circuit common and the output taken from -V<sub>o</sub>.

**-Vo:** The negative power output with respect to +V<sub>o</sub>, which is DC isolated from the input supply pins. This output is normally connected to the secondary circuit common when a positive output voltage is desired.

**+Remote Sense:** Provides the converter with remote sense capability to regulate the set-point voltage directly at the load. When used with -Remote Sense, the regulation circuitry will compensate for voltage drop between the converter and the load. The pin may be left open circuit, but connecting it to +V<sub>o</sub> will improve load regulation.

**-Remote Sense:** This is the logic '0' reference for the inputs VID0 - VID4, and provides the converter with remote sense capability when used in conjunction with +Remote Sense. For optimum output voltage accuracy this pin should always be connected to -V<sub>o</sub>.

**PT4411 Specifications** (Unless otherwise stated,  $T_a = 25^\circ\text{C}$ ,  $V_{in} = 48\text{ V}$ ,  $V_o = 3.3\text{ V}$ ,  $C_o = 0\text{ }\mu\text{F}$ , and  $I_o = I_{o,max}$ )

Characteristic	Symbol	Conditions	PT4411			Units
			Min	Typ	Max	
Output Current	$I_o$	Over $V_{in}$ range	0	—	30	A
Input Voltage Range	$V_{in}$	Over $I_o$ Range	36	48	75	V
Set Point Voltage Tolerance	$V_o\text{tol}$		—	$\pm 0.6$ (1)	—	$\%V_o$
Temperature Variation	$\text{Reg}_{temp}$	$-40^\circ > T_a > +85^\circ\text{C}$	—	$\pm 0.8$	—	$\%V_o$
Line Regulation	$\text{Reg}_{line}$	Over $V_{in}$ range	—	$\pm 1$	—	mV
Load Regulation	$\text{Reg}_{load}$	Over $I_o$ range	—	$\pm 1$	—	mV
Total Output Voltage Variation	$\Delta V_{o,tot}$	Includes set-point, line, load, $-40^\circ > T_a > +85^\circ\text{C}$	—	$\pm 1.6$	$\pm 3$	$\%V_o$
Efficiency	$\eta$	$I_o = 15\text{ A}$	—	91	—	%
$V_o$ Ripple (pk-pk)	$V_r$	20 MHz bandwidth	—	50	—	mV <sub>pp</sub>
Transient Response	$t_{tr}$	1 A/ $\mu\text{s}$ load step, 50 % to 100 % $I_{o,max}$	—	75	—	$\mu\text{s}$
	$\Delta V_{tr}$	$V_o$ over/undershoot	—	$\pm 5$	—	$\%V_o$
Over-Current Threshold	$I_{TRIP}$	Shutdown, followed by auto-recovery	—	36	—	A
Output Over-Voltage Protection	OVP	Output shutdown and latch off	—	125	—	$\%V_o$
Switching Frequency	$f_o$	Over $V_{in}$ range	250	300	350	kHz
Under-Voltage Lockout	UVLO		—	32	—	V
Remote On/Off Input		Referenced to $-V_{in}$				
Input High Voltage	$V_{IH}$		4.5	—	Open (2)	V
Input Low Voltage	$V_{IL}$		-0.2	—	+0.8	V
Input Low Current	$I_{IL}$		—	-0.3	—	mA
Standby Input Current	$I_{in, standby}$	pins 1 & 2 connected	—	2	—	mA
Internal Input Capacitance	$C_{in}$		—	1.4	—	$\mu\text{F}$
External Output Capacitance	$C_{out}$	Between $+V_o$ and $-V_o$	0	—	5,000	$\mu\text{F}$
Isolation Voltage		Input-output & input-case	1500	—	—	V <sub>dc</sub>
Capacitance		Input-output	—	1200	—	pF
Resistance		Input-output	10	—	—	M $\Omega$

**Notes:** (1) If (-) Remote Sense is not used, pin 12 must be connected to pin 13 for optimum output voltage accuracy.  
 (2) The Remote On/Off input has an internal pull-up. If it is left open-circuit the module will operate when input power is applied. A discrete MOSFET or bipolar transistor is recommended to control this input. The open-circuit voltage is typically 5 V. See application notes for interface considerations.

**PT4411 Characteristic Data**

**Efficiency vs Load Current;  $V_{in} = 48\text{ V}$**  (See Note A)

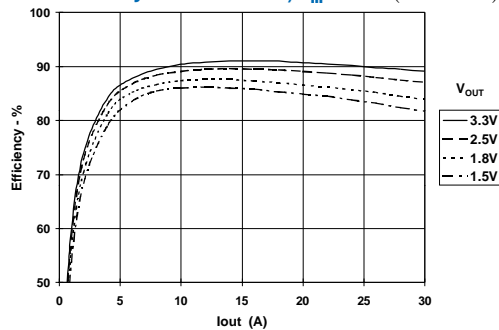

**Power Dissipation vs Load Current;  $V_o = 3.3\text{ V}$**  (See Note A)

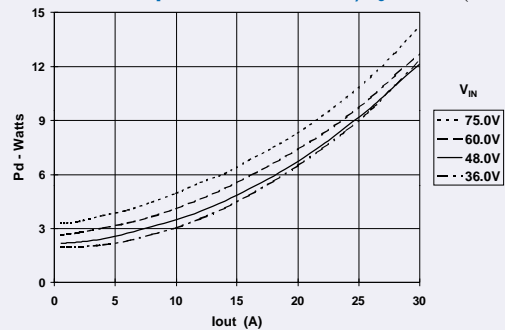

**Output Ripple vs Load Current;  $V_{in} = 48\text{ V}$**  (See Note A)

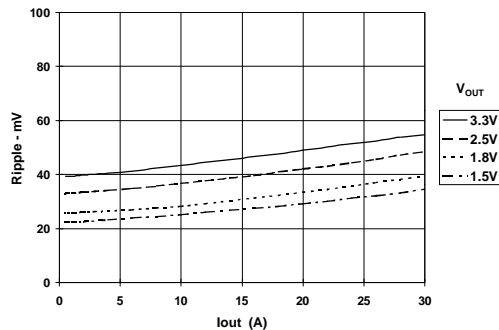

**Safe Operating Area;  $V_{in} = 48\text{ V}$**  (See Note B)

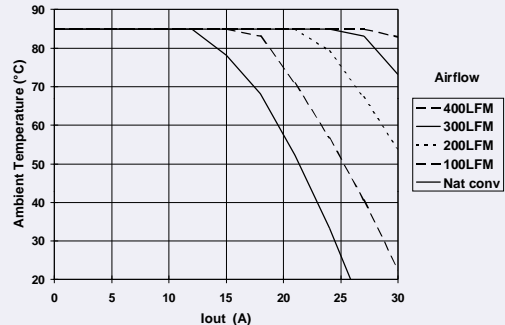

**Note A:** All data listed in the above graphs has been developed from actual products tested at  $25^\circ\text{C}$ . This data is considered typical data for the DC/DC converter.  
**Note B:** SOA curves represent operating conditions at which internal components are at or below manufacturer's maximum rated operating temperature.

**PT4412 Specifications** (Unless otherwise stated,  $T_a = 25^\circ\text{C}$ ,  $V_{in} = 48\text{ V}$ ,  $V_o = 1.5\text{ V}$ ,  $C_o = 0\ \mu\text{F}$ , and  $I_o = I_{o,max}$ )

Characteristic	Symbol	Conditions	PT4412			Units
			Min	Typ	Max	
Output Current	$I_o$	Over $V_{in}$ range	0	—	30	A
Input Voltage Range	$V_{in}$	Over $I_o$ Range	36	48	75	V
Set Point Voltage Tolerance	$V_o\text{tol}$		—	$\pm 0.6$ (1)	—	$\%V_o$
Temperature Variation	$\text{Reg}_{temp}$	$-40^\circ > T_a > +85^\circ\text{C}$	—	$\pm 0.8$	—	$\%V_o$
Line Regulation	$\text{Reg}_{line}$	Over $V_{in}$ range	—	$\pm 1$	—	mV
Load Regulation	$\text{Reg}_{load}$	Over $I_o$ range	—	$\pm 1$	—	mV
Total Output Voltage Variation	$\Delta V_{o,tot}$	Includes set-point, line, load, $-40^\circ > T_a > +85^\circ\text{C}$	—	$\pm 1.6$	$\pm 3$	$\%V_o$
Efficiency	$\eta$	$I_o = 15\text{ A}$	—	86.5	—	%
$V_o$ Ripple (pk-pk)	$V_r$	20 MHz bandwidth	—	30	—	mV <sub>pp</sub>
Transient Response	$t_{tr}$	1 A/ $\mu\text{s}$ load step, 50 % to 75 % $I_{o,max}$	—	75	—	$\mu\text{s}$
	$\Delta V_{tr}$	$V_o$ over/undershoot	—	$\pm 5$	—	$\%V_o$
Over-Current Threshold	$I_{TRIP}$	Shutdown, followed by auto-recovery	—	38	—	A
Output Over-Voltage Protection	OVP	Output shutdown and latch off	—	125	—	$\%V_o$
Switching Frequency	$f_o$	Over $V_{in}$ range	225	275	325	kHz
Under-Voltage Lockout	UVLO		—	32	—	V
Remote On/Off Input		Referenced to $-V_{in}$				
Input High Voltage	$V_{IH}$		4.5	—	Open (2)	V
Input Low Voltage	$V_{IL}$		-0.2	—	+0.8	V
Input Low Current	$I_{IL}$		—	-0.3	—	mA
Standby Input Current	$I_{in, standby}$	pins 1 & 2 connected	—	2	—	mA
Internal Input Capacitance	$C_{in}$		—	1.4	—	$\mu\text{F}$
External Output Capacitance	$C_{out}$	Between $+V_o$ and $-V_o$	0	—	5,000	$\mu\text{F}$
Isolation Voltage		Input-output & input-case	1500	—	—	Vdc
Capacitance		Input-output	—	1200	—	pF
Resistance		Input-output	10	—	—	$\text{M}\Omega$

**Notes:** (1) If (-) Remote Sense is not used, pin 12 must be connected to pin 13 for optimum output voltage accuracy.  
 (2) The Remote On/Off input has an internal pull-up. If it is left open-circuit the module will operate when input power is applied. A discrete MOSFET or bipolar transistor is recommended to control this input. The open-circuit voltage is typically 5 V. See application notes for interface considerations.

**PT4412 Characteristic Data**

**Efficiency vs Load Current;  $V_{in} = 48\text{ V}$**  (See Note A)

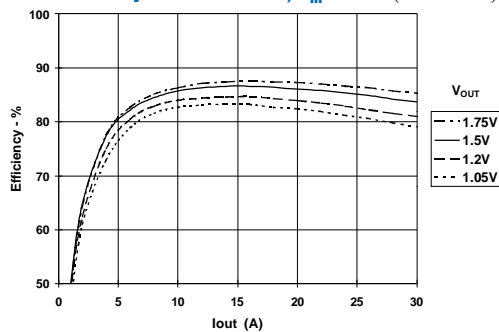

**Power Dissipation vs Load Current;  $V_o = 1.5\text{ V}$**  (See Note A)

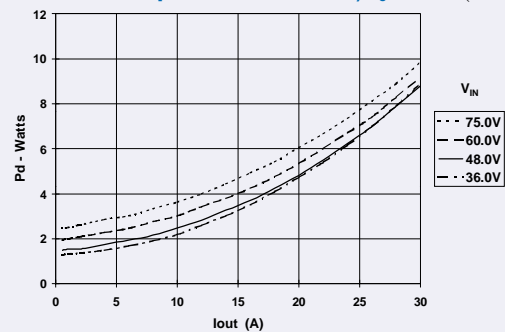

**Output Ripple vs Load Current;  $V_{in} = 48\text{ V}$**  (See Note A)

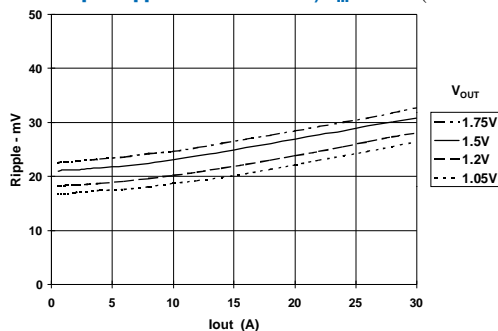

**Safe Operating Area;  $V_{in} = 48\text{ V}$**  (See Note B)

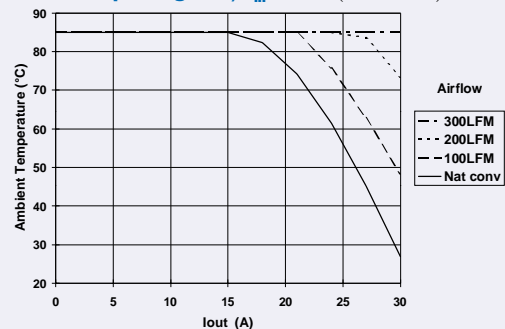

**Note A:** All data listed in the above graphs has been developed from actual products tested at  $25^\circ\text{C}$ . This data is considered typical data for the DC-DC Converter.  
**Note B:** SOA curves represent operating conditions at which internal components are at or below manufacturer's maximum rated operating temperature.

**PT4413 Specifications** (Unless otherwise stated,  $T_a = 25^\circ\text{C}$ ,  $V_{in} = 48\text{ V}$ ,  $V_o = 5.02\text{ V}$ ,  $C_o = 0\ \mu\text{F}$ , and  $I_o = I_{o,max}$ )

Characteristic	Symbol	Conditions	PT4413			Units
			Min	Typ	Max	
Output Current	$I_o$	Over $V_{in}$ range	0	—	20	A
Input Voltage Range	$V_{in}$	Over $I_o$ Range	36	48	75	V
Set Point Voltage Tolerance	$V_o\text{tol}$		—	$\pm 0.6$ (1)	—	$\%V_o$
Temperature Variation	$\text{Reg}_{temp}$	$-40^\circ > T_a > +85^\circ\text{C}$	—	$\pm 0.8$	—	$\%V_o$
Line Regulation	$\text{Reg}_{line}$	Over $V_{in}$ range	—	$\pm 2$	—	mV
Load Regulation	$\text{Reg}_{load}$	Over $I_o$ range	—	$\pm 1$	—	mV
Total Output Voltage Variation	$\Delta V_{o,tot}$	Includes set-point, line, load, $-40^\circ > T_a > +85^\circ\text{C}$	—	$\pm 1.6$	$\pm 3$	$\%V_o$
Efficiency	$\eta$	$I_o = 15\text{ A}$	—	92	—	%
$V_o$ Ripple (pk-pk)	$V_r$	20MHz bandwidth	—	70	—	mV <sub>pp</sub>
Transient Response	$t_{tr}$	1 A/ $\mu\text{s}$ load step, 50 % to 100 % $I_{o,max}$	—	75	—	$\mu\text{s}$
	$\Delta V_{tr}$	$V_o$ over/undershoot	—	$\pm 2$	—	$\%V_o$
Over-Current Threshold	$I_{TRIP}$	Shutdown, followed by auto-recovery	—	28	—	A
Output Over-Voltage Protection	OVP	Output shutdown and latch off	—	125	—	$\%V_o$
Switching Frequency	$f_o$	Over $V_{in}$ range	250	300	350	kHz
Under-Voltage Lockout	UVLO		—	32	—	V
Remote On/Off Input		Referenced to $-V_{in}$				
Input High Voltage	$V_{IH}$		4.5	—	Open (2)	V
Input Low Voltage	$V_{IL}$		-0.2	—	+0.8	V
Input Low Current	$I_{IL}$		—	-0.3	—	mA
Standby Input Current	$I_{in\text{ standby}}$	pins 1 & 2 connected	—	2	—	mA
Internal Input Capacitance	$C_{in}$		—	1.4	—	$\mu\text{F}$
External Output Capacitance	$C_{out}$	Between $+V_o$ and $-V_o$	0	—	5,000	$\mu\text{F}$
Isolation Voltage		Input-output & input-case	1500	—	—	Vdc
Capacitance		Input-output	—	1200	—	pF
Resistance		Input-output	10	—	—	$\text{M}\Omega$

- Notes:** (1) If (-) Remote Sense is not used, pin 12 must be connected to pin 13 for optimum output voltage accuracy.  
 (2) The Remote On/Off input has an internal pull-up. If it is left open-circuit the module will operate when input power is applied. A discrete MOSFET or bipolar transistor is recommended to control this input. The open-circuit voltage is typically 5 V. See application notes for interface considerations.

**PT4413 Characteristic Data**

**Efficiency vs Load Current;  $V_{OUT} = 5.02\text{ V}$**  (See Note A)

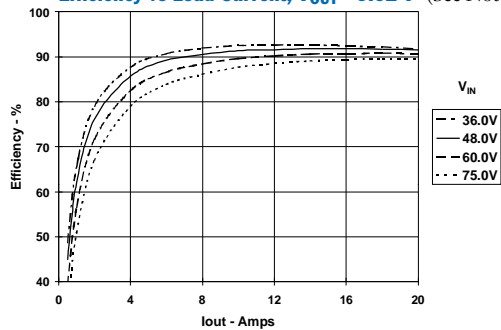

**Power Dissipation vs Load;  $V_{OUT} = 5.02\text{ V}$**  (See Note A)

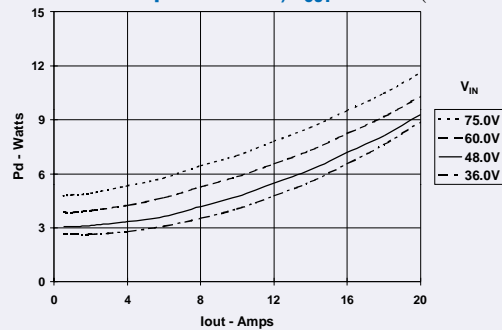

**Output Ripple vs Load Current;  $V_{OUT} = 5.02\text{ V}$**  (See Note A)

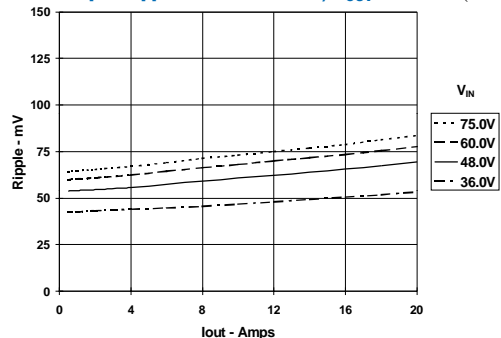

**Safe Operating Area;  $V_{in} = 48\text{ V}$**  (See Note B)

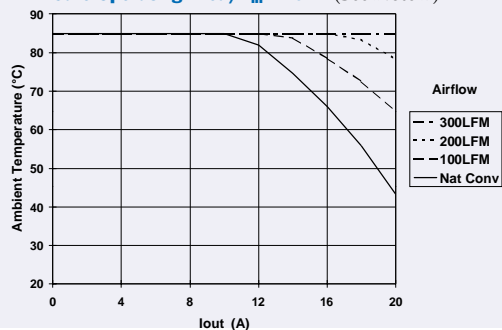

**Note A:** All data listed in the above graphs has been developed from actual products tested at  $25^\circ\text{C}$ . This data is considered typical data for the DC/DC converter.  
**Note B:** SOA curves represent operating conditions at which internal components are at or below manufacturer's maximum rated operating temperature.

## Operating Features and System Considerations for the PT4400/PT4410 Series of DC/DC Converters

### Over-Current Protection

To protect against load faults these converters incorporate output over-current protection. Applying a load to the output that exceeds the converter's over-current threshold (see applicable specification) will cause the output voltage to momentarily fold back, and then shut down. Following shutdown the module will periodically attempt to automatically recover by initiating a soft-start power-up. This is often described as a "hiccup" mode of operation, whereby the module continues in the cycle of successive shutdown and power up until the load fault is removed. Once the fault is removed, the converter automatically recovers and returns to normal operation.

### Output Over-Voltage Protection

Each converter incorporates protection circuitry that continually senses for an output overvoltage (OV) condition. The OV threshold automatically tracks the VID output voltage program setting to a level that is 25 % higher than that programmed at the control pins, VID0 through VID4. If the converter output voltage exceeds this threshold, the converter is immediately shut down and remains in a latched-off state. To resume normal operation the converter must be actively reset. This can only be done by momentarily removing the input power to the converter. For failsafe operation and redundancy, the OV protection uses circuitry that is independent of the converter's internal feedback loop.

### Over-Temperature Protection

Over-temperature protection is provided by an internal temperature sensor, which closely monitors the temperature of the converter's metal case. If the case temperature exceeds a nominal 115 °C, the converter will shut down. The converter will then automatically restart when the sensed temperature drops back to approximately 105 °C. When operated outside its recommended thermal derating envelope (see data sheet SOA curves), the converter will typically cycle on and off at intervals from a few seconds to one or two minutes. This is to ensure that the internal components are not permanently damaged from excessive thermal stress.

### Under-Voltage Lockout

The Under-Voltage Lock-Out (UVLO) is designed to prevent the operation of the converter until the input voltage is close to the minimum input voltage. The converter is held off when the input voltage is below the UVLO threshold, and turns on when the input voltage rises above the threshold. This prevents high start-up current during normal power-up of the converter, and

minimizes the current drain from the input source during low input voltage conditions. The converter will meet full specifications when the minimum specified input voltage is reached. The UVLO circuitry also overrides the operation of the *Remote On/Off* control. Only when the input voltage is above the UVLO threshold will the *Remote On/Off* control be functional.

### Primary-Secondary Isolation

These converters incorporate electrical isolation between the input terminals (primary) and the output terminals (secondary). All converters are production tested to a withstand voltage of 1500VDC. This specification complies with UL60950 and EN60950 and the requirements for operational isolation. This allows the converter to be configured for either a positive or negative input voltage source. The data sheet 'Pin Descriptions' section provides guidance as to the correct reference that must be used for the external control signals.

### Input Current Limiting

**The converter is not internally fused.** For safety and overall system protection, the maximum input current to the converter must be limited. Active or passive current limiting can be used. Passive current limiting can be a fast acting fuse. A 125-V fuse, rated no more than 10 A, is recommended. Active current limiting can be implemented with a current limited "Hot-Swap" controller.

### Thermal Considerations

Airflow may be necessary to ensure that the module can supply the desired load current in environments with elevated ambient temperatures. The required airflow rate may be determined from the Safe Operating Area (SOA) thermal derating chart (see converter specifications). The recommended direction for airflow is into, or perpendicular to, the longest side of the module's metal case. See Figure 1.

Figure 1

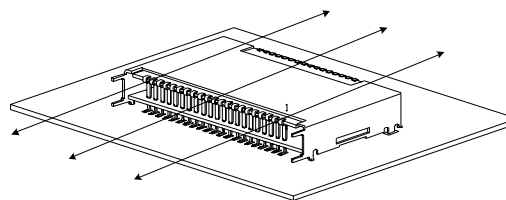

Recommended direction for airflow is into (perpendicular to) the longest side.

### Using the Remote On/Off Function on the PT4400/PT4410 Series of DC/DC Converters

For applications requiring output voltage On/Off control, these converters incorporate a “Remote On/Off” control (pin 1). This feature can be used to switch the module off without removing the applied input source voltage.

The converter functions normally with Pin 1 open-circuit, providing a regulated output voltage when a valid source voltage is applied to +V<sub>in</sub> (pins 4, 5), with respect to -V<sub>in</sub> (pins 2, 3). When a low-level 1 ground signal is applied to pin 1, the converter output will be turned off.

Figure 1 is an application schematic, which shows the typical use of the Remote On/Off function. Note the discrete transistor (Q<sub>1</sub>). The Remote On/Off pin has its own internal pull-up, allowing it to be controlled with an open-collector or open-drain device (See notes 2 & 3). Table 1 gives the threshold requirements.

When placed in the “Off” state, the standby current drawn from the input source is typically reduced to less than 1mA.

**Table 1; Pin 1 Remote On/Off Control Requirements <sup>1</sup>**

Parameter	Min	Typ	Max
Enable (V <sub>IH</sub> )	4.5 V	—	—
Disable (V <sub>IL</sub> )	—	—	0.8 V
V <sub>o/c</sub> [Open-Circuit]	—	5.0 V	—
I <sub>in</sub> [pin 1 at -V <sub>in</sub> ]	—	—	-0.5 mA

#### Notes:

1. The Remote On/Off control uses -V<sub>in</sub> (pins 2, 3) as its ground reference. All voltages are with respect to -V<sub>in</sub>.
2. Use an open-collector device (preferably a discrete transistor) for the Remote On/Off input. A pull-up resistor is not necessary. To disable the output voltage, the control pin should be pulled low to less than +0.8 V.
3. The Remote On/Off pin may be controlled with devices that have a totem-pole output. This is provided the output high-level voltage (V<sub>OH</sub>) meets the module’s minimum V<sub>IH</sub> specified in Table 1. *Do not* apply more than +20 V. If a TTL gate is used, a pull-up resistor may be required to the logic supply voltage.
4. The converter incorporates an “Under-Voltage Lockout” (UVLO). The UVLO keeps the converter off until the input voltage is close to the minimum specified operating voltage. This is regardless of the state of the Remote On/Off control. Table 2 gives the UVLO input voltage thresholds.

**Table 2; UVLO Thresholds <sup>4</sup>**

Series	V <sub>in</sub> Range	UVLO Threshold
PT4400/4410	36 – 75 V	32V ±2 V

**Figure 1**

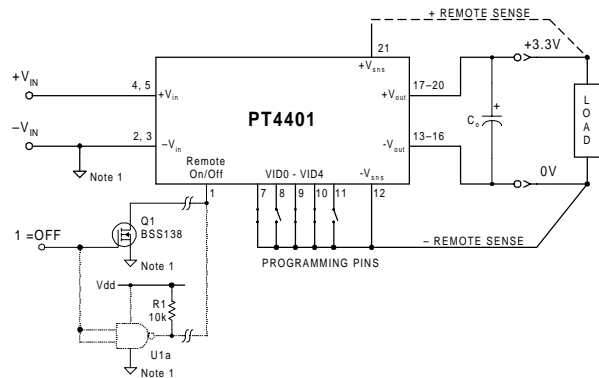

**Turn-On Time:** In the circuit of Figure 1, turning Q<sub>1</sub> on applies a low-voltage to pin 1 and disables the converter output. Correspondingly, turning Q<sub>1</sub> off allows pin 1 to be pulled high by an internal pull-up resistor. The converter produces a regulated output voltage within 50ms. Figure 2 shows the output response of a PT4401 following the turn-off of Q<sub>1</sub>. The turn off of Q<sub>1</sub> corresponds to the drop in Q<sub>1</sub> V<sub>gs</sub>. Although the rise-time of the output voltage is short (<5 ms), the indicated delay time will vary depending upon the input voltage and the module’s internal timing. The output voltage of the PT4401 was set to 3.3 V by connecting VID0 (pin 7), VID2 (pin 9), and VID3 (pin 10) to the (-)Remote Sense (pin 12). The waveforms were measured with 48 VDC input voltage, and a 10 A resistive load.

**Figure 2**

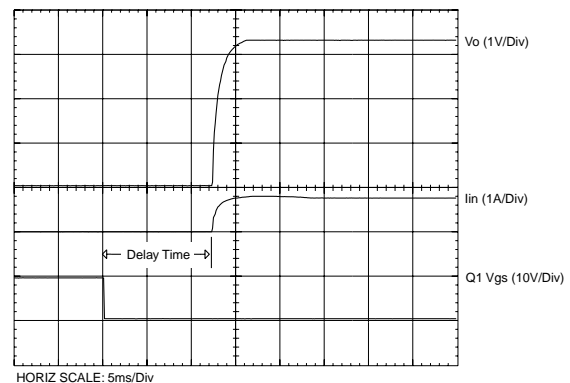

### Pin-Coded Output Voltage Adjustment on the PT4400/4410 Series of DC/DC Converters

These DC/DC converters have a programmable output voltage. In each case the desired output voltage must be selected from one of a number of discrete voltages using the voltage programming control pins. Depending on each model's resolution and adjustment range, there are up to five control pins. They are identified *VID0-VID4* (pins 7-11) respectively. By selectively strapping these control pins to (-)Remote Sense (pin 12), the output voltage can be programmed to one of up to 32 different values over the defined output voltage range. The program code and output voltage range of the PT4401/4411 is also compatible with the "Voltage ID" code defined in the Intel® VRM 8.2 specification. Refer to the applicable product specification sheet for the program code.

#### Notes:

- The programming convention is as follows:-  
 Logic 0: Connect to pin 12 (-Remote Sense).  
 Logic 1: Open circuit/open drain (See notes 2, & 4)
- Do not connect pull-up resistors to the voltage programming pins.
- To minimize output voltage error, always use pin 12 (-Remote Sense) as the logic "0" reference. While -V<sub>out</sub> (pins 13-16) can also be used for programming, doing so will degrade the voltage selection accuracy and load regulation of the product.
- When VID0-VID4 are all open circuit (logic 1), the output voltage is undefined. In this state the output voltage of the converter cannot be guaranteed, and can vary with output load and input voltage.
- On all models other than the PT4401/4411, the control

input VID4 (pin 11) is internally disabled and is not functional.

- If active devices are used to ground the voltage control pins, low-level open drain MOSFET devices should be used over bipolar transistors. The inherent  $V_{ce(sat)}$  in bipolar devices introduces errors in the device's internal voltage control circuit. Discrete transistors such as the BSS138 or IRLML2402 are examples of appropriate devices.

#### Active Voltage Programming:

Special precautions should be taken when making changes to the voltage program code while the output is active. This activity induces a transient, which may activate the module's output over-voltage (OV) protection. Once triggered the OV protection circuit latches the output off, and requires the momentary removal of input power to reset the module. OV protection trips can be avoided by limiting the output voltage adjustment to no more than a 15 % change from the initial voltage. Large transitions are best made with a series of incremental changes, allowing 100  $\mu$ s settling time between each program state. When using active devices to program the output voltage, their state should be asserted prior to input power being applied. An alternative is to pull pin 1 (Remote On/Off) to -V<sub>in</sub> (pins 2, 3) during the application of power, assert the required program code, and then release pin 1. The module will then initiate a soft-start power-up to the desired program voltage.

Figure 1

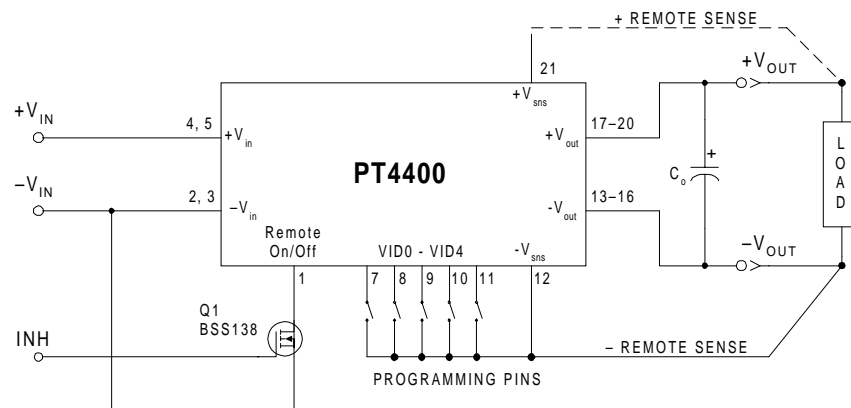



### PCB Dual Layout for PT4400/4410 and ¼-Brick Package Alternate Build Option

The PCB footprint for the horizontal package versions (suffixes A & C) of the PT4400 and PT4410 series are dimensionally similar to a standard quarter-brick outline, making it easy to accommodate either package on the host PCB. This can provide the option for a second source, or in the case of the PT4400/4410 product, the added functionality of VID output voltage selection in a surface mount compatible package.

Figure 4-1 shows an example of an alternate PCB layout that will accommodate the surface mount version of the PT product (package code ENP). It should be noted that Figure 4-1 is a dimensionless drawing and is offered only as a guide. Please refer to the respective package outline drawing and PCB layout recommendations for the products actually employed. As an additional reference, Table 4-1 provides the pin-out for the PT4400/4410 series product.

**Table 4-1; PT4400/4410 Pin-Out Reference**

PT4400/4410	
Pin	Function
1	Remote On/Off
2	-V <sub>in</sub>
3	-V <sub>in</sub>
4	+V <sub>in</sub>
5	+V <sub>in</sub>
6	Pin Not Present
7	VID 0
8	VID 1
9	VID 2
10	VID 3
11	VID 4
12	Sense (-)
13	-V <sub>out</sub>
14	-V <sub>out</sub>
15	-V <sub>out</sub>
16	-V <sub>out</sub>
17	+V <sub>out</sub>
18	+V <sub>out</sub>
19	+V <sub>out</sub>
20	+V <sub>out</sub>
21	Sense (+)

**Figure 4-1; Example PCB Layout for PT4400/4410 and ¼-Brick Package Alternate Build**

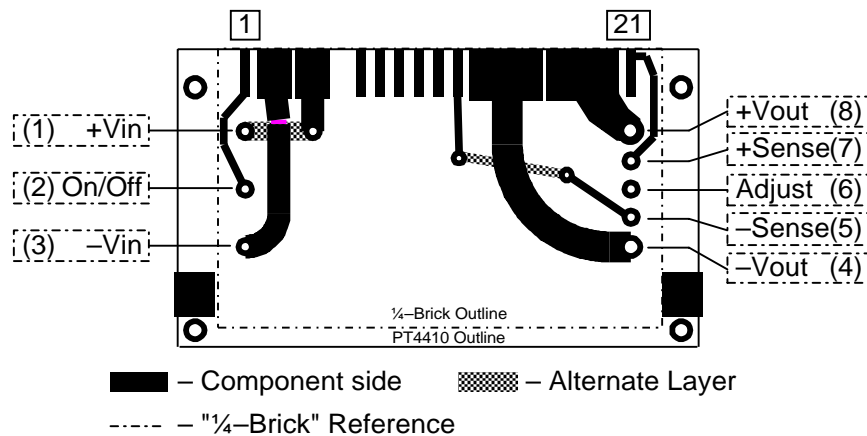

## IMPORTANT NOTICE

Texas Instruments Incorporated and its subsidiaries (TI) reserve the right to make corrections, modifications, enhancements, improvements, and other changes to its products and services at any time and to discontinue any product or service without notice. Customers should obtain the latest relevant information before placing orders and should verify that such information is current and complete. All products are sold subject to TI's terms and conditions of sale supplied at the time of order acknowledgment.

TI warrants performance of its hardware products to the specifications applicable at the time of sale in accordance with TI's standard warranty. Testing and other quality control techniques are used to the extent TI deems necessary to support this warranty. Except where mandated by government requirements, testing of all parameters of each product is not necessarily performed.

TI assumes no liability for applications assistance or customer product design. Customers are responsible for their products and applications using TI components. To minimize the risks associated with customer products and applications, customers should provide adequate design and operating safeguards.

TI does not warrant or represent that any license, either express or implied, is granted under any TI patent right, copyright, mask work right, or other TI intellectual property right relating to any combination, machine, or process in which TI products or services are used. Information published by TI regarding third-party products or services does not constitute a license from TI to use such products or services or a warranty or endorsement thereof. Use of such information may require a license from a third party under the patents or other intellectual property of the third party, or a license from TI under the patents or other intellectual property of TI.

Reproduction of information in TI data books or data sheets is permissible only if reproduction is without alteration and is accompanied by all associated warranties, conditions, limitations, and notices. Reproduction of this information with alteration is an unfair and deceptive business practice. TI is not responsible or liable for such altered documentation.

Resale of TI products or services with statements different from or beyond the parameters stated by TI for that product or service voids all express and any implied warranties for the associated TI product or service and is an unfair and deceptive business practice. TI is not responsible or liable for any such statements.

Following are URLs where you can obtain information on other Texas Instruments products & application solutions:

<b>Products</b>		<b>Applications</b>	
Amplifiers	<a href="http://amplifier.ti.com">amplifier.ti.com</a>	Audio	<a href="http://www.ti.com/audio">www.ti.com/audio</a>
Data Converters	<a href="http://dataconverter.ti.com">dataconverter.ti.com</a>	Automotive	<a href="http://www.ti.com/automotive">www.ti.com/automotive</a>
DSP	<a href="http://dsp.ti.com">dsp.ti.com</a>	Broadband	<a href="http://www.ti.com/broadband">www.ti.com/broadband</a>
Interface	<a href="http://interface.ti.com">interface.ti.com</a>	Digital Control	<a href="http://www.ti.com/digitalcontrol">www.ti.com/digitalcontrol</a>
Logic	<a href="http://logic.ti.com">logic.ti.com</a>	Military	<a href="http://www.ti.com/military">www.ti.com/military</a>
Power Mgmt	<a href="http://power.ti.com">power.ti.com</a>	Optical Networking	<a href="http://www.ti.com/opticalnetwork">www.ti.com/opticalnetwork</a>
Microcontrollers	<a href="http://microcontroller.ti.com">microcontroller.ti.com</a>	Security	<a href="http://www.ti.com/security">www.ti.com/security</a>
		Telephony	<a href="http://www.ti.com/telephony">www.ti.com/telephony</a>
		Video & Imaging	<a href="http://www.ti.com/video">www.ti.com/video</a>
		Wireless	<a href="http://www.ti.com/wireless">www.ti.com/wireless</a>

Mailing Address: Texas Instruments  
Post Office Box 655303 Dallas, Texas 75265