

Applications

- Distributed power architectures
- Telecommunications equipment
- LAN/WAN applications
- Data processing
- Industrial applications

Features

- RoHS lead-free-solder and lead-solder-exempted products are available
- Basic isolation
- 1500 VDC i/o electric strength test voltage
- High current density
- Output overcurrent protection
- Operating temperature up to 100 °C
- Remote shutdown (primary referenced), negative logic option available
- Output voltage adjust, positive or negative
- Low profile SMT design: 8.3 mm (RDS)
- Excellent co-planarity (within 0.1 mm)
- Safety-approved to IEC/EN 60950-1 and UL/CSA 60950-1 2nd Ed.

Description

The RFS and RDS Series converters are low profile, single output, DC-DC converters intended for SMT placement and reflow soldering. The product provides onboard conversion of standard telecom and datacom input voltages to isolated low output

voltages. Proprietary patented manufacturing processes with full process automation ensure optimal product quality. These are very high performance, cost effective converters with a very small PCB footprint.

Model Selection

| Model | Input Voltage VDC | Input Current A | Output Voltage V | Output Rated Current A | Output Ripple/Noise mVpp | Typical Efficiency % |
|---------------------------|----------------------|-----------------|------------------|------------------------|--------------------------|----------------------|
| RFS06ZA-M6 ¹ | 36 – 75 | 0.35 | 1.5 | 6.0 | 70 | 77 |
| RFS06ZB-M6 ¹ | 36 – 75 | 0.45 | 1.8 | 6.0 | 70 | 79 |
| RDS06ZB-M6 ^{1 2} | 36 – 75 | 0.65 | 1.8 | 6.0 | 75 | 80 |
| RFS06ZD-M6 ¹ | 36 – 75 | 0.55 | 2.5 | 6.0 | 75 | 83 |
| RFS06ZE-M6 ¹ | 36 ³ – 75 | 0.65 | 3.3 | 6.0 | 75 | 85 |
| RDS05ZE-M6 ^{1 2} | 36 ³ – 75 | 0.65 | 3.3 | 5.0 | 75 | 83 |
| RFS04ZG-M6 ¹ | 36 ³ – 75 | 0.65 | 5.0 | 4.0 | 50 | 87 |
| RDS04ZG-M6 ^{1 2} | 36 ³ – 75 | 0.65 | 5.0 | 4.0 | 50 | 87 |

¹ For products RoHS-compliant for all 6 substances, change the suffix **M6** to **M6G**.

² For negative shutdown logic, change **-M6** to **-NM6** or **-M6G** to **-NM6G**

³ Products with $V_i = 33.5 - 75$ V are also available: Replace **M6** by **S1**.

 Model numbers highlighted in yellow are not recommended for new designs.

Absolute Maximum Ratings

Stresses in excess of the absolute maximum ratings may cause performance degradation, adversely affect long term reliability and cause permanent damage to the converter. Specifications apply over specified input voltage, output load, and temperature range, unless otherwise noted.

| Parameter | Conditions/Description | Min | Max | Unit |
|--------------------------------------|------------------------|------|-----|------|
| Input voltage (V_i) | Continuous | 36 | 75 | VDC |
| Transient Input Voltage (V_{it}) | Transient, 100 ms | | 100 | VDC |
| Operating Case Temp. (T_c) | At 100% load | -40 | 100 | °C |
| Storage Temperature (T_s) | | -55 | 120 | °C |
| ON/OFF Control Voltage (V_{RC}) | Referenced to $-V_i$ | -1.0 | 5.5 | V |

Environmental and Mechanical

Specifications apply over specified input voltage, output load and temperature range, unless otherwise noted.

| Parameter | Conditions/Description | Min | Nom | Max | Unit |
|----------------------|------------------------------------------------------|-----|-----------|-----|-------|
| Shock | IEC68-2-27 | | | 100 | g_n |
| Sinusoidal Vibration | IEC68-2-6 | | | 10 | g_n |
| Weight | | | | 17 | g |
| Water Washing | Standard process | Yes | | | N/A |
| MTBF of RFS models | Per Bellcore TR-NWT-000332 (100% load @25 °C, GB) | | 1 453 000 | | h |
| MTBF of RDS models | | | 1 452 000 | | h |

Isolation

Specifications apply over specified input voltage, output load and temperature range, unless otherwise noted.

| Parameter | Conditions/Description | Min | Nom | Max | Unit |
|--------------------------------|-------------------------------------------|-----|-------------------------|-----|------|
| Insulation Safety Rating | $V_i = 75$ VDC | | Basic | | N/A |
| Electric Strength Test Voltage | | | 1 500 | | VDC |
| Insulation Resistance | | 10 | | | MOhm |
| Insulation Capacitance | RFS models RDS06ZB RDS04ZG, RDS05ZE | | 8 200 4 700 2 200 | | pF |

Input Data

Specifications apply over specified input voltage, output load and temperature range, unless otherwise noted.

| Parameter | Conditions/Description | Min | Nom | Max | Unit |
|-------------------------------------------------|-------------------------------------------------------------|----------|-------------------------|----------|-------------------------|
| Input Voltage (V_i) | Continuous | 36 | 48 | 75 | VDC |
| Input Current when Shutdown | $V_{i\text{nom}}$, Remote Control activated | | 3 | 10 | mA |
| Turn-On Input Voltage | Ramping up, $I_{o\text{max}}$ | 32 | 34 | 36 | V |
| Turn-Off Input Voltage RFS models RDS models | Ramping down, $I_{o\text{max}}$ | 31 30 | 33 32 | 35 34 | |
| Turn-On Time, RFS/RDS models | T_o Output Regulation Band After Remote Control Rise Time | | 300/600 30/30 5/5 | | ms |
| Input Reflected Ripple Current | $V_{i\text{max}}$, $I_{o\text{max}}$ | | | 50 | mA_{pp} |
| Input Capacitance | | | | 1.4 | μF |

Output Data

RFS06ZA: 1.5 V / 6.0 A

All specifications apply over input voltage, output load and temperature range, unless otherwise noted.

| Parameter | | Conditions/Description | Min | Nom | Max | Unit |
|------------------------------------|-------|-----------------------------------------------------------------------------|------|-----|-----------|------------------------|
| Output Voltage Setpoint Accuracy | V_o | $V_{i\text{ nom}}, I_o = 3.0\text{ A}, 25\text{ }^\circ\text{C}$ | 1.48 | 1.5 | 1.52 | V |
| Output Current | I_o | $V_{i\text{ min}} - V_{i\text{ max}}$ | 0 | | 6.0 | A |
| Line Regulation | | $V_{i\text{ min}} - V_{i\text{ max}}, 50\% I_{o\text{ max}}$ | | | 30 | mV |
| Load Regulation | | $V_{i\text{ nom}}, I_{o\text{ min}} - I_{o\text{ max}}$ | | | 30 | mV |
| Dynamic Regulation Peak Deviation | | 50 – 100% $I_{o\text{ max}}$ load step change. to 1% error band | | | ± 150 | mV |
| Settling Time | | | | | 1000 | μs |
| Output Voltage Ripple ¹ | | $V_{i\text{ min}} - V_{i\text{ max}}, I_{o\text{ max}}$ 20 MHz Bandwidth | | 70 | 85 | mV _{pp} |
| Admissible Load Capacitance | | $I_{o\text{ max}}, V_{i\text{ nom}}$ | | | 2200 | μF |
| Output Current Limit Threshold | | $V_o \leq 0.90 V_{o\text{ nom}}$ | 120 | | 200 | % $I_{o\text{ max}}$ |
| Switching Frequency | | $V_{i\text{ nom}}, I_{o\text{ max}}$ | | 220 | | kHz |
| Temperature Coefficient | | | | | 0.02 | % $V_o/^\circ\text{C}$ |
| Trim Range | | $I_{o\text{ min}} - I_{o\text{ max}}, V_{i\text{ min}} - V_{i\text{ max}}$ | 1.35 | | 1.65 | V |

¹ Measured with a 1 μF capacitor across the output pins.

Typical Characteristic Curves

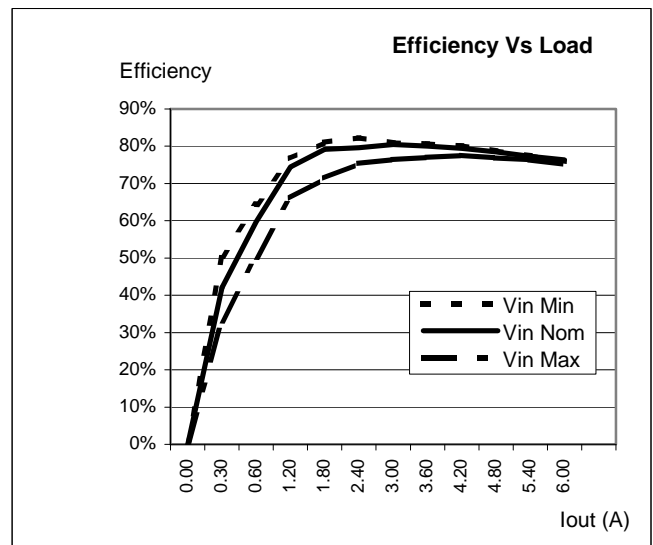
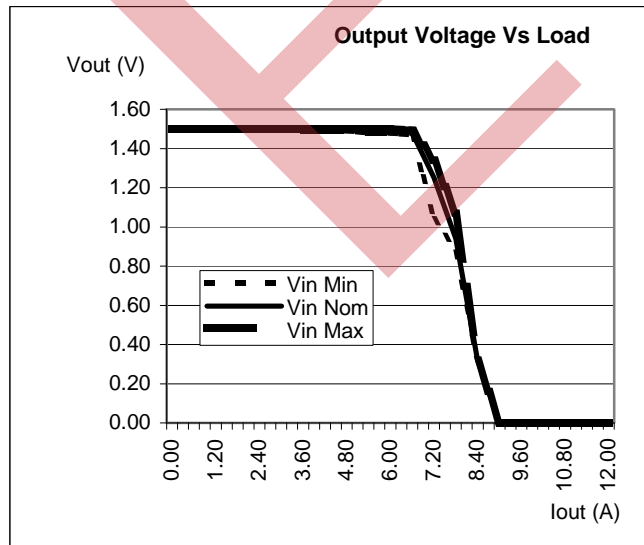

RFS06ZB: 1.8 V / 6.0 A

All specifications apply over input voltage, output load and temperature range, unless otherwise noted.

| Parameter | | Conditions/Description | Min | Nom | Max | Unit |
|------------------------------------|-------|-----------------------------------------------------------------------------|------|-----|------|----------------------|
| Output Voltage Setpoint Accuracy | V_o | $V_{i\text{ nom}}, I_o = 3.0\text{ A}, 25\text{ }^\circ\text{C}$ | 1.78 | 1.8 | 1.82 | V |
| Output Current | I_o | $V_{i\text{ min}} - V_{i\text{ max}}$ | 0 | | 6.0 | A |
| Line Regulation | | $V_{i\text{ min}} - V_{i\text{ max}}, 50\% I_{o\text{ max}}$ | | | 36 | mV |
| Load Regulation | | $V_{i\text{ nom}}, I_{o\text{ min}} - I_{o\text{ max}}$ | | | 36 | mV |
| Dynamic Regulation Peak Deviation | | 50 – 100% $I_{o\text{ max}}$ load step change. to 1% error band | | | ±150 | mV |
| Settling Time | | | | | 1000 | µs |
| Output Voltage Ripple ¹ | | $V_{i\text{ min}} - V_{i\text{ max}}, I_{o\text{ max}}$ 20 MHz Bandwidth | | 70 | 85 | mV _{pp} |
| Admissible Load Capacitance | | $I_{o\text{ max}}, V_{i\text{ nom}}$ | | | 2200 | µF |
| Output Current Limit Threshold | | $V_o \leq 0.90 V_{o\text{ nom}}$ | 120 | | 200 | % $I_{o\text{ max}}$ |
| Switching Frequency | | $V_{i\text{ nom}}, I_{o\text{ max}}$ | | 220 | | kHz |
| Temperature Coefficient | | | | | 0.02 | % V_o /°C |
| Trim Range | | $I_{o\text{ min}} - I_{o\text{ max}}, V_{i\text{ min}} - V_{i\text{ max}}$ | 1.62 | | 1.98 | V |

¹ Measured with a 1 µF capacitor across the output pins.

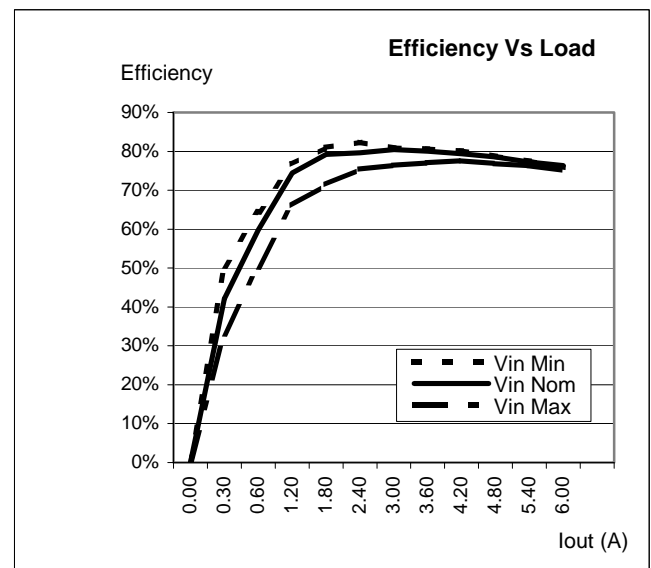
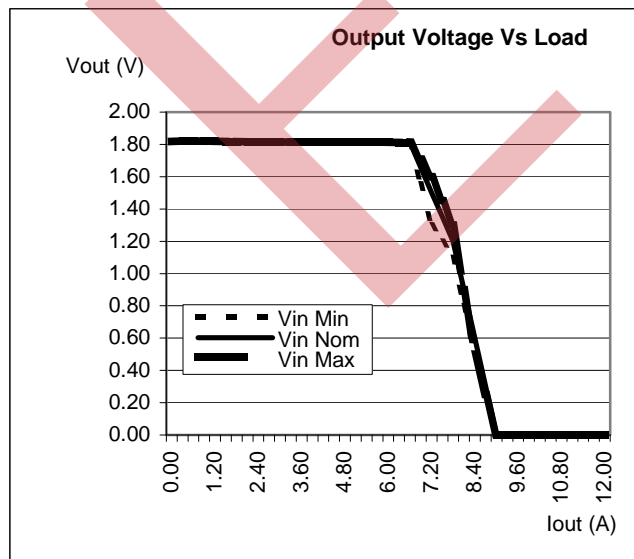
Typical Characteristic Curves

RDS06ZB: 1.8 V / 6.0 A

| Parameter | | Conditions/Description | Min | Nom | Max | Unit |
|-----------------------------------|-------|-----------------------------------------------------------------------------|------|-----|------|----------------------|
| Output Voltage Setpoint Accuracy | V_o | $V_{i\text{ nom}}, I_o = 3.0\text{ A}, 25\text{ }^\circ\text{C}$ | 1.78 | 1.8 | 1.82 | V |
| Output Current | I_o | $V_{i\text{ min}} - V_{i\text{ max}}$ | 0 | | 6.0 | A |
| Line Regulation | | $V_{i\text{ min}} - V_{i\text{ max}}, 50\% I_{o\text{ max}}$ | | | 36 | mV |
| Load Regulation | | $V_{i\text{ nom}}, I_{o\text{ min}} - I_{o\text{ max}}$ | | | 36 | mV |
| Dynamic Regulation Peak Deviation | | 50 – 100% $I_{o\text{ max}}$ load step change. to 1% error band | | | ±150 | mV |
| Settling Time | | | | | 500 | µs |
| Output Voltage Ripple | | $V_{i\text{ min}} - V_{i\text{ max}}, I_{o\text{ max}}$ 20 MHz Bandwidth | | 75 | 100 | mV _{pp} |
| Admissible Load Capacitance | | $I_{o\text{ max}}, V_{i\text{ nom}}$ | | | 2200 | µF |
| Output Current Limit Threshold | | $V_o \leq 0.90 V_{o\text{ nom}}$ | 120 | | 200 | % $I_{o\text{ max}}$ |
| Switching Frequency | | $V_{i\text{ nom}}, I_{o\text{ max}}$ | | 400 | | kHz |
| Temperature Coefficient | | | | | 0.02 | % V_o /°C |
| Trim Range | | $I_{o\text{ min}} - I_{o\text{ max}}, V_{i\text{ min}} - V_{i\text{ max}}$ | 1.62 | | 1.98 | V |

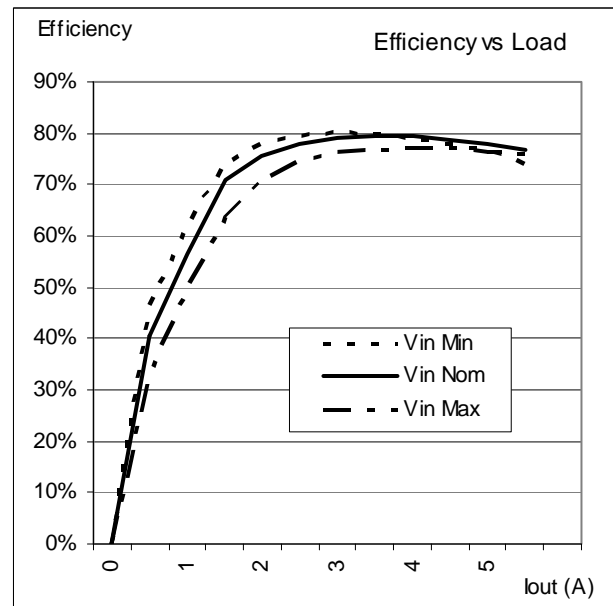
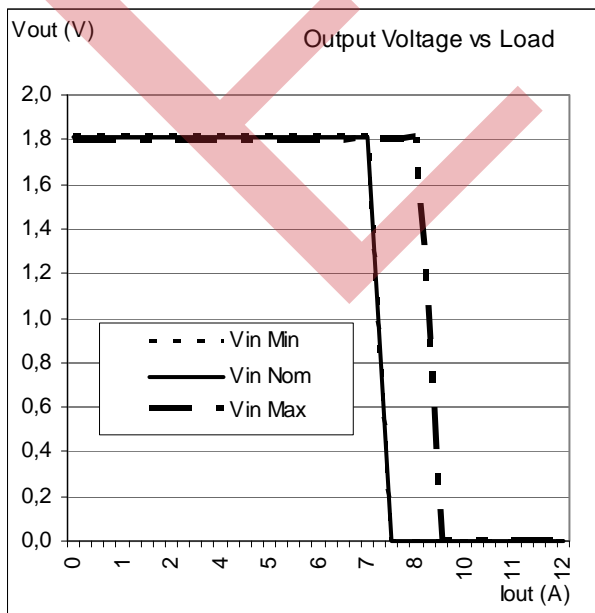
Typical Characteristic Curves

RFS06ZD: 2.5 V / 6.0 A

All specifications apply over input voltage, output load and temperature range, unless otherwise noted.

| Parameter | | Conditions/Description | Min | Nom | Max | Unit |
|--------------------------------------|-------|-----------------------------------------------------------------------------|------|-----|------|----------------------|
| Output Voltage Setpoint Accuracy | V_o | $V_{i\text{ nom}}, I_o = 3.0\text{ A}, 25\text{ }^\circ\text{C}$ | 2.47 | 2.5 | 2.53 | V |
| Output Current | I_o | $V_{i\text{ min}} - V_{i\text{ max}}$ | 0 | | 6.0 | A |
| Line Regulation | | $V_{i\text{ min}} - V_{i\text{ max}}, 50\% I_{o\text{ max}}$ | | | 50 | mV |
| Load Regulation | | $V_{i\text{ nom}}, I_{o\text{ min}} - I_{o\text{ max}}$ | | | 50 | mV |
| Dynamic Regulation Peak Deviation | | 50 – 100% $I_{o\text{ max}}$ load step change. | | | ±150 | mV |
| Settling Time | | to 1% error band | | | 1000 | µs |
| Output Voltage Ripple ¹ | | $V_{i\text{ min}} - V_{i\text{ max}}, I_{o\text{ max}}$ 20 MHz Bandwidth | | 75 | 100 | mV _{pp} |
| Admissible Load Capacitance | | $I_{o\text{ max}}, V_{i\text{ nom}}$ | | | 2200 | µF |
| Output Current Limit Threshold | | $V_o \leq 0.90 V_{o\text{ nom}}$ | 120 | | 200 | % $I_{o\text{ max}}$ |
| Switching Frequency | | $V_{i\text{ nom}}, I_{o\text{ max}}$ | | 220 | | kHz |
| Temperature Coefficient | | | | | 0.02 | % V_o /°C |
| Trim Range | | $I_{o\text{ min}} - I_{o\text{ max}}, V_{i\text{ min}} - V_{i\text{ max}}$ | 2.25 | | 2.75 | V |

¹ Measured with a 1 µF capacitor across the output pins.

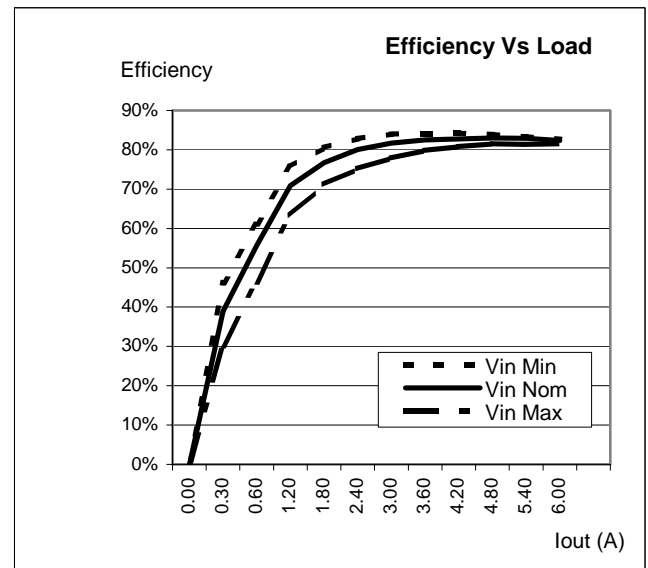
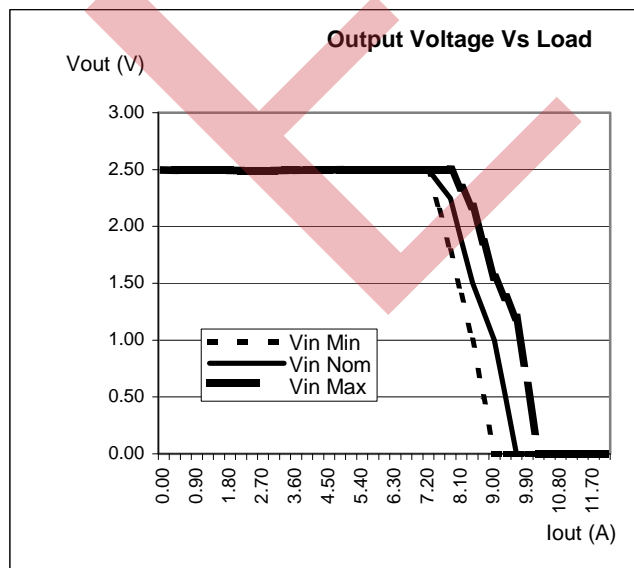
Typical Characteristic Curves

RFS06ZE: 3.3 V / 6.0 A

All specifications apply over input voltage, output load and temperature range, unless otherwise noted.

| Parameter | | Conditions/Description | Min | Nom | Max | Unit |
|-------------------------------------------------------|-------|-----------------------------------------------------------------------------|------|-----|------------------|----------------------------|
| Output Voltage Setpoint Accuracy | V_o | $V_{i\text{ nom}}, I_o = 3.0\text{ A}, 25\text{ }^\circ\text{C}$ | 3.26 | 3.3 | 3.34 | V |
| Output Current | I_o | $V_{i\text{ min}} - V_{i\text{ max}}$ | 0 | | 6.0 | A |
| Line Regulation | | $V_{i\text{ min}} - V_{i\text{ max}}, 50\% I_{o\text{ max}}$ | | | 65 | mV |
| Load Regulation | | $V_{i\text{ nom}}, I_{o\text{ min}} - I_{o\text{ max}}$ | | | 65 | mV |
| Dynamic Regulation Peak Deviation Settling Time | | 50 – 100% $I_{o\text{ max}}$ load step change. to 1% error band | | | ± 150 500 | mV μs |
| Output Voltage Ripple ¹ | | $V_{i\text{ min}} - V_{i\text{ max}}, I_{o\text{ max}}$ 20 MHz Bandwidth | | 75 | 100 | mV _{pp} |
| Admissible Load Capacitance | | $I_{o\text{ max}}, V_{i\text{ nom}}$ | | | 2200 | μF |
| Output Current Limit Threshold | | $V_o \leq 0.90 V_{o\text{ nom}}$ | 120 | | 200 | % $I_{o\text{ max}}$ |
| Switching Frequency | | $V_{i\text{ nom}}, I_{o\text{ max}}$ | | 220 | | kHz |
| Temperature Coefficient | | | | | 0.02 | % V_o / $^\circ\text{C}$ |
| Trim Range | | $I_{o\text{ min}} - I_{o\text{ max}}, V_{i\text{ min}} - V_{i\text{ max}}$ | 2.97 | | 3.63 | V |

¹ Measured with a 1 μF capacitor across the output pins.

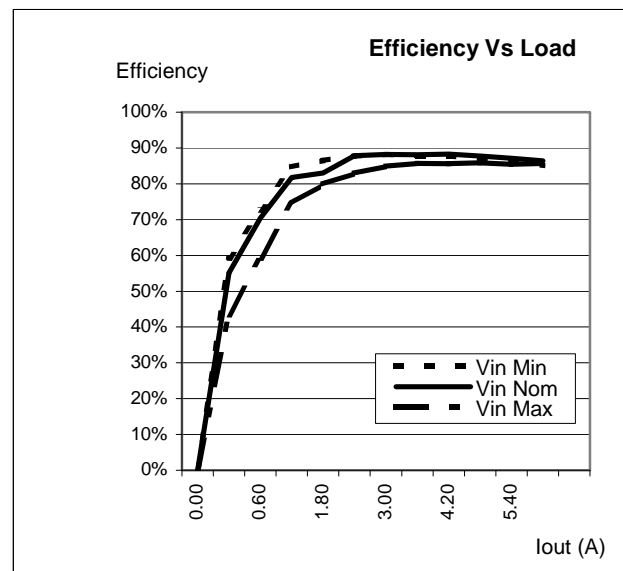
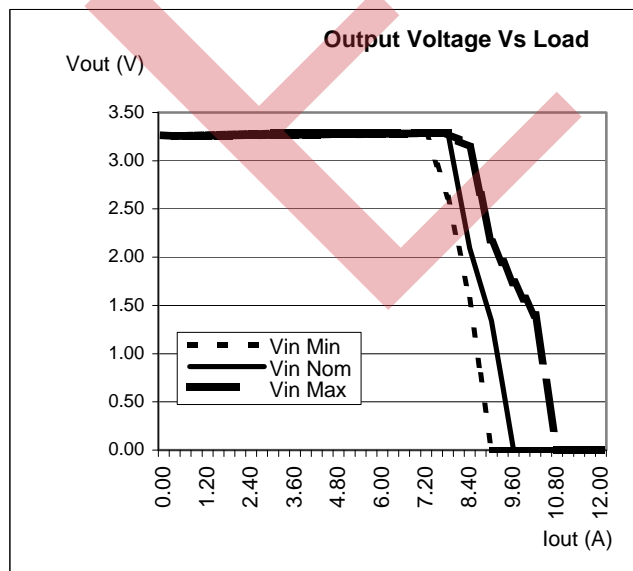
Typical Characteristic Curves

RDS05ZE: 3.3 V / 5.0 A

All specifications apply over input voltage, output load and temperature range, unless otherwise noted.

| Parameter | | Conditions/Description | Min | Nom | Max | Unit |
|-----------------------------------|-------|-----------------------------------------------------------------------------|------|-----|------|----------------------|
| Output Voltage Setpoint Accuracy | V_o | $V_{i\text{ nom}}, I_o = 3.0\text{ A}, 25\text{ }^\circ\text{C}$ | 3.26 | 3.3 | 3.34 | V |
| Output Current | I_o | $V_{i\text{ min}} - V_{i\text{ max}}$ | 0 | | 5.0 | A |
| Line Regulation | | $V_{i\text{ min}} - V_{i\text{ max}}, 50\% I_{o\text{ max}}$ | | | 65 | mV |
| Load Regulation | | $V_{i\text{ nom}}, I_{o\text{ min}} - I_{o\text{ max}}$ | | | 65 | mV |
| Dynamic Regulation Peak Deviation | | 50 – 100% $I_{o\text{ max}}$ load step change. to 1% error band | | | ±150 | mV |
| Settling Time | | | | | 500 | µs |
| Output Voltage Ripple | | $V_{i\text{ min}} - V_{i\text{ max}}, I_{o\text{ max}}$ 20 MHz Bandwidth | | 75 | 100 | mV _{pp} |
| Admissible Load Capacitance | | $I_{o\text{ max}}, V_{i\text{ nom}}$ | | | 2200 | µF |
| Output Current Limit Threshold | | $V_o \leq 0.90 V_{o\text{ nom}}$ | 120 | | 200 | % $I_{o\text{ max}}$ |
| Switching Frequency | | $V_{i\text{ nom}}, I_{o\text{ max}}$ | | 400 | | kHz |
| Temperature Coefficient | | | | | 0.02 | % V_o /°C |
| Trim Range | | $I_{o\text{ min}} - I_{o\text{ max}}, V_{i\text{ min}} - V_{i\text{ max}}$ | 2.97 | | 3.63 | V |

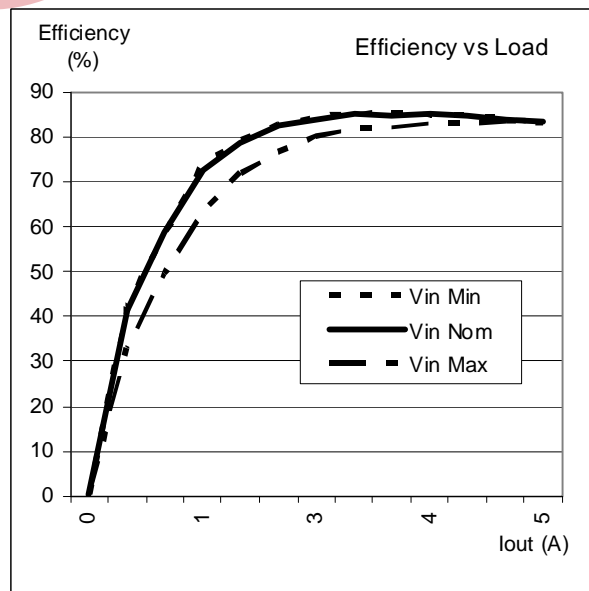
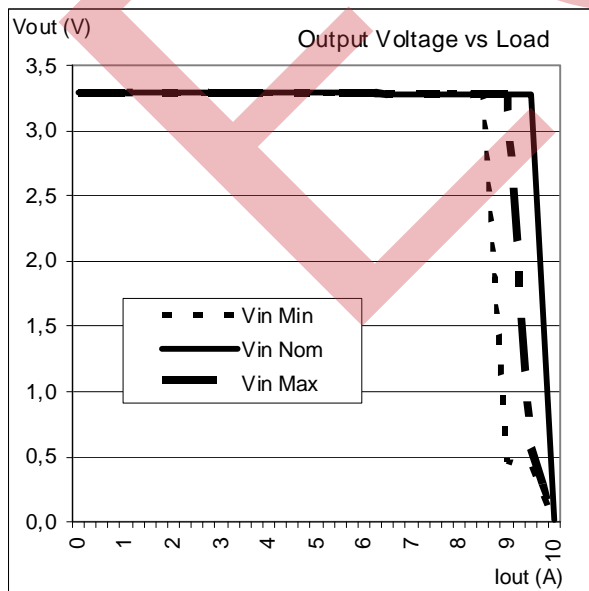
Typical Characteristic Curves

RFS04ZG: 5.0 V / 4.0 A

All specifications apply over input voltage, output load and temperature range, unless otherwise noted.

| Parameter | | Conditions/Description | Min | Nom | Max | Unit |
|------------------------------------|-------|-----------------------------------------------------------------------------|------|-----|------|----------------------|
| Output Voltage Setpoint Accuracy | V_o | $V_{i\text{ nom}}, I_o = 2.0\text{ A}, 25\text{ }^\circ\text{C}$ | 4.94 | 5.0 | 5.06 | V |
| Output Current | I_o | $V_{i\text{ min}} - V_{i\text{ max}}$ | 0 | | 4.0 | A |
| Line Regulation | | $V_{i\text{ min}} - V_{i\text{ max}}, 50\% I_{o\text{ max}}$ | | | 120 | mV |
| Load Regulation | | $V_{i\text{ nom}}, I_{o\text{ min}} - I_{o\text{ max}}$ | | | 120 | mV |
| Dynamic Regulation Peak Deviation | | 50 – 100% $I_{o\text{ max}}$ load step change. to 1% error band | | | ±250 | mV |
| Settling Time | | | | | 500 | µs |
| Output Voltage Ripple ¹ | | $V_{i\text{ min}} - V_{i\text{ max}}, I_{o\text{ max}}$ 20 MHz Bandwidth | | 50 | 75 | mV _{pp} |
| Admissible Load Capacitance | | $I_{o\text{ max}}, V_{i\text{ nom}}$ | | | 2200 | µF |
| Output Current Limit Threshold | | $V_o \leq 0.90 V_{o\text{ nom}}$ | 120 | | 200 | % $I_{o\text{ max}}$ |
| Switching Frequency | | $V_{i\text{ nom}}, I_{o\text{ max}}$ | | 250 | | kHz |
| temperature Coefficient | | | | | 0.02 | % V_o /°C |
| Trim Range | | $I_{o\text{ min}} - I_{o\text{ max}}, V_{i\text{ min}} - V_{i\text{ max}}$ | 4.5 | | 5.5 | V |

¹ Measured with a 1 µF capacitor across the output pins.

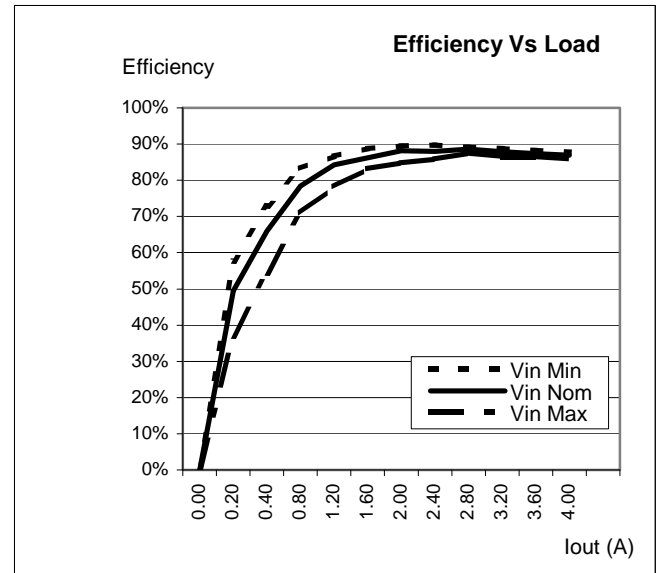
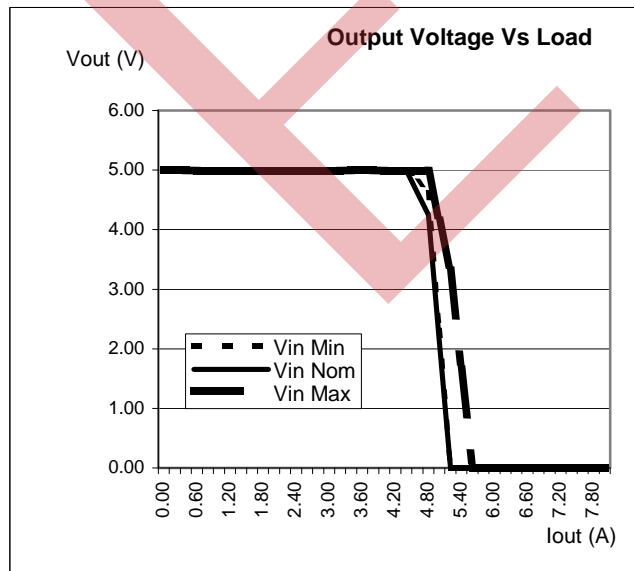
Typical Characteristic Curves

RDS04ZG: 5.0 V/4.0 A

All specifications apply over input voltage, output load and temperature range, unless otherwise noted.

| Parameter | | Conditions/Description | Min | Nom | Max | Unit |
|-----------------------------------|-------|-----------------------------------------------------------------------------|------|-----|------|----------------------|
| Output Voltage Setpoint Accuracy | V_o | $V_{i\text{ nom}}, I_o = 2.0\text{ A}, 25\text{ }^\circ\text{C}$ | 4.94 | 5.0 | 5.06 | V |
| Output Current | I_o | $V_{i\text{ min}} - V_{i\text{ max}}$ | 0 | | 4.0 | A |
| Line Regulation | | $V_{i\text{ min}} - V_{i\text{ max}}, 50\% I_{o\text{ max}}$ | | | 120 | mV |
| Load Regulation | | $V_{i\text{ nom}}, I_{o\text{ min}} - I_{o\text{ max}}$ | | | 120 | mV |
| Dynamic Regulation Peak Deviation | | 50 – 100% $I_{o\text{ max}}$ load step change. to 1% error band | | | ±250 | mV |
| Settling Time | | | | | 500 | µs |
| Output Voltage Ripple | | $V_{i\text{ min}} - V_{i\text{ max}}, I_{o\text{ max}}$ 20 MHz Bandwidth | | 50 | 100 | mV _{pp} |
| Admissible Load Capacitance | | $I_{o\text{ max}}, V_{i\text{ nom}}$ | | | 2200 | µF |
| Output Current Limit Threshold | | $V_o \leq 0.90 V_{o\text{ nom}}$ | 120 | | 200 | % $I_{o\text{ max}}$ |
| Switching Frequency | | $V_{i\text{ nom}}, I_{o\text{ max}}$ | | 400 | | kHz |
| Temperature Coefficient | | | | | 0.02 | % V_o /°C |
| Trim Range | | $I_{o\text{ min}} - I_{o\text{ max}}, V_{i\text{ min}} - V_{i\text{ max}}$ | 4.5 | | 5.5 | V |

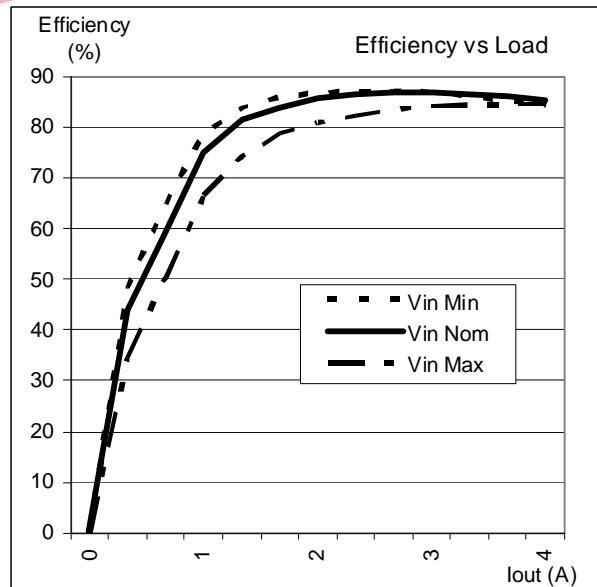
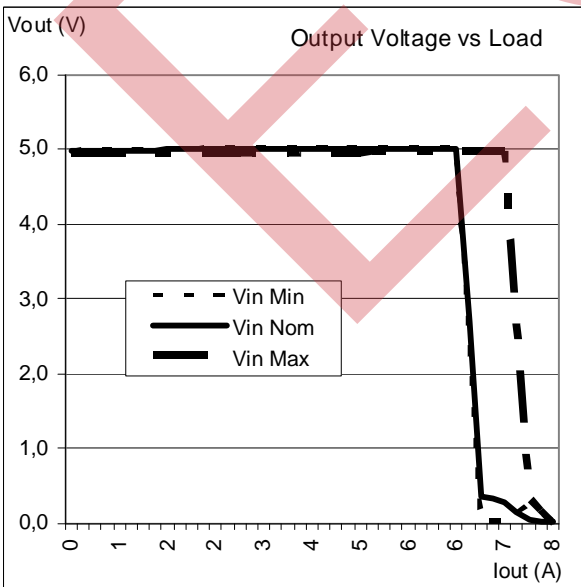
Typical Characteristic Curves

Shutdown

All specifications apply over input voltage, output load, and temperature range, unless otherwise noted.

| Parameter | Conditions/Description | Min | Nom | Max | Unit |
|------------------------------------|----------------------------------------------------------------------|------|-----|------|---------|
| RFS models (pos. logic) | | | | | |
| – Converter ON | Voltage source or open circuit Sink current ($V_i = V_{i,nom}$) | 3.5 | 1.0 | 5.5 | V mA |
| – Converter OFF | Shutdown pin is pulled low | -1.0 | | 1.0 | V |
| RDS models | | | | | |
| Positive logic: | On/Off signal is low – converter OFF | | | | |
| – Converter ON | High logic range | 2.5 | | 5.5 | V |
| – Converter OFF | Shutdown pin is pulled low | -1.0 | | 1.0 | V |
| Negative logic¹: | On/Off signal is low – converter ON | | | | |
| – Converter ON | Low logic range | -1.0 | | 0.25 | V |
| – Converter OFF | Shutdown pin is pulled high | 1.0 | | 5.5 | V |

¹ Prproducts with the suffix **-NM6** or **-NM6G**.

Temperature Derating Curves

The derating curves below give an indication of the output power achievable with and without forced-air cooling. However in the final application, in order to ensure the reliability of the converter, care must be taken to ensure the maximum case temperature is not exceeded under any conditions.

RFS Series:

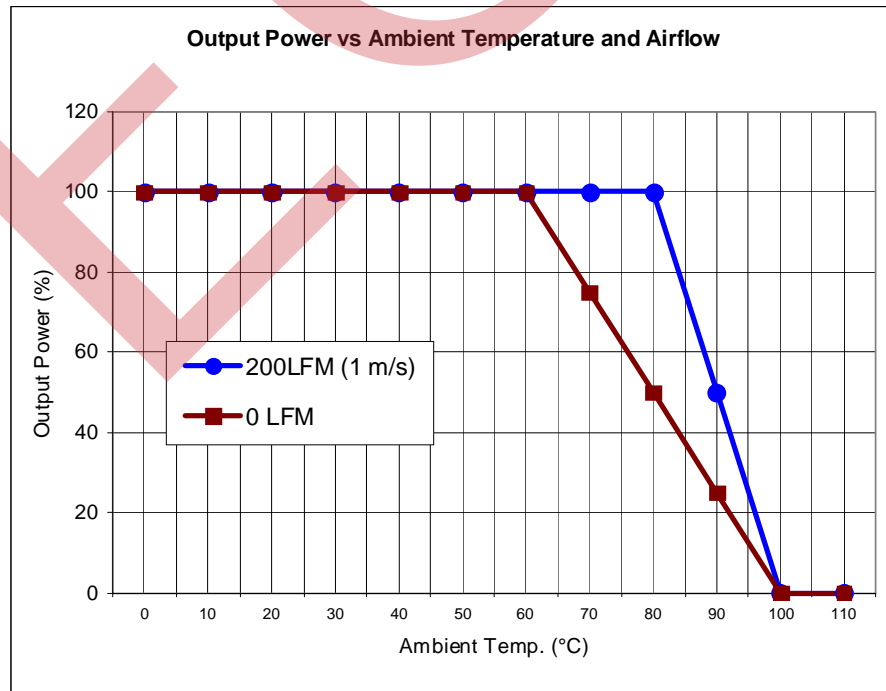

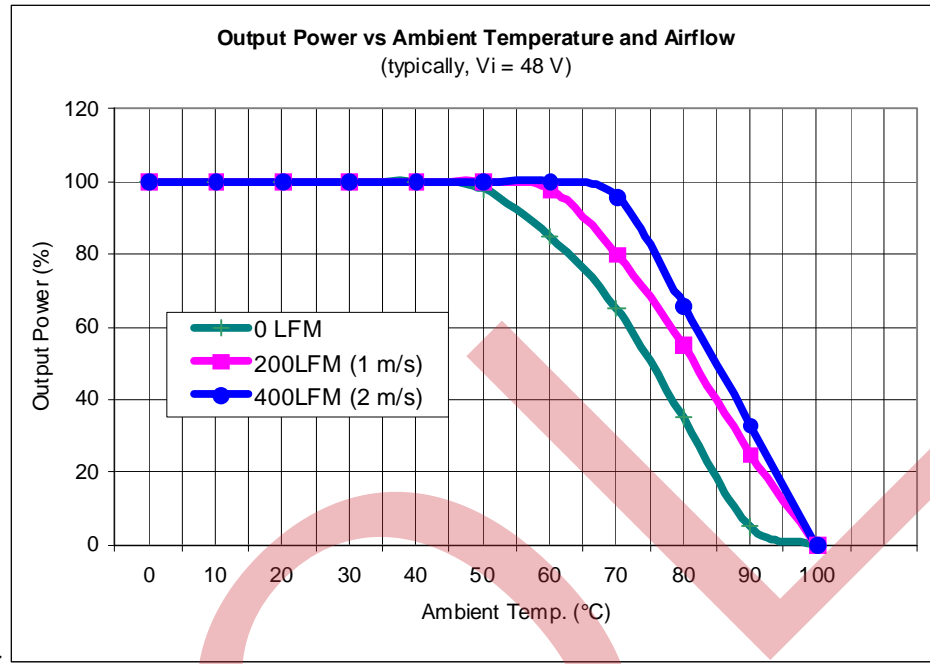
RDS Series:

Application and Auxiliary Functions

These converters do not require any external components for proper operation. However, if the distribution of the input voltage to the converter contains significant inductance, a capacitor across the input terminals may be required to stabilize the input voltage. A minimum of $1\ \mu\text{F}$, quality electrolytic or ceramic capacitor is recommended for this purpose.

For output decoupling it is recommended connecting a $1\ \mu\text{F}$ ceramic capacitor directly across the output pins of the converter.

Shutdown

The remote control pin functions as a normal soft shutdown. It is referenced to the $-V_i$ pin. With positive logic, when the shutdown pin is pulled low, the output is turned off, and the unit goes into a very low input power mode. RDS models are also available with a negative shutdown logic.

An open collector switch is recommended to control the voltage between the shutdown pin and the $-V_i$ pin of the converter. The shutdown pin is pulled up internally, so no external voltage source is required. The user should avoid connecting a resistor between the shutdown pin and $+V_i$ pin.

The user must take care to ensure that the pin reference for the control is connected close to the $-V_i$ pin. The control signal must not be referenced ahead of EMI filtering, or remotely from the converter. If the shutdown pin is not used, it can be left open-circuit.

Negative Logic for RDS (suffix -NM6 or -NM6G)

The output of the converter is enabled or disabled by means of a logic signal (TTL, CMOS, etc.) applied to the shutdown pin. No output voltage overshoot will occur, when the converter is turned on. If the shutdown function is not required, the pin should be connected with $-V_i$ to enable the output.

Thermal Considerations

The converter is designed for natural or forced convection cooling. The output power of the converter is limited by the maximum case temperature (T_c). To ensure reliable long term operation of the converters, and to comply with safety agency requirements, Power-One limits maximum allowable case temperature (T_c) to $100\ ^\circ\text{C}$ (see Mechanical Data).

Output Current Limitation

When the output is overloaded above the maximum output current rating, the voltage will start to reduce to maintain the output power to a safe level. In a condition of high overload or short-circuit where the output voltage is pulled below approximately 30% of $V_{o\ nom}$, the converter will enter a 'hiccup' mode of operation. Under this condition the converter will attempt to restart, approximately every 25 ms, until the overload has cleared.

Parallel Operation

Paralleling of two converters is not possible.

Output Voltage Adjust

This feature allows the user to adjust the output voltage V_o .

Output voltage can be adjusted using an external resistor. To increase V_o , a resistor R_{ext} should be connected between pins 2 and 3. To decrease V_o , the resistor should be connected between pins 1 and 3.

To increase V_o :

$$R_{ext} = (A - (D \times V_o)) / (V_o - V_{o\ nom}) \quad [\Omega]$$

To reduce V_o :

$$R_{ext} = ((B \times V_o) - C) / (V_{o\ nom} - V_o) \quad [\Omega]$$

| Model | A | B | C | D |
|--------------------|-------|------|-------|------|
| RFS06ZA | 1945 | 1470 | 1944 | 470 |
| RFS06ZB RDS06ZB | 2590 | 1730 | 2560 | 750 |
| RFS06ZD | 5010 | 2516 | 5010 | 1500 |
| RFS06ZE RDS05ZE | 7010 | 3161 | 7010 | 1500 |
| RFS04ZG RDS04ZG | 11260 | 4532 | 11240 | 1500 |

Note: When the output voltage is trimmed up, the output power from the converter must not exceed its maximum rating. This is determined by measuring the voltage on the output pins and multiplying it by the output current.

Safety

These converters are tested with 1500 VDC from input to output. The input-to-output resistance is greater than 10 M Ω . These converters are provided with Basic Insulation between input and output. Nevertheless, if the system using the converter needs to receive safety agency approval, certain rules must be followed in the design of the system. In particular, all of the creepage and clearance requirements of the end-use system must be observed.

In order to consider the output of the converter as SELV (Safety Extra Low Voltage) or TNV-1, according to IEC/EN 60950-1 and UL/CSA 60950-1, the following requirements must be met in the system design:

- **Fuse:** As the converter has no internal fuse, an external fuse must be provided to protect the system from catastrophic failure. We recommend a fuse with a rating not greater than 2.0 A. The user can select a fuse with lower rating based upon the maximum inrush transient and the maximum input current at the minimum input voltage. Both input traces and the chassis ground trace (if applicable) must be capable of conducting a current of 1.5 times the value of the fuse without opening. The fuse must not be placed in the grounded input line.
- If the voltage source feeding the converter is SELV, TNV-1, or TNV-2, the output of the converter is considered SELV and may be grounded or ungrounded.
- The circuitry of the converter may generate transients, which exceed the input voltage. Even if the input voltage is SELV (<60 V), the components on the primary side of the converter may have to be considered as hazardous. A safety interlock may be needed to prevent the user from accessing the converter while operational.

EMC Specifications

Conducted Noise, RFS Series

The converters meet the requirements of EN 55022 Class A and Class B for conducted noise on the input terminals using the circuit below:

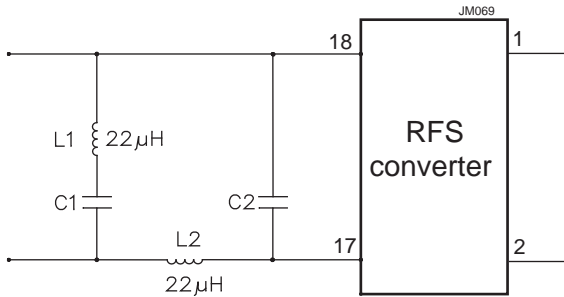

C1 = 18 nF for RFS04ZG, RFS06ZE
C1 = 27 nF for RFS06ZD, RFS06ZB, RFS06ZA

C2 = 2 μF to meet EN 55022 Class **A**
C2 = 7 μF to meet EN 55022 Class **B**

Conducted Noise, RDS Series

The converters may require a single capacitor to meet the requirements of EN 55022 Class A for conducted emissions on the input terminals; see the figure below.

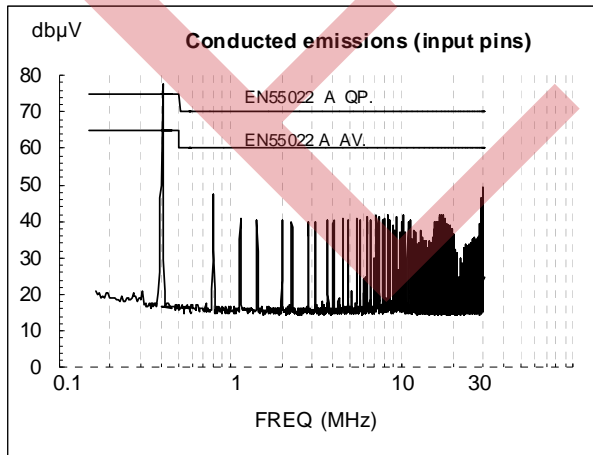

Electromagnetic Susceptibility:

| Standard | Applied Stress | Class Level | Performance Criterion * |
|--------------------------------------------|------------------|-------------|-------------------------|
| Electrostatic Discharge EN 61000-4-2 | 2 kV to pins | 1 | B |
| Electromagnetic Field EN 61000-4-3 | 3 V/m | 2 | A |
| Electrical Fast Transients EN 61000-4-4 | 2000 Vp to input | 3 | B |
| Conducted Disturbances EN 61000-4-6 | 3 VAC to input | 2 | B |

* **A** denotes normal operation, no deviation from specification. **B** denotes temporary deviation from specification possible.

Mechanical Data

Dimensions in mm [inches]

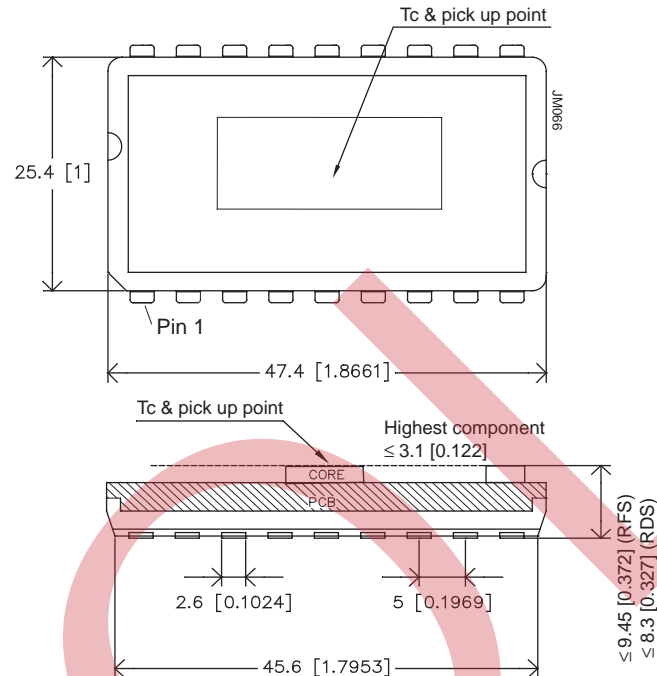

Surface Mount Assembly

Soldering

The following soldering instructions must be observed to prevent failure or significant degradation of the converter performance. Power-One will not honor any warranty claims arising from failure to observe these instructions.

The lead-frame is constructed for a high temperature glass filled, UL94 V-0 flame retardant, dually orthophthalate molding compound commonly used for packaging of electronics components. It has passed NASA outgassing tests, and is certified to MIL-M-14. The coefficient of thermal expansion is equivalent to FR4.

The gull wing leads are formed to ensure optimal solder joint strength and structure. Furthermore they facilitate visual inspection (manual or automatic). The leads are formed from a 97% Cu alloy plated with Ni and matte Sn. This material is commonly used in

the manufacture of integrated circuits. It has good corrosion resistance and exhibits the nobility inherent to all high copper alloys. Unlike brasses, this material is essentially immune to stress corrosion cracking. It also exhibits excellent solderability. It is readily wetted by solders and performs well in standard solderability tests. (Dip of Class II or better).

The product is manufactured with a patented process, which is fully automated and 'in-line'. This ensures that there is no contamination or mechanical stress on the lead-frame so that the co-planarity and solderability are maintained.

The product is shipped in JEDEC trays to ensure preservation of the co-planarity and enable fully automated assembly in the final application. Mind the marking for pin 1!

These products are approved for forced convection reflow soldering only. Products RoHS-compliant for all 6 substances (model designation ending with G) allow for a solder profile with higher temperatures; see tables below.

Recommended Reflow Profile (measured at the leads of the converter)

| Product | Pre-heat ramp | | | Pre-heat soaking | | | Ramp to reflow | Reflow | | | | Cooling |
|--------------------------------|---------------|----------|--------------|------------------|----------|-----------|----------------|--------------------------|------------------|--------------------------------------|-------------------|--------------|
| | From °C | To °C | Rate °C/s | From °C | To °C | Time s | Rate °C | Time above liquidus s | Peak temp. °C | Time within ±5 °C of peak temp. s | Time to peak s | Rate °C/s |
| -M6 (Sn-Pb eutectic) | 25 | 150 | 2 | 150 | 183 | 90 - 120 | 2 | 45 | 220 ±5 | 10 | 180 | 3 |
| -M6G (lead-free) | 25 | 180 | 2 | 180 | 217 | 90 - 120 | 2 | 45 | 240 ±5 | 10 | 210 | 3 |

Worst Case Reflow Parameters Following J-STD-020D (measured in the center, on top side of the converter)

| Product | Pre-heat ramp | | | Pre-heat soaking | | | Ramp to reflow | Reflow | | | | Cooling |
|--------------------------------|---------------|----------|--------------|------------------|----------|----------------|----------------|-------------------------------|-----------------------|-------------------------------------------|------------------------|--------------|
| | From °C | To °C | Rate °C/s | From °C | To °C | Max. time s | Rate °C | Max. time above liquidus s | Max. peak temp. °C | Max. time within ±5 °C of peak temp. s | Max. time to peak s | Rate °C/s |
| -M6 (Sn-Pb eutectic) | 25 | 150 | 3 | 100 | 150 | 120 | 3 | 45 | 230 | 10 | 360 | 6 |
| -M6G (lead-free) | 25 | 180 | 3 | 150 | 200 | 120 | 3 | 45 | 260 | 10 | 480 | 6 |

Pick & Place Assembly

The product is designed with a large flat area in the center of the top surface to serve as a pick up point for automated vacuum pick and place equipment. The 'open board' construction of the unit ensures that weight is kept to a minimum. However due to the relatively large size of the component, a large nozzle (>8 mm, depending on vacuum pressure) is recommended for picking and placing.

The unit may also be automatically handled using 'odd-form' placement equipment, with mechanical grippers. For this type of equipment the end edges of the device, which have no leads and also feature the greatest dimensional accuracy, should be used as pick-up points.

Recommended Solder Lands

Dimensions in mm [inches]

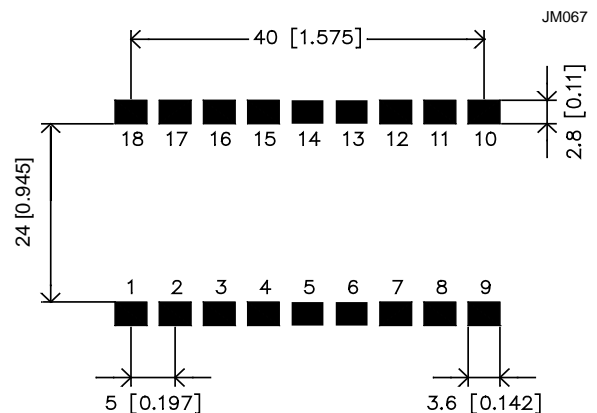

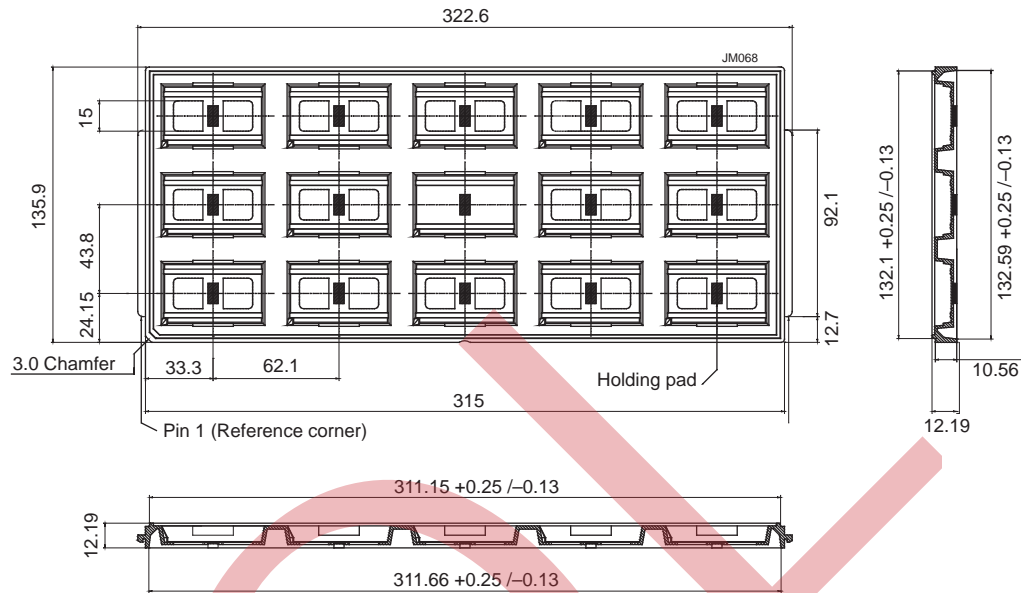
JEDEC Tray

Pinout

| Pin | Designation | Function | Reference |
|-----|-------------|---------------------------------------------|-----------|
| 1 | +Vo | Positive output voltage | Secondary |
| 2 | -Vo | Output voltage return | Secondary |
| 3 | Trim | Output voltage adjust | Secondary |
| 4 | NC | No connection | Secondary |
| 5 | NC | No connection | Primary |
| 6 | NC | No connection | Primary |
| 7 | NC | No connection | Primary |
| 8 | NC | No connection | Primary |
| 9 | NC | No connection | Primary |
| 10 | NC | No connection | Primary |
| 11 | Shutdown | Shutdown control. Pull low to turn unit off | Primary |
| 12 | NC | No connection | Primary |
| 13 | NC | No connection | Primary |
| 14 | NC | No connection | Primary |
| 15 | NC | No connection | Primary |
| 16 | NC | No connection | Primary |
| 17 | -Vi | Input voltage return | Primary |
| 18 | +Vi | Positive input voltage | Primary |

NUCLEAR AND MEDICAL APPLICATIONS - Bel Power Solutions products are not designed, intended for use in, or authorized for use as critical components in life support systems, equipment used in hazardous environments, or nuclear control systems without the express written consent of the respective divisional president of Bel Power Solutions.

TECHNICAL REVISIONS - The appearance of products, including safety agency certifications pictured on labels, may change depending on the date manufactured. Specifications are subject to change without notice.