

LW025 Single-Output-Series Power Modules: 36 Vdc to 75 Vdc Inputs; 25 W



The LW025 Single-Output-Series Power Modules use advanced, surface-mount technology and deliver high-quality, compact, dc-dc conversion at an economical price.

Options

- Choice of on/off configuration
- Case ground pin
- Synchronization
- Short pins: 2.79 mm ± 0.25 mm
(0.110 in. ± 0.010 in.)
- Short pins: 3.68 mm ± 0.25 mm
(0.145 in. ± 0.010 in.)

Description

The LW025 Single-Output-Series Power Modules are low-profile dc-dc converters that operate over an input voltage range of 36 Vdc to 75 Vdc and provide precisely regulated outputs. The output is isolated from the input, allowing versatile polarity configurations and grounding connections. The module has a maximum power rating of 25 W at a typical full-load efficiency of 79%.

The power modules feature remote on/off and output voltage adjustments of 90% to 110% of the nominal output voltage. Built-in filtering for both input and output minimizes the need for external filtering.

* *UL* is a registered trademark of Underwriters Laboratories, Inc.

† *CSA* is a registered trademark of Canadian Standards Association.

‡ This product is intended for integration into end-use equipment. All the required procedures for CE marking of end-use equipment should be followed. (The CE mark is placed on selected products.)

Features

- Low profile: 9.91 mm (0.390 in.) with 0.38 mm (0.015 in.) standoffs, 9.53 mm (0.375 in.) with standoffs recessed
- Wide input voltage range: 36 Vdc to 75 Vdc
- Input-to-output isolation
- Operating case temperature range: -40 °C to +110 °C
- Metal case
- Overcurrent protection
- Remote on/off
- Output voltage adjust: 90% to 110% of $V_{O, nom}$
- Output overvoltage protection
- *UL** 1950 Recognized, *CSA*† C22.2 No. 950-95 Certified, VDE 0805 (EN60950, IEC950) Licensed
- CE mark meets 73/23/EEC and 93/68/EEC directives‡
- Within FCC and EN55022 (CISPR 22) Class A radiated limits

Applications

- Distributed power architectures
- Telecommunications

Absolute Maximum Ratings

Stresses in excess of the absolute maximum ratings can cause permanent damage to the devices. These are absolute stress ratings only. Functional operation of the devices is not implied at these or any other conditions in excess of those given in the operations sections of the data sheet. Exposure to absolute maximum ratings for extended periods can adversely affect device reliability.

Parameter	Symbol	Min	Max	Unit
Input Voltage: Continuous	V_I	0	80	Vdc
Transient (100 ms)	$V_{I, trans}$	0	100	V
Operating Case Temperature (See Figure 16.)	T_C	-40	110*	°C
Storage Temperature	T_{stg}	-40	120	°C
I/O Isolation Voltage	—	—	1500	Vdc

* Maximum case temperature varies based on power dissipation. See derating curves, Figures 15—16, for details.

Electrical Specifications

Unless otherwise indicated, specifications apply over all operating input voltage, resistive load, and temperature conditions.

Table 1. Input Specifications

Parameter	Symbol	Min	Typ	Max	Unit
Operating Input Voltage	V_I	36	48	75	Vdc
Maximum Input Current ($V_I = 0$ V to $V_{I, max}$; $I_O = I_{O, max}$; see Figures 1 and 2.)	$I_{I, max}$	—	—	1.2	A
Inrush Transient	i^2t	—	—	0.1	A ² s
Input Reflected-ripple Current (50 Hz to 20 MHz; 12 μ H source impedance, $T_C = 25$ °C; see Figure 10.)	I_I	—	3	—	mAp-p
Input Ripple Rejection (100 Hz—120 Hz)	—	—	60	—	dB

Fusing Considerations

CAUTION: This power module is not internally fused. An input line fuse must always be used.

This encapsulated power module can be used in a wide variety of applications, ranging from simple stand-alone operation to an integrated part of a sophisticated power architecture. To preserve maximum flexibility, internal fusing is not included; however, to achieve maximum safety and system protection, always use an input line fuse. The safety agencies require a normal-blow fuse with a maximum rating of 5 A (see Safety Considerations section). Based on the information provided in this data sheet on inrush energy and maximum dc input current, the same type of fuse with a lower rating can be used. Refer to the fuse manufacturer's data for further information.

Electrical Specifications (continued)

Table 2. Output Specifications

Parameter	Device	Symbol	Min	Typ	Max	Unit
Output Voltage Set Point ($V_I = 48\text{ V}$; $I_O = I_{O, \text{max}}$; $T_C = 25\text{ }^\circ\text{C}$)	LW025F	$V_{O, \text{set}}$	3.25	3.3	3.35	Vdc
	LW025A	$V_{O, \text{set}}$	4.92	5.0	5.08	Vdc
Output Voltage (Over all line, load, and temperature conditions until end of life; see Figure 12.)	LW025F	V_O	3.17	—	3.43	Vdc
	LW025A	V_O	4.85	—	5.15	Vdc
Output Regulation: Line ($V_I = 36\text{ V to }75\text{ V}$) Load ($I_O = I_{O, \text{min}}$ to $I_{O, \text{max}}$) Temperature ($T_C = -40\text{ }^\circ\text{C to }+100\text{ }^\circ\text{C}$)	All	—	—	0.01	0.1	% V_O
	All	—	—	0.05	0.4	% V_O
	All	—	—	0.5	1.0	% V_O
Output Ripple and Noise (See Figure 11.): RMS Peak-to-peak (5 Hz to 20 MHz)	All	—	—	—	40	mVrms
	All	—	—	20	100	mVp-p
Output Current (At $I_O < I_{O, \text{min}}$, the modules may exceed output ripple specifications.)	All	I_O	0.4	—	5.0	A
Output Current-limit Inception ($V_O = 90\% \times V_{O, \text{set}}$; see Figures 3 and 4.)	All	I_O	103	—	150	% $I_{O, \text{max}}$
Output Short-circuit Current ($V_O = 250\text{ mV}$)	All	I_O	—	135	200	% $I_{O, \text{max}}$
Efficiency ($V_I = V_{I, \text{nom}}$; $I_O = I_{O, \text{max}}$; $T_C = 25\text{ }^\circ\text{C}$; see Figures 5, 6, and 12.)	LW025F	η	75	77	—	%
	LW025A	η	77	79	—	%
Switching Frequency	All	—	—	256	—	kHz
Dynamic Response ($\Delta I_O/\Delta t = 1\text{ A}/10\text{ }\mu\text{s}$, $V_I = V_{I, \text{nom}}$, $T_A = 25\text{ }^\circ\text{C}$): Load Change from $I_O = 50\%$ to 75% of $I_{O, \text{max}}$: Peak Deviation Settling Time ($V_O < 10\%$ peak deviation) Load Change from $I_O = 50\%$ to 25% of $I_{O, \text{max}}$: Peak Deviation Settling Time ($V_O < 10\%$ peak deviation)	All	—	—	1	—	% $V_{O, \text{set}}$
	All	—	—	0.5	—	ms
	All	—	—	1	—	% $V_{O, \text{set}}$
	All	—	—	0.5	—	ms

Table 3. Isolation Specifications

Parameter	Min	Typ	Max	Unit
Isolation Capacitance	—	0.002	—	μF
Isolation Resistance	10	—	—	$\text{M}\Omega$

General Specifications

Parameter	Min	Typ	Max	Unit
Calculated MTBF ($I_O = 80\%$ of $I_{O, \text{max}}$; $T_C = 40\text{ }^\circ\text{C}$)	5,500,000			hours
Weight	—	—	54 (1.9)	g (oz.)

Feature Specifications

Unless otherwise indicated, specifications apply over all operating input voltage, resistive load, and temperature conditions. See Feature Descriptions and Design Considerations for further information.

Parameter	Device	Symbol	Min	Typ	Max	Unit
<p>Remote On/Off Signal Interface: ($V_I = 0\text{ V}$ to $V_{I, \text{max}}$; open collector or equivalent compatible; signal referenced to $V_I(-)$ terminal. See Figure 13 and Feature Descriptions.):</p> <p>Negative Logic: Device Code Suffix "1": Logic Low—Module On Logic High—Module Off</p> <p>Positive Logic: If Device Code Suffix "1" Is Not Specified: Logic Low—Module Off Logic High—Module On</p> <p>Module Specifications:</p> <p>On/Off Current: Logic Low</p> <p>On/Off Voltage: Logic Low Logic High ($I_{\text{on/off}} = 0$)</p> <p>Open Collector Switch Specifications: Leakage Current During Logic High ($V_{\text{on/off}} = 10\text{ V}$) Output Low Voltage During Logic Low ($I_{\text{on/off}} = 1\text{ mA}$)</p>	All	$I_{\text{on/off}}$	—	—	1.0	mA
	All	$V_{\text{on/off}}$	-0.7	—	1.2	V
	All	$V_{\text{on/off}}$	—	—	10	V
	All	$I_{\text{on/off}}$	—	—	50	μA
	All	$V_{\text{on/off}}$	—	—	1.2	V
<p>Turn-on Delay and Rise Times (at 80% of $I_{O, \text{max}}$; $T_A = 25\text{ }^\circ\text{C}$):</p> <p>Case 1: On/Off Input Is Set for Unit On and Then Input Power Is Applied (delay from point at which $V_I = 48\text{ V}$ until $V_O = 10\%$ of $V_{O, \text{nom}}$).</p> <p>Case 2: 48 V Input Is Applied for at Least One Second, and Then the On/Off Input Is Set to Turn the Module On (delay from point at which on/off input is toggled until $V_O = 10\%$ of $V_{O, \text{nom}}$).</p> <p>Output Voltage Rise Time (time for V_O to rise from 10% of $V_{O, \text{nom}}$ to 90% of $V_{O, \text{nom}}$)</p> <p>Output Voltage Overshoot (at 80% of $I_{O, \text{max}}$; $T_A = 25\text{ }^\circ\text{C}$)</p>	All	T_{delay}	—	27	50	ms
	All	T_{delay}	—	2	10	ms
	All	T_{rise}	—	1.5	3.0	ms
	All	—	—	—	5	%
Output Voltage Set-point Adjustment Range	All	—	90	—	110	% $V_{O, \text{nom}}$
Output Overvoltage Protection (clamp)	LW025F	$V_{O, \text{clamp}}$	3.9	—	5.0	V
	LW025A	$V_{O, \text{clamp}}$	5.6	—	7.0	V

Characteristics Curves

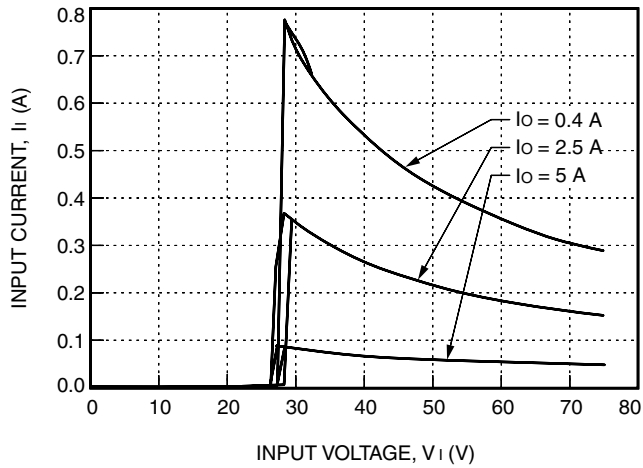

8-2233(C)

Figure 1. LW025F Typical Input Characteristics

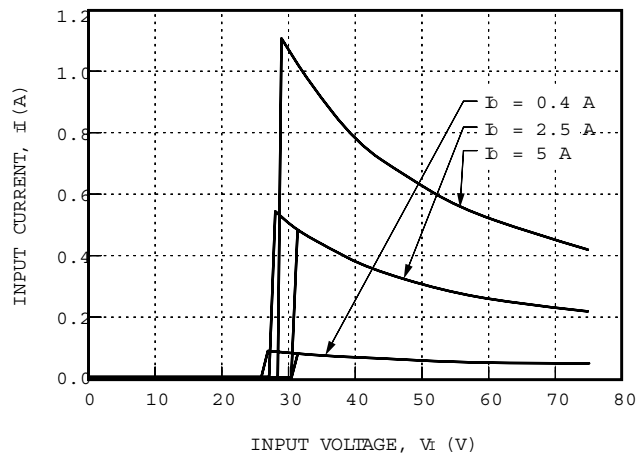

8-1982(C).b

Figure 2. LW025A Typical Input Characteristics

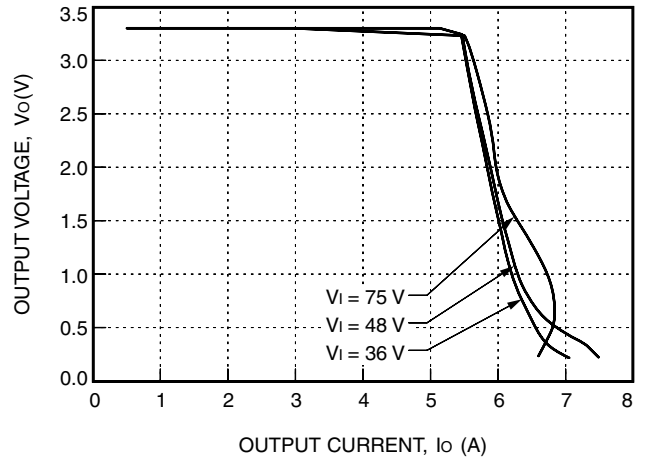

8-2234(C)

Figure 3. LW025F Typical Output Characteristics

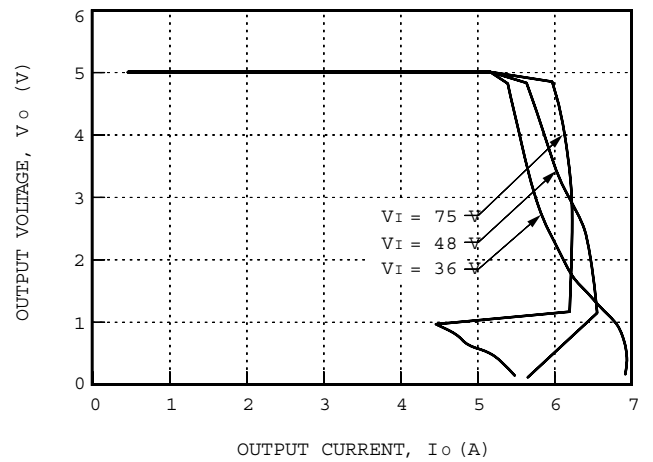

8-1983(C)

Figure 4. LW025A Typical Output Characteristics

Characteristics Curves (continued)

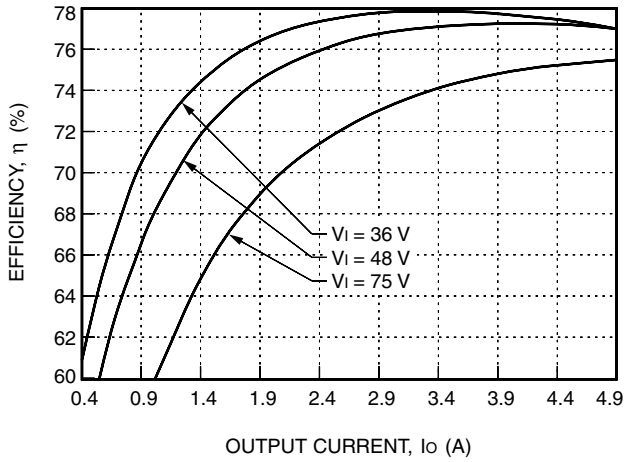

8-2478(C)

Figure 5. LW025F Typical Converter Efficiency vs. Output Current

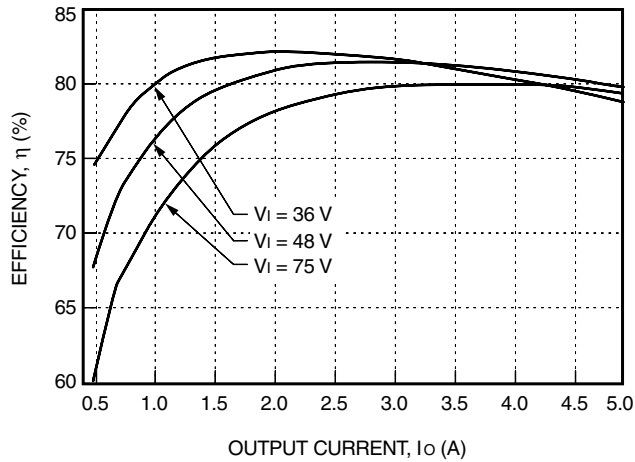

8-1984(C)

Figure 6. LW025A Typical Converter Efficiency vs. Output Current

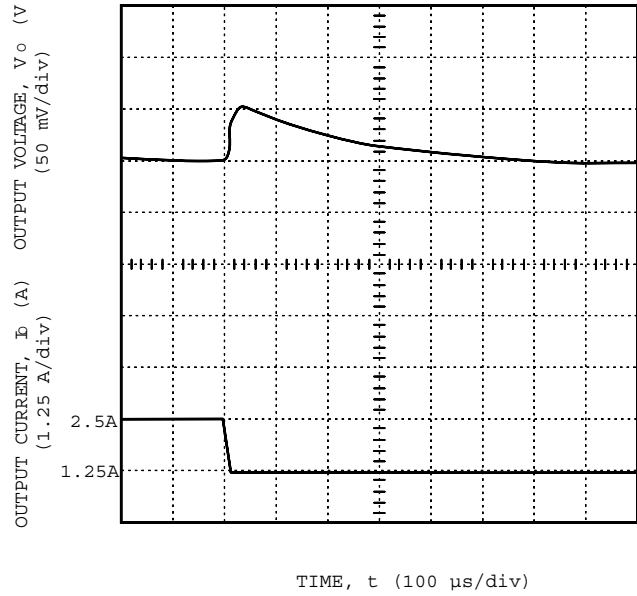

8-1261(C).c

Figure 7. LW025A, F Typical Output Voltage for a Step Load Change from 50% to 25%

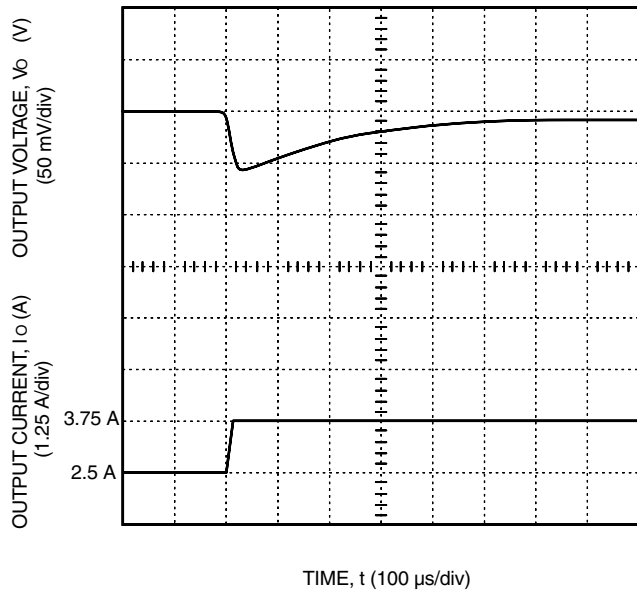

8-1262(C)

Figure 8. LW025A, F Typical Output Voltage for a Step Load Change from 50% to 75%

Characteristics Curves (continued)

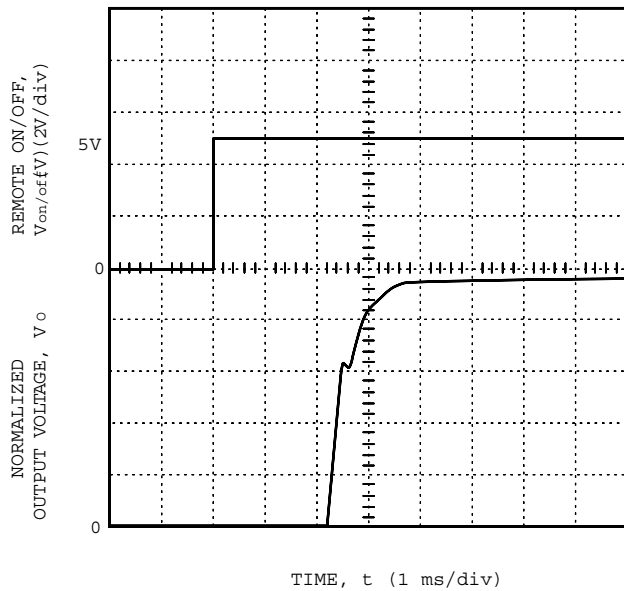
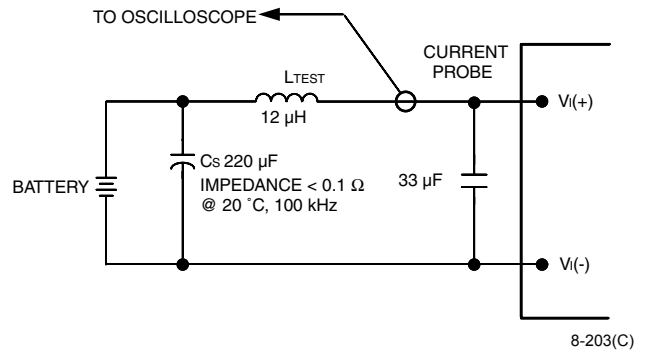

Figure 9. LW025A, F Typical Output Voltage Start-Up when Signal Is Applied to Remote On/Off

8-1263(C).e

Test Configurations



Note: Input reflected-ripple current is measured with a simulated source impedance of 12 μH. Capacitor C_s offsets possible battery impedance. Current is measured at the input of the module.

Figure 10. Input Reflected-Ripple Test Setup

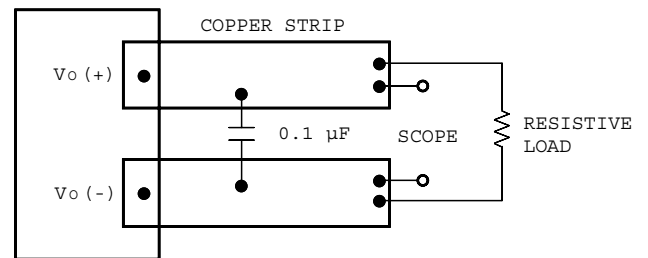

Note: Use a 0.1 μF ceramic capacitor. Scope measurement should be made using a BNC socket. Position the load between 50 mm and 75 mm (2 in. and 3 in.) from the module.

Figure 11. Peak-to-Peak Output Noise Measurement Test Setup

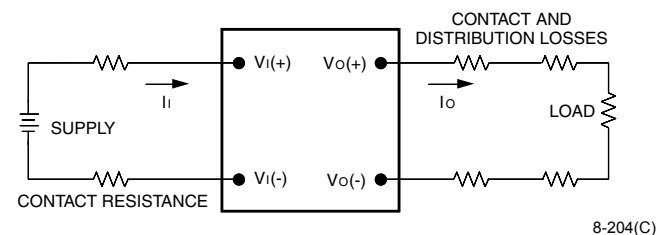

Note: All measurements are taken at the module terminals. When socketing, place Kelvin connections at module terminals to avoid measurement errors due to socket contact resistance.

$$\eta = \left(\frac{[V_o(+)-V_o(-)]I_o}{[V_i(+)-V_i(-)]I_i} \right) \times 100 \quad \%$$

Figure 12. Output Voltage and Efficiency Measurement Test Setup

Design Considerations

Grounding Considerations

For modules without the isolated case ground pin option, the case is internally connected to the $V_I(+)$ pin. For modules with the isolated case ground pin, device code suffix "7," the $V_I(+)$ pin is not connected to the case.

Input Source Impedance

The power module should be connected to a low ac-impedance input source. Highly inductive source impedances can affect the stability of the power module. For the test configuration in Figure 10, a 33 μ F electrolytic capacitor (ESR < 0.7 $\frac{3}{4}$ at 100 kHz) mounted close to the power module helps ensure stability of the unit. For other highly inductive source impedances, consult the factory for further application guidelines.

Safety Considerations

For safety-agency approval of the system in which the power module is used, the power module must be installed in compliance with the spacing and separation requirements of the end-use safety agency standard, i.e., *UL* 1950, *CSA* C22.2 No. 950-95, and *VDE* 0805 (EN60950, IEC950).

If the input source is non-SELV (ELV or a hazardous voltage greater than 60 Vdc and less than or equal to 75 Vdc), for the module's output to be considered meeting the requirements of safety extra-low voltage (SELV), all of the following must be true:

- n The input source is to be provided with reinforced insulation from any other hazardous voltages, including the ac mains; and
- n One V_I pin and one V_O pin are to be grounded or both the input and output pins are to be kept floating; and
- n The input pins of the module are not operator accessible; and
- n Another SELV reliability test is conducted on the whole system, as required by the safety agencies, on the combination of supply source and the subject module to verify that under a single fault, hazardous voltages do not appear at the module's output.

Note: Do not ground either of the input pins of the module without grounding one of the output pins. This may allow a non-SELV voltage to appear between the output pins and ground.

The power module has extra-low voltage (ELV) outputs when all inputs are ELV.

The input to these units is to be provided with a maximum 5 A normal-blow fuse in the ungrounded lead.

Feature Descriptions

Overcurrent Protection

To provide protection in a fault (output overload) condition, the unit is equipped with internal current-limiting circuitry and can endure current limiting for an unlimited duration. At the point of current-limit inception, the unit shifts from voltage control to current control. If the output voltage is pulled very low during a severe fault, the current-limit circuit can exhibit either foldback or tailout characteristics (output-current decrease or increase). The unit operates normally once the output current is brought back into its specified range.

Remote On/Off

Two remote on/off options are available. Positive logic remote on/off turns the module on during a logic-high voltage on the REMOTE ON/OFF pin, and off during a logic low. Negative logic, device code suffix "1," remote on/off turns the module off during a logic high and on during a logic low.

To turn the power module on and off, the user must supply a switch to control the voltage between the on/off terminal and the $V_I(-)$ terminal ($V_{on/off}$). The switch can be an open collector or equivalent (see Figure 13). A logic low is $V_{on/off} = -0.7$ V to 1.2 V. The maximum $I_{on/off}$ during a logic low is 1 mA. The switch should maintain a logic-low voltage while sinking 1 mA.

During a logic high, the maximum $V_{on/off}$ generated by the power module is 6 V. The maximum allowable leakage current of the switch at $V_{on/off} = 6$ V is 50 μ A.

The module has internal capacitance to reduce noise at the ON/OFF pin. Additional capacitance is not generally needed and may degrade the start-up characteristics of the module.

Feature Descriptions (continued)

Remote On/Off (continued)

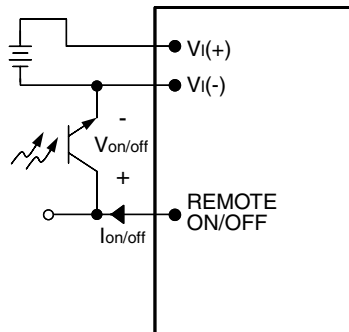

8-758(C).a

Figure 13. Remote On/Off Implementation

Output Voltage Adjustment

Output voltage trim allows the user to increase or decrease the output voltage set point of a module. This is accomplished by connecting an external resistor between the TRIM pin and either the $V_{O(+)}$ or $V_{O(-)}$ pins. With an external resistor between the TRIM and $V_{O(+)}$ pins ($R_{adj-down}$), the output voltage set point ($V_{O, adj}$) decreases. With an external resistor between the TRIM pin and $V_{O(-)}$ pin (R_{adj-up}), $V_{O, adj}$ increases.

The following equations determine the required external resistor value to obtain an output voltage change of $\Delta\%$:

$$R_{adj-down} = \left[\frac{c[d \cdot (1 - \Delta\%) - 1]}{\Delta\%} - b \right] k\Omega$$

$$R_{adj-up} = \left[\frac{a}{d \cdot \Delta\%} - b \right] k\Omega$$

Device	a	b	c	d	-5% V_O $R_{adj-down}$	+5% V_O R_{adj-up}
LW025F	14.0	51.1	5.2	2.7	111.7 $k\frac{3}{4}$	52.7 $k\frac{3}{4}$
LW025A	4.02	16.9	2.01	2.0	19.3 $k\frac{3}{4}$	23.3 $k\frac{3}{4}$

The adjusted output voltage cannot exceed 110% of the nominal output voltage between the $V_{O(+)}$ and $V_{O(-)}$ terminal.

The modules have a fixed current-limit set point. Therefore, as the output voltage is adjusted down, the available output power is reduced. In addition, the minimum output current is a function of the output voltage. As the output voltage is adjusted down, the minimum required output current can increase.

Output Overvoltage Protection

The output overvoltage clamp consists of control circuitry, independent of the primary regulation loop, that monitors the voltage on the output terminals. The control loop of the protection circuit has a higher voltage set point than the primary loop (see Feature Specifications table). In a fault condition, the overvoltage clamp ensures that the output voltage does not exceed $V_{O, clamp, max}$. This provides a redundant voltage-control that reduces the risk of output overvoltage.

Feature Descriptions (continued)

Synchronization (Optional)

The unit is capable of external synchronization from an independent time base with a switching rate of 256 kHz. The amplitude of the synchronizing pulse train is TTL compatible and the duty cycle ranges between 40% and 60%. Synchronization is referenced to $V_I(+)$.

Thermal Considerations

Introduction

The LW025 Single-Output-Series Power Modules operate in a variety of thermal environments; however, sufficient cooling should be provided to help ensure reliable operation of the unit. Heat-dissipating components inside the unit are thermally coupled to the case. Heat is removed by conduction, convection, and radiation to the surrounding environment. Proper cooling can be verified by measuring the case temperature. Peak case temperature (T_C) occurs at the position indicated in Figure 14.

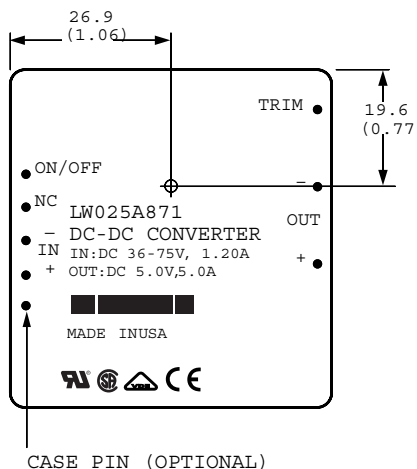

8-1265(C).c

Note: Dimensions are in millimeters and (inches). Pin locations are for reference only.

Figure 14. Case Temperature Measurement Location

Note that the view in Figure 14 is of the metal surface of the module—the pin locations shown are for reference. The temperature at this location should not exceed the maximum case temperature indicated in the derating curve shown in Figure 16. The output power of the module should not exceed the rated power for the module as listed in the Ordering Information table.

Heat Transfer

Increasing airflow over the module enhances the heat transfer via convection. Figure 16 shows the maximum power that can be dissipated by the module without exceeding the maximum case temperature versus local ambient temperature (T_A) for natural convection through 3.0 ms^{-1} (600 ft./min.).

Systems in which these power modules may be used typically generate natural convection airflow rates of 0.3 ms^{-1} (60 ft./min.) due to other heat-dissipating components in the system. Therefore, the natural convection condition represents airflow rates of up to 0.3 ms^{-1} (60 ft./min.). Use of Figure 16 is shown in the following example.

Example

What is the minimum airflow necessary for a LW025A operating at $V_I = 75 \text{ V}$, an output current of 3.5 A, and a maximum ambient temperature of $85 \text{ }^\circ\text{C}$?

Solution

Given: $V_I = 75 \text{ V}$, $I_O = 3.5 \text{ A}$, $T_A = 85 \text{ }^\circ\text{C}$
 Determine P_D (Figure 18): $P_D = 4.5 \text{ W}$
 Determine airflow (Figure 16): $v = 1.0 \text{ ms}^{-1}$ (200 ft./min.)

Thermal Considerations (continued)

Heat Transfer (continued)

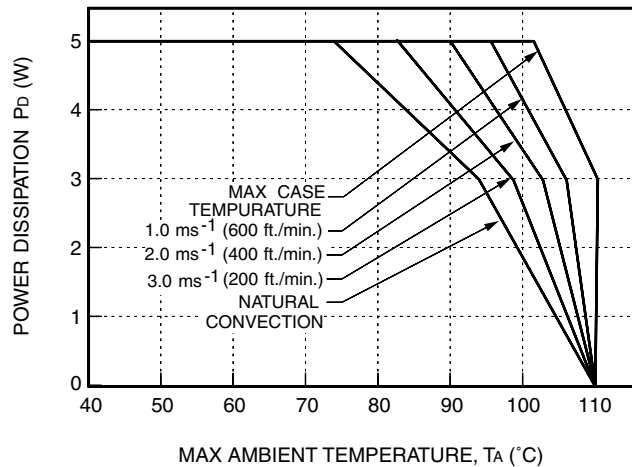

8-2477(C)

Note: Conversion factor for linear feet per minute to meters per second: 200 ft./min. = 1 ms⁻¹.

Figure 15. LW025F Forced Convection Power Derating; Either Orientation

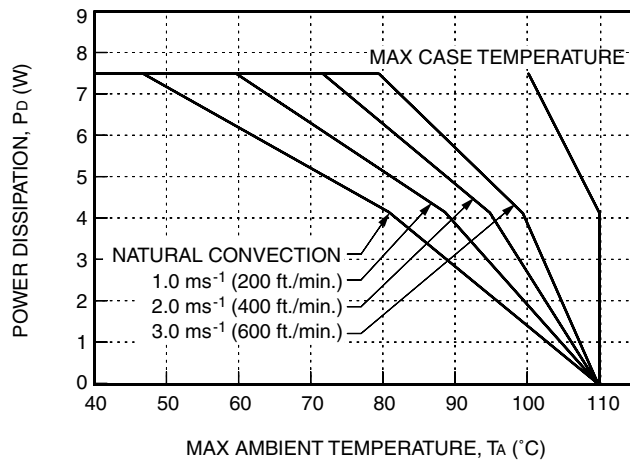

8-1985(C)

Note: Conversion factor for linear feet per minute to meters per second: 200 ft./min. = 1 ms⁻¹.

Figure 16. LW025A Forced Convection Power Derating; Either Orientation

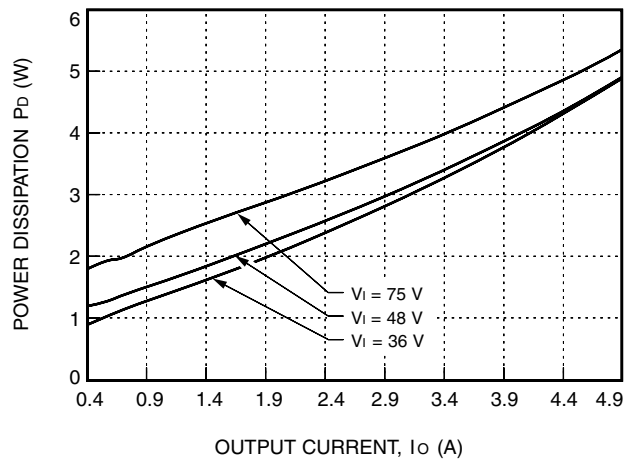

8-2479(C)

Figure 17. LW025F Power Dissipation vs. Output Current, Ta = 25 °C

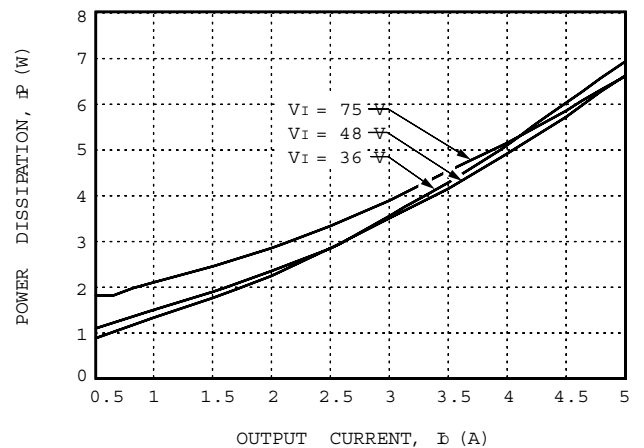

8-1888(C).a

Figure 18. LW025A Power Dissipation vs. Output Current, Ta = 25 °C

Thermal Considerations (continued)

Module Derating

The derating curves in Figure 16 were determined from measurements obtained in an experimental apparatus shown in Figure 19. Note that the module and the printed-wiring board (PWB) that it is mounted on are vertically oriented. The passage has a rectangular cross-section.

Layout Considerations

Copper paths must not be routed beneath the power module standoffs.

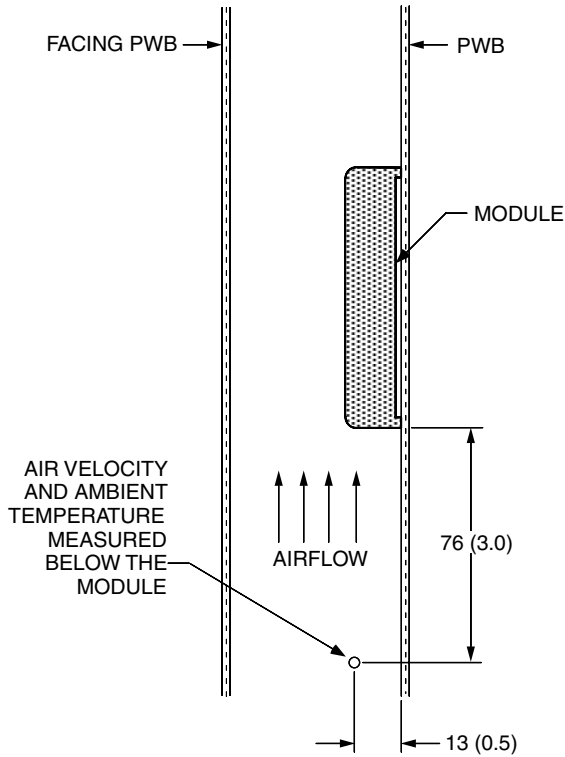

Note: Dimensions are in millimeters and (inches).

Figure 19. Experimental Test Setup

Outline Diagram

Dimensions are in millimeters and (inches).

Tolerances: $x.x \pm 0.5$ mm (0.02 in.), $x.xx \pm 0.25$ mm (0.010 in.). Pin-to-pin tolerances are not cumulative.

Note: For standard modules, $V_i(+)$ is internally connected to the case.

Top View

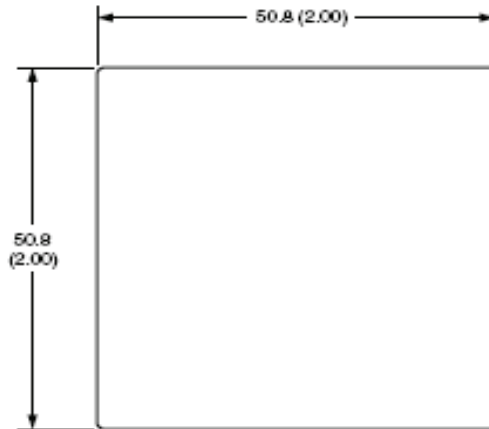

Pin	Function
1	Remote On/Off
2	No Connection (sync feature optional)
3	$V_i(-)$
4	$V_i(+)$
5	Case Pin (pin optional)
6	Trim
7	- Output
8	+ Output

Side View

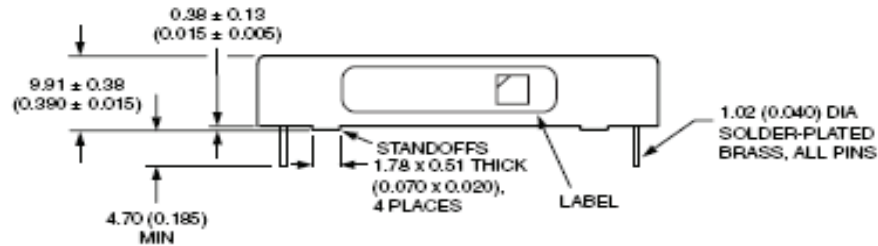

Bottom View

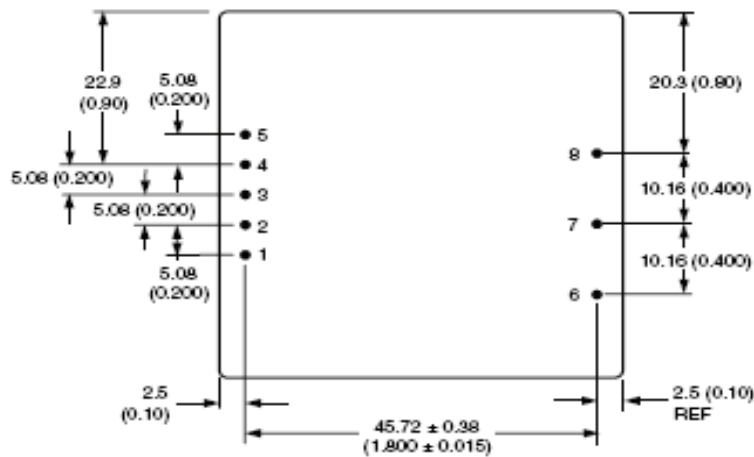

8-1198(C).f2

Recommended Hole Pattern

Component-side footprint. Dimensions are in millimeters and (inches).

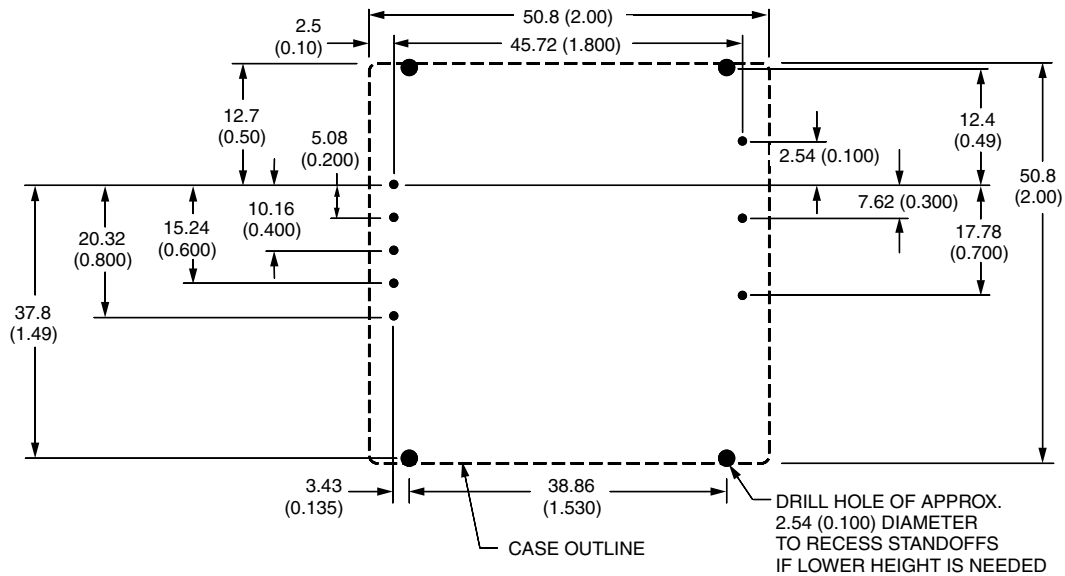

8-1198(C).f

Ordering Information

Table 4. Device Codes

Input Voltage	Output Voltage	Output Power	Device Code	Comcode
48 V	3.3 V	16.5 W	LW025F	108448234
48 V	5 V	25 W	LW025A	TBD

Optional features may be ordered using the device code suffixes shown below. To order more than one option, list suffixes in numerically descending order. Please contact your Lineage Power Account Manager or Field Application Engineer for pricing and availability.

Table 5. Option Codes

Option	Device Code Suffix
Short pins: 2.79 mm ± 0.25 mm (0.110 in. ± 0.010 in.)	8
Case ground pin	7
Short pins: 3.68 mm ± 0.25 mm (0.145 in. ± 0.010 in.)	6
Synchronization	3
Negative logic on/off	1

Notes



World Wide Headquarters

Lineage Power Corporation

3000 Skyline Drive, Mesquite, TX 75149, USA

+1-800-526-7819

(Outside U.S.A.: **+1-972-284-2626**)

www.lineagepower.com

e-mail: techsupport1@lineagepower.com

Asia-Pacific Headquarters

Tel: +65 6416 4283

Europe, Middle-East and Africa Headquarters

Tel: +49 89 6089 286

India Headquarters

Tel: +91 80 28411633

Lineage Power reserves the right to make changes to the product(s) or information contained herein without notice. No liability is assumed as a result of their use or application. No rights under any patent accompany the sale of any such product(s) or information.

© 2008 Lineage Power Corporation, (Mesquite, Texas) All International Rights Reserved.