

# DSB15IM30UC

## 30 V, 15 A Schottky Rectifier Diode

RoHS

Pb

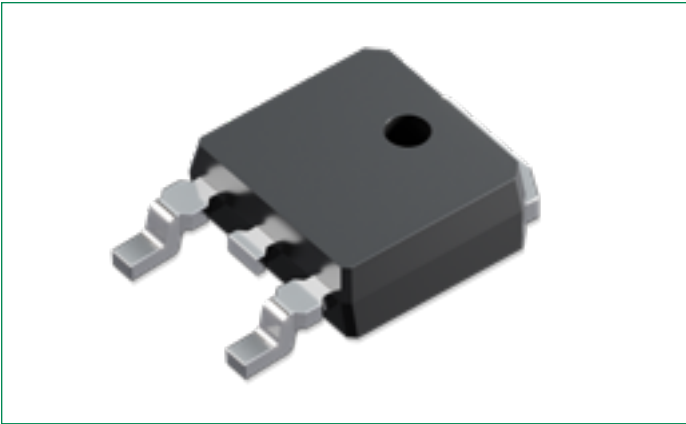

### Features:

- Very low  $V_f$
- Extremely low switching losses
- Low  $I_{rm}$  values
- Improved thermal behavior
- High reliability circuit operation
- Low voltage peaks for reduced protection circuits
- Low noise switching
- Terminals finish: 100% Pure Tin
- This is a Pb-free Device
- Epoxy meets UL 94V-0

### Pinout Diagram (TO-252AA)

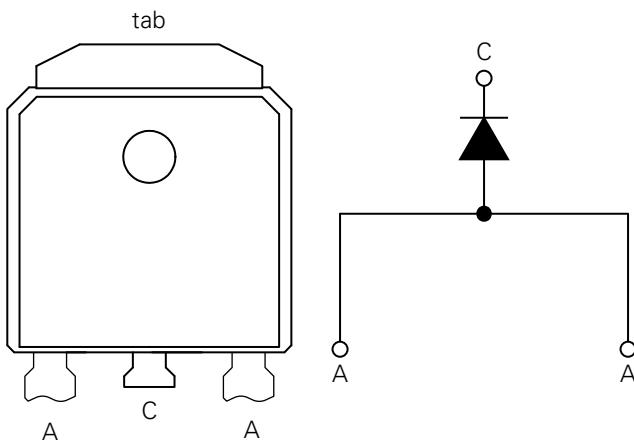

**C:** Cathode; **A:** Anode; **tab:** Cathode

### Applications:

- Rectifiers in Switch Mode Power Supplies (SMPS)
- Free wheeling diode in low voltage converters

**Maximum Ratings** ( $T_A = 25^\circ\text{C}$  unless otherwise specified)

Symbol	Characteristics	Condition	Max.	Units
$V_{RRM}$	Peak Repetitive Reverse Voltage	–	30	V
$V_{RWM}$	Working Peak Reverse Voltage			
$V_R$	DC Blocking Voltage			
$I_{F(AV)}$	Average Rectified Forward Current	50% duty cycle @ $T_C=130^\circ\text{C}$ , rectangular wave form	15	A
$I_{FSM}$	Peak One Cycle Non-Repetitive Surge Current	10 ms, Half Sine pulse, $T_J=25^\circ\text{C}$	300	A
$P_{tot}$	Total power dissipation	$T_C=25^\circ\text{C}$	65	W

**Electrical Characteristics** ( $T_A = 25^\circ\text{C}$  unless otherwise specified)

Symbol	Characteristics	Conditions	Typ.	Max.	Units
$V_{F1}$	Forward Voltage Drop <sup>1</sup>	@ 15A, Pulse, $T_J = 25^\circ\text{C}$	–	0.51	V
$V_{F2}$		@ 15A, Pulse, $T_J = 125^\circ\text{C}$	–	0.44	V
$I_{R1}$	Reverse Current*	@ $V_R = \text{rated } V_{Rr}$ , $T_J = 25^\circ\text{C}$	–	5	mA
$I_{R2}$		@ $V_R = \text{rated } V_{Rr}$ , $T_J = 100^\circ\text{C}$	–	40	mA
$C_T$	Junction Capacitance	@ $V_R = 24\text{V}$ , $T_C = 25^\circ\text{C}$ , $f_{SIG} = 1\text{MHz}$	357	–	pF

**Note 1:** Pulse width < 300  $\mu\text{s}$ , duty cycle < 2%

**Thermal-Mechanical Specifications**

Symbol	Characteristics	Condition	Specification	Units
$T_J$	Junction Temperature	–	-55 to +150	$^\circ\text{C}$
$T_O$	Operation Temperature	–	-55 to +125	$^\circ\text{C}$
$T_{stg}$	Storage Temperature	–	-55 to +150	$^\circ\text{C}$
$F_C$	Mounting force with clip	–	Min 20 Max 60	N
$R_{\theta JC}$	Maximum Thermal Resistance Junction to Case	DC operation	2	$^\circ\text{C/W}$
$R_{\theta CS}$	Typical Thermal Resistance Case to Heat Sink	–	0.50	$^\circ\text{C/W}$
wt	Approximate Weight	–	0.39	g

## Characteristic Curves

**Fig. 1. Typical Forward Characteristics**

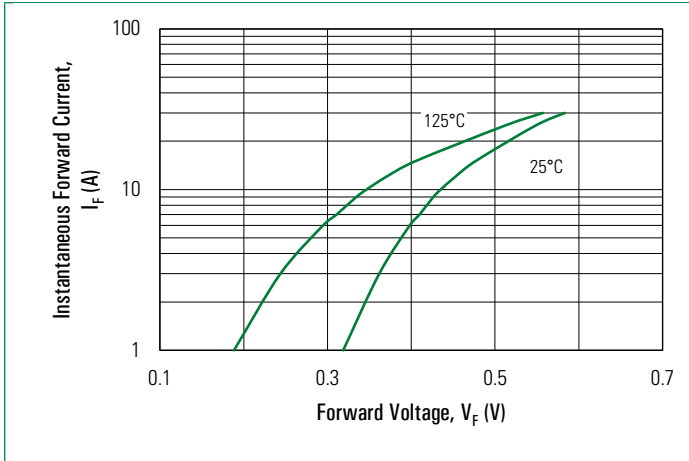

**Fig. 2. Typical Reverse Characteristics**

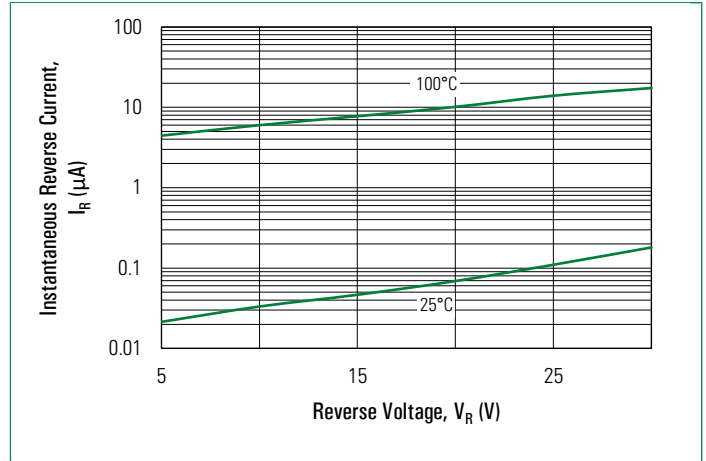

**Fig. 3. Typical Junction Capacitance**

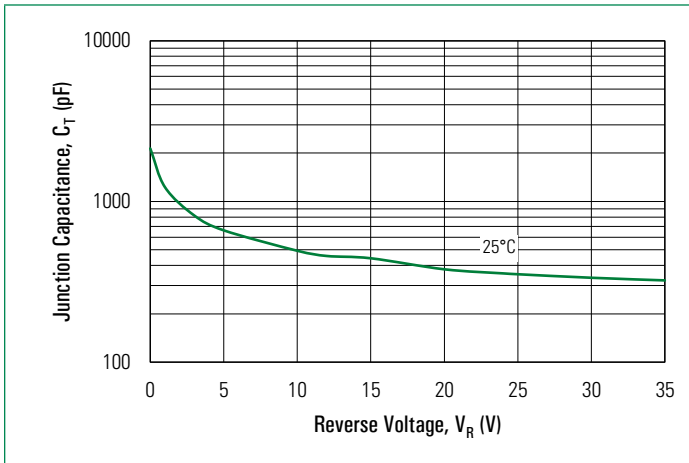

Part Outline Drawing (TO-252AA)

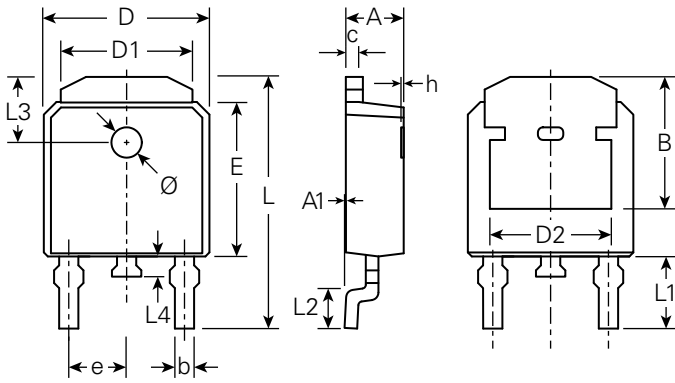

Symbol	Inches			Millimeters		
	Min.	Typical	Max.	Min.	Typical	Max
A	0.085	-	0.094	2.18	-	2.39
A1	-	-	0.005	-	-	0.13
b	0.025	-	0.035	0.64	-	0.89
c	0.018	-	0.035	0.46	-	0.89
D	0.250	-	0.264	6.35	-	6.73
D1	0.195	-	0.215	4.95	-	5.46
D2	0.170	-	-	4.32	-	-
E	0.235	0.240	0.245	5.97	6.10	6.22
e	0.090 BSC			2.29 BSC		
L	0.370	-	0.410	9.40	-	10.41
L1	0.114			2.90 REF		
L2	0.055	0.060	0.070	1.40	1.52	1.78
L3	0.063 REF			1.60 REF		
L4	-	-	0.040	-	-	1.02
Ø	0.043	-	0.051	1.10	-	1.30

Part Number and Marking

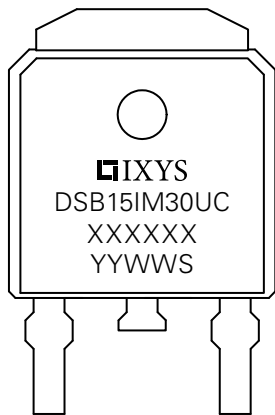

- DS = Schottky Diode
- B = Ultra Low VF
- 15 = Current Rate (15A)
- IM = Single Diode
- 30 = Voltage Rating (30V)
- UC = Package Code (TO-252)
- YY = Year
- WW = Work Week
- S = Plant Location Code
- XXXXXX = Lot Number

Ordering Information

Part Number	Marking	Packing Mode	Quantity
DSB15IM30UC-TRL	DSB15IM30UC	Reel	2500 pcs/ reel

## Carrier Tape Specification (TO-252AA)

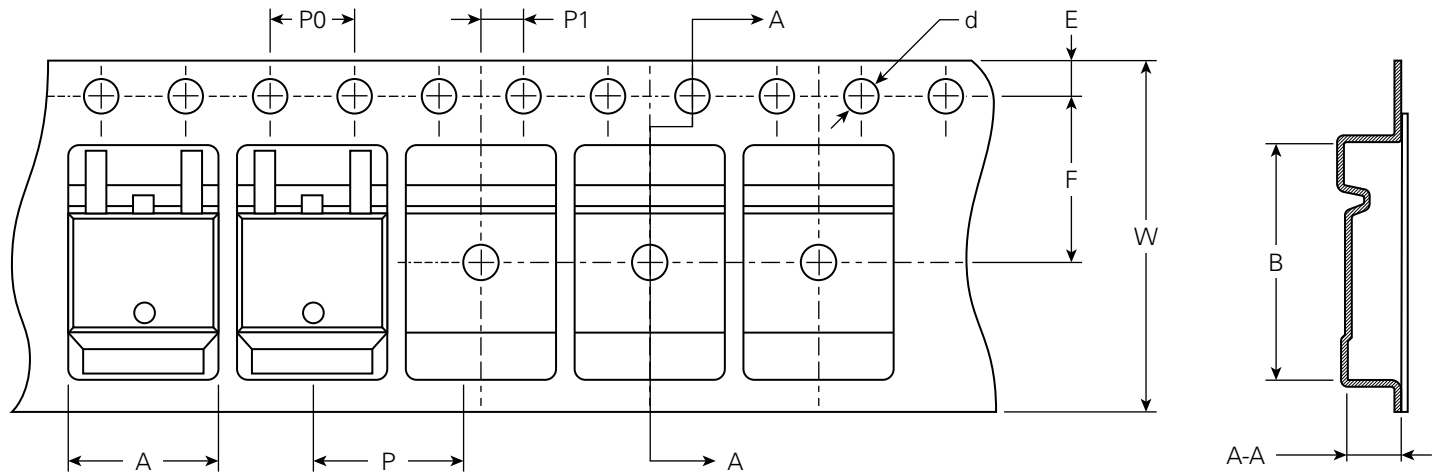

Symbol	Inches			Millimeters		
	Min.	Typical	Max.	Min.	Typical	Max.
A	0.267	-	0.276	6.80	-	7.00
B	0.409	-	0.417	10.40	-	10.60
C	0.102	-	0.110	2.60	-	2.80
d	Ø0.057	-	Ø0.065	Ø1.45	-	Ø1.65
E	0.065	-	0.073	1.65	-	1.85
F	0.291	-	0.299	7.40	-	7.60
P0	0.154	-	0.161	3.90	-	4.10
P	0.311	-	0.319	7.90	-	8.10
P1	0.075	-	0.083	1.90	-	2.10
W	0.626	-	0.642	15.90	-	16.30

**Disclaimer Notice** - Information furnished is believed to be accurate and reliable. However, users should independently evaluate the suitability of and test each product selected for their own applications. Littelfuse products are not designed for, and may not be used in, all applications. Read complete Disclaimer Notice at <http://www.littelfuse.com/disclaimer-electronics>.