

Type 5SF / 5SFP

Quick-acting Fuse Series (Low Breaking Capacity)

HF Pb 5SF/5SFP Series, 5x20mm Glass Tube Quick-acting Fuse

RoHS Compliant

Description

5x20mm quick-acting, low breaking capacity, glass tube body cartridge fuse designed, approved and complied with IEC 60127-2, standard sheet 2.



Features

- Meet IEC standard 60127-2, sheet 2
- Wide operating temperature range
- Bulk and Tape & Reel packing available
- Full compliance with EU Directive 2011/65/EU and amending directive 2015/863
- Halogen Free
- Lead Free

Applications

Provide individual protection for components or internal circuits.

- Power supplies
- Battery charger
- Monitor
- Adapter

LEAD FREE = 
 HALOGEN FREE = 



Physical Specifications





Materials	Body : Glass
	Cap : Nickel Plated Brass Caps
	Leads : Matte Tin Plated Copper
Marking	On Fuse :
	"bel", "F", "Current Rating", "L", "250V",
	"Appropriate Safety Logos", "✓" (RoHS compliant)
	On Label :
	"bel", "5SF" or "5SFP", "F", "Current Rating", "L", "Voltage Rating", "Interrupting Rating", "Appropriate Safety Logos" and "✓", "RoHS", "E" (China RoHS compliant).

Electrical Characteristics (IEC-127-2 STANDARD SHEET 2)

Rated Current	1.5 In		2.1 In		2.75 In		4 In		10 In
	MIN	MAX	MIN	MAX	MIN	MAX	MIN	MAX	MAX
500mA to 6.3A	1	30	50	2	10	300	20		
8A to 10A	1	30	50	2	10	400	40		
	hr.	min.	ms	sec	ms	ms	ms		

In clause 9.2, the test voltage for 5SFP ratings from 1A to 6.3A is 63VDC.





Safety Agency Approvals

Safety Agency	Safety Agency Certificate	Ampere Rating/ Voltage Rating	Ampere Range / Volt @ I.R. ability*
	SE-S-2002382	500mA-10A /250V AC	500mA-6.3A/250V AC@35A or 10 In whichever is greater
	40000509		
	E20624		
	LR39772		
	Self-declaration No: 2020970207000128		500mA-6.3A/250V AC@35A or 10 In whichever is greater
*I.R.= Interrupting Rating = Short Circuit Rating(Amps)			

Environmental Specifications

Shock Resistance	MIL-STD-202G, Method 213B, Test Condition 1 (100 G's peak for 6 milliseconds; Sawtooth waveform)
Vibration Resistance	MIL-STD-202G, Method 201A (10-55 Hz, 0.06 inch, total excursion).
Salt Spray Resistance	MIL-STD-202G, Method 101E, Test Condition B (48 hrs).
Insulation Resistance	MIL-STD-202G, Method 302, Test Condition B (After Opening) 100,000 ohms minimum.
Solderability	MIL-STD-202G, Method 208H
Resistance to solder Heat	MIL-STD-202G, Method 210F, Test Condition B (260+/-5°C, 10+/-1 sec)
Thermal Shock	MIL-STD-202G, Method 107G, Test Condition B (-65°C to +125°C).
Operating Temperature	-55°C to +125°C
Terminal Strength	IEC-68-2-21

Electrical Specifications

Catalog Number	Ampere Rating	Typical Cold Resistance (ohms)	Volt-drop @100%In (Volt) max.	Voltage and Interrupting Ratings	Melting I ² T <10 mSec (A ² Sec)	Melting I ² T @10 In (A ² Sec)	Maximum Power Dissipation (W)	Agency Approvals				
												
5SF(P) 500-R	500mA	0.31	0.27	See Table of Safety Approvals on Page 1 for Voltage and associated Interrupting Ratings	0.40	0.40	0.80	Y	Y	Y	Y	Y
5SF(P) 630-R	630mA	0.152	0.13		0.64	0.65	0.28	Y	Y	Y	Y	Y
5SF(P) 800-R	800mA	0.112	0.13		1.0	1.0	0.32	Y	Y	Y	Y	Y
5SF(P) 1-R	1A	0.088	0.13		1.6	1.7	0.40	Y	Y	Y	Y	Y
5SF(P) 1.25-R	1.25A	0.065	0.12		2.5	2.7	0.45	Y	Y	Y	Y	Y
5SF(P) 1.6-R	1.6A	0.050	0.11		4.0	4.4	0.75	Y	Y	Y	Y	Y
5SF(P) 2-R	2A	0.034	0.10		6	7	0.65	Y	Y	Y	Y	Y
5SF(P) 2.5-R	2.5A	0.026	0.10		10	11	0.85	Y	Y	Y	Y	Y
5SF(P) 3.15-R	3.15A	0.022	0.10		16	18	1.20	Y	Y	Y	Y	Y
5SF(P) 4-R	4A	0.017	0.10		26	30	1.43	Y	Y	Y	Y	Y
5SF(P) 5-R	5A	0.013	0.10		41	48	1.89	Y	Y	Y	Y	Y
5SF(P) 6.3-R	6.3A	0.010	0.10		65	74	2.50	Y	Y	Y	Y	Y
5SF(P) 8-R	8A	0.007	0.08		103	119	3.30	Y	Y			
5SF(P) 10-R	10A	0.006	0.08		163	192	4.00	Y	Y			

Consult manufacturer for other ratings



Specifications subject to change without notice

Bel Fuse Inc.
206 Van Vorst Street
Jersey City, NJ 07302 USA

+1 201.432.0463
Bel.US.CS@belf.com
belfuse.com/circuit-protection

Temperature Derating Curve

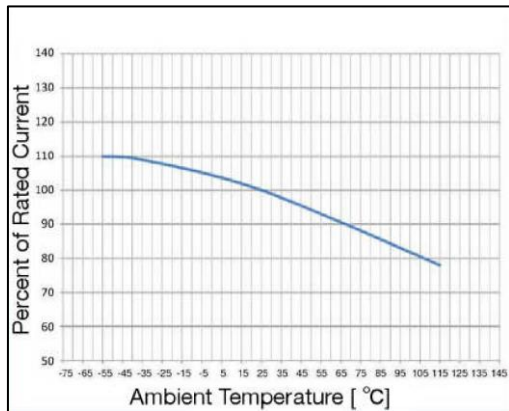

Average Time Current Curve

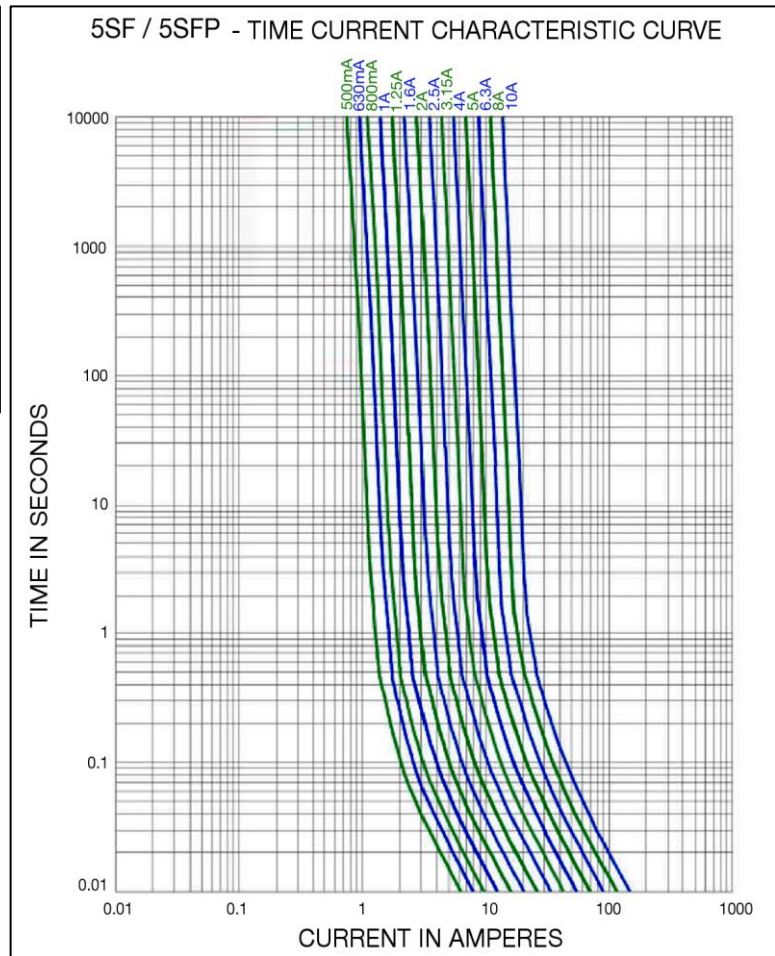

Soldering Parameters

Lead-free Wave Soldering Profile	
Wave Soldering Parameter	
Average ramp-up rate	200°C / second
Heating rate during preheat	typical 1 - 2°C / second Max 4°C / second
Final preheat temperature	within 125°C of soldering temperature
Peak temperature T _p	260°C
Time within +0°C / -5°C of actual peak temperature	10 seconds
Ramp-down rate	5°C / second max.

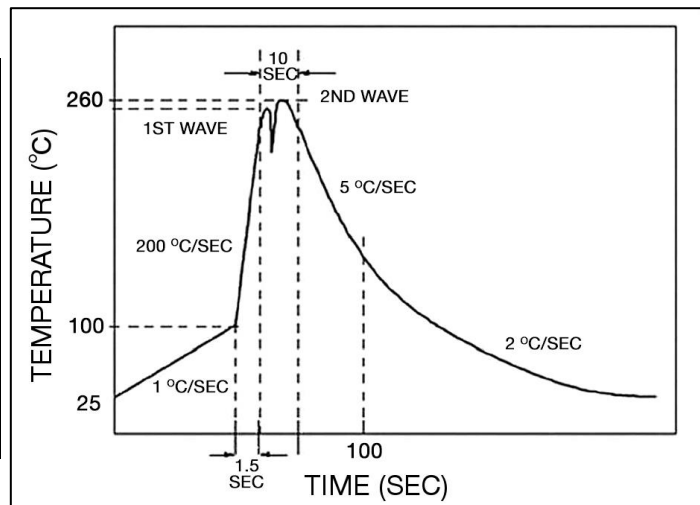

Fuse FGNO Explanation

0651 R [XXXX] -XX

[XXXX]=Ampere Rating; XX=See Ordering Information as below

Fraction	Decimal	Milliamps	Bel FGNO[XXXX]
1/2	.500	500	0500
	.630	630	0630
8/10	.800	800	0800

Fraction	Decimal	Amps	Bel FGNO[XXXX]
	1.0	1	1000
1-1/4	1.25	1.25	1250
	1.60	1.6	1600
	2.0	2	2000
2-1/2	2.5	2.5	2500
	3.15	3.15	3150
	4.0	4	4000
	5.0	5	5000
	6.3	6.3	6300
	8.0	8	8000
		10	9100

Mechanical Dimensions

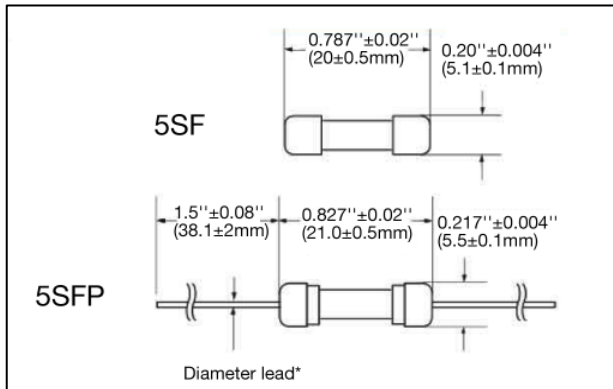

*Ratings 6.3A and less have 0.032" ± 0.002" diameter lead;

*Ratings 8A and above have 0.039" ± 0.002" diameter lead.

Ordering Information

0651 R XXXX - X X

FUSE TYPE
0651RXXXX-1X = 5SF/5SFP Series

R = RoHS Compliant

AMPERE RATING
Refer to fuse FGNO explanation table

SAFETY STANDARD CODE
1 = IEC, 250V, 500mA - 10A

QUANTITY & PACKAGING CODE
1 = Cartridge version, 1K / box
3 = Pigtail version, Bulk, 500 / box
6 = Pigtail version, Tape and Reel, 1500 / reel

Packaging

Packaging Option	Packaging Specification	Quantity	Packaging Code	Inside Tape Spacing
Bulk	N/A	1000	11	N/A
Bulk (Pigtail Type)	N/A	500	13	N/A
Tape & Reel	EIA-296-F	1500	16	10mm Pitch and 63mm



Specifications subject to change without notice

Bel Fuse Inc.
206 Van Vorst Street
Jersey City, NJ 07302 USA

+1 201.432.0463
Bel.US.CS@belf.com
belfuse.com/circuit-protection