

bq24187 Evaluation Module User's Guide

The bq24187 evaluation module is a complete charger module for evaluating compact, flexible, high-efficiency, USB-friendly, switch-mode charge management solution for single-cell, Li-ion and Li-polymer batteries used in a wide range of portable applications.

Contents

1	Introduction	2
	1.1 BQ24187 IC Features	2
	1.2 bq24187EVM Features	2
	1.3 Schematic.....	3
	1.4 I/O Description	4
	1.5 Test Points to IC Pins	4
	1.6 Control and Key Parameters Setting	4
	1.7 Recommended Operating Conditions	5
2	Test Summary	5
	2.1 Definitions.....	5
	2.2 Recommended Test Equipment	5
	2.3 Recommended Test Equipment Setup	7
	2.4 Recommended Test Procedure.....	9
3	Printed-Circuit Board Layout Guideline.....	10
4	Bill of Materials and Board Layout	11
	4.1 Bill of Materials	11
	4.2 Board Layout.....	12

List of Figures

1	bq2418xEVM Schematic.....	3
2	BAT_Load (PR1010) Schematic.....	6
3	Connections of HPA172 Kit	7
4	Recommended Initial Test Setup for bq24187EVM-625	8
5	Main Window of BQ24187SW Evaluation Software.....	8
6	Top Assembly Layer	12
7	Top Layer	13
8	First Internal Layer	14
9	Second Internal Layer	15
10	Bottom Layer.....	16

List of Tables

1	Bill of Materials - PWR625A	11
---	-----------------------------------	----

1 Introduction

1.1 BQ24187 IC Features

The BQ24187 family integrates a synchronous PWM controller, power MOSFETs, input-current sensing, high-accuracy current and voltage regulation and charge termination into a small WCSP package. The charge parameters can be programmed through an I²C interface. Key IC features include:

- High-efficiency, fully integrated, NMOS-NMOS, synchronous buck charger with 1.5-MHz frequency
- Charge time optimizer
- Integrated power FETs for up to 2-A charge rate
- 5-V, 1-A on-the-go (OTG) VBUS supply

For details, see the bq24187 data sheet ([SLUSBM0](#)).

1.2 bq24187EVM Features

The bq24187 evaluation module (EVM) provides a complete charger module for evaluating compact, flexible, high-efficiency, USB-friendly, switch-mode battery charge solutions for single-cell, Li-ion and Li-polymer battery-powered systems used in a wide range of portable applications. Key EVM features include:

- Terminal blocks and standard headers for IN, BAT, TS; USB connector for IN
- Programmable battery voltage, charge current, input current, and status via I²C interface
- IN operating up to 6.0 V
- LED indication for status signals
- Test points for key signals available for testing purposes. Easy probe hook-up

1.3 Schematic

Figure 1 illustrates the bq2418x EVM schematic.

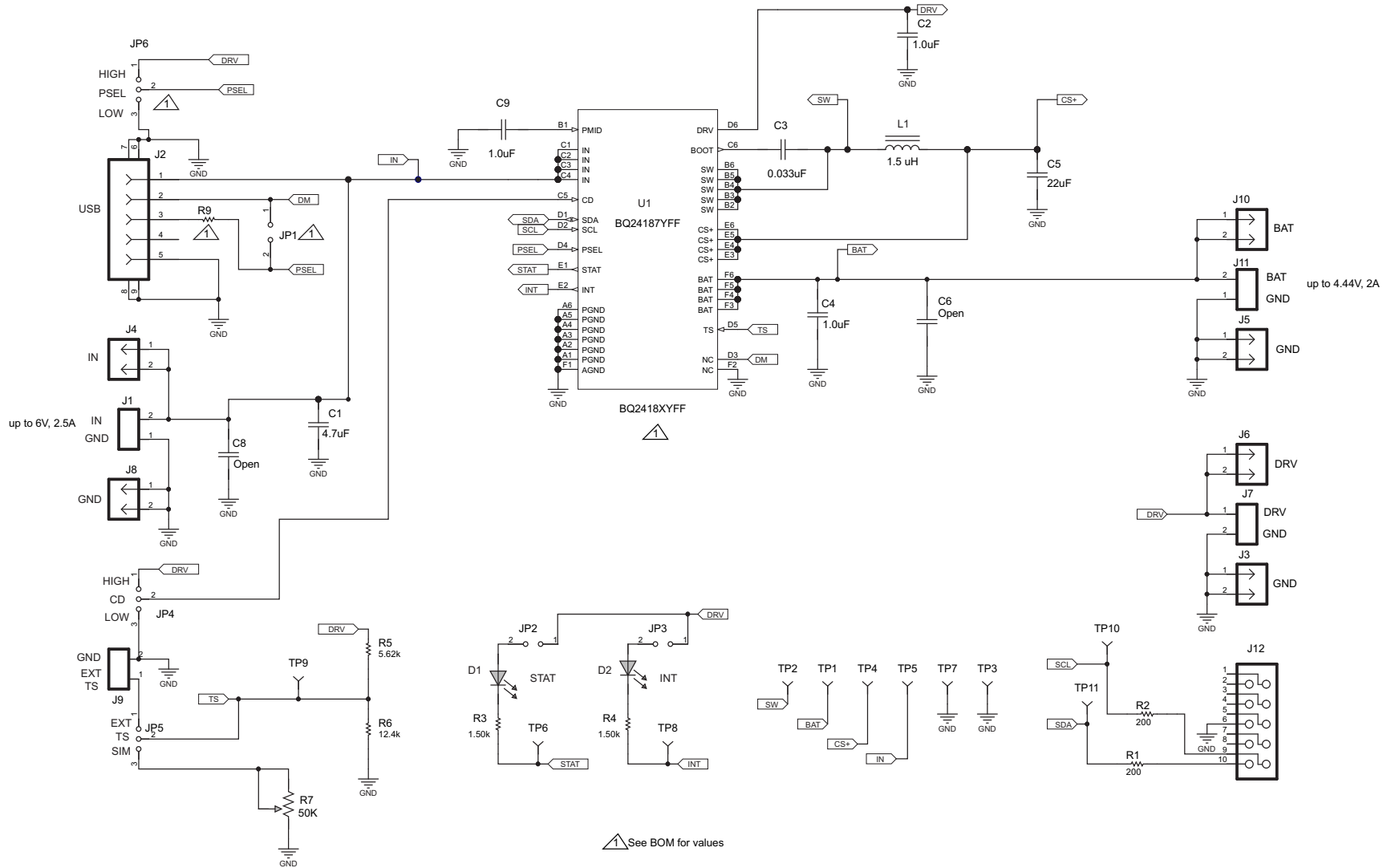

Figure 1. bq2418xEVM Schematic

1.4 I/O Description

Header/Terminal Block	Description
J1- IN/GND	Input power positive and negative terminal
J2 - USB	USB miniconnector
J3 - GND	DRV linear regulator negative header
J4 - IN	Input power positive header
J5 - GND	Battery negative header
J6 - DRV	DRV linear regulator positive output
J7 - DRV/GND	DRV linear regulator positive and negative terminals
J8 - GND	Input power negative header
J9 - EXT TS/GND	External thermistor terminal
J10 - GND	Battery positive header
J11 - BAT/GND	Battery positive and negative terminal
J12 - USB-TO-GPIO	USB-TO-GPIO box keyed connector

1.5 Test Points to IC Pins

Test Point	Description
TP1	BAT
TP2	SW
TP3	GND
TP4	CS+
TP5	GND
TP6	STAT
TP7	GND
TP8	INT
TP9	TS
TP10	SCL
TP11	SDA

1.6 Control and Key Parameters Setting

Jumper	Description	Default Factory Setting
JP1	N/A	Not installed
JP2	Shorting jumper to connect DRV to anode of D1 STAT LED	SHORTED
JP3	Shorting jumper to connect DRV to anode of D1 INT LED	SHORTED
JP4	CD = LO: Charge disable low for normal operation CD = HI: Charge disable high to disable the buck converter and enter Hi-Z mode	CD = LO
JP5	TS = SIM: Connects a potentiometer to the TS pin so that the potentiometer can simulate a thermistor. The potentiometer is preset per R5 and R6 so that the TS voltage is $0.5 \times V$ (DRV). TS = EXT: Connects the TS pin to an external thermistor through J9. The resistor divider formed by R5 and R6 is sized to accommodate a 10-k Ω thermistor. If a different thermistor is used, R5 and R6 must be resized.	TS=SIM
JP6	PSEL = LOW: Input current limit is set to 1.5 A until changed by I2C. PSEL = HIGH: Default mode input current limit is set to 100 mA until changed by I2C. Default mode input current limit is set to 1.5 A until changed by I2C.	PSEL = LOW

1.7 Recommended Operating Conditions

		Min	Typ	Max	Unit
Supply voltage, V_{IN}	Input voltage from ac adapter (bq24262)	4.2		6.0	V
Battery voltage, V_{BAT}	Voltage output at VBAT terminal (registers set via I2C communication)	3.5	4.2	4.44	V
Supply current, $I_{IN(MAX)}$	Maximum input current from ac adapter input (registers set via I2C communication)	0.1		2.0	A
Fast charge current, $I_{CHRG(MAX)}$	Battery charge current (registers set via I2C communication)	0.500		2.0	A
Operating junction temperature range, T_J		-40		125	°C

2 Test Summary

This procedure describes one test configuration of the HPA721 evaluation board for bench evaluation.

2.1 Definitions

The following naming conventions are followed.

VXXX :	External voltage supply name (VADP, VBT, VSBT)
LOADW:	External load name (LOAD1, LOAD2)
V(TPyyy):	Voltage at internal test point TPyyy. For example, V(TP12) means the voltage at TP12.
V(Jxx):	Voltage at header Jxx
V(TP(XXX)):	Voltage at test point XXX. For example, V(ACDET) means the voltage at the test point which is marked as ACDET.
V(XXX, YYY):	Voltage across point XXX and YYY
I(JXX(YYY)):	Current going out from the YYY terminal of header XX
Jxx(BBB):	Terminal or pin BBB of header xx
JPx ON :	Internal jumper Jxx terminals are shorted
JPx OFF:	Internal jumper Jxx terminals are open
JPx (-YY-) ON:	Internal jumper Jxx adjacent terminals marked as YY are shorted
Measure: → A,B	Check specified parameters A, B. If measured values are not within specified limits, the unit under test has failed.
Observe → A,B	Observe if A, B occur. If they do not occur, the unit under test has failed.

Assembly drawings have locations for jumpers, test points, and individual components.

2.2 Recommended Test Equipment

2.2.1 Power Supplies

1. A power supply #1 (PS #1) capable of supplying 5 V at 2.5 A, is required.
2. If not using a battery as the load, then power supply #2 (PS #2) capable of supplying up to 5 V at 5 A is required to power the circuit shown in [Figure 2](#).

2.2.2 Load #1 Between BAT and GND

Testing with an actual battery is the best way to verify operation in the system. If a battery is not available, then a circuit similar to the one shown in [Figure 2](#) can simulate a battery when connected to a power supply. Alternatively, a sourcemeter, capable of sourcing and sinking current can be used to simulate a battery.

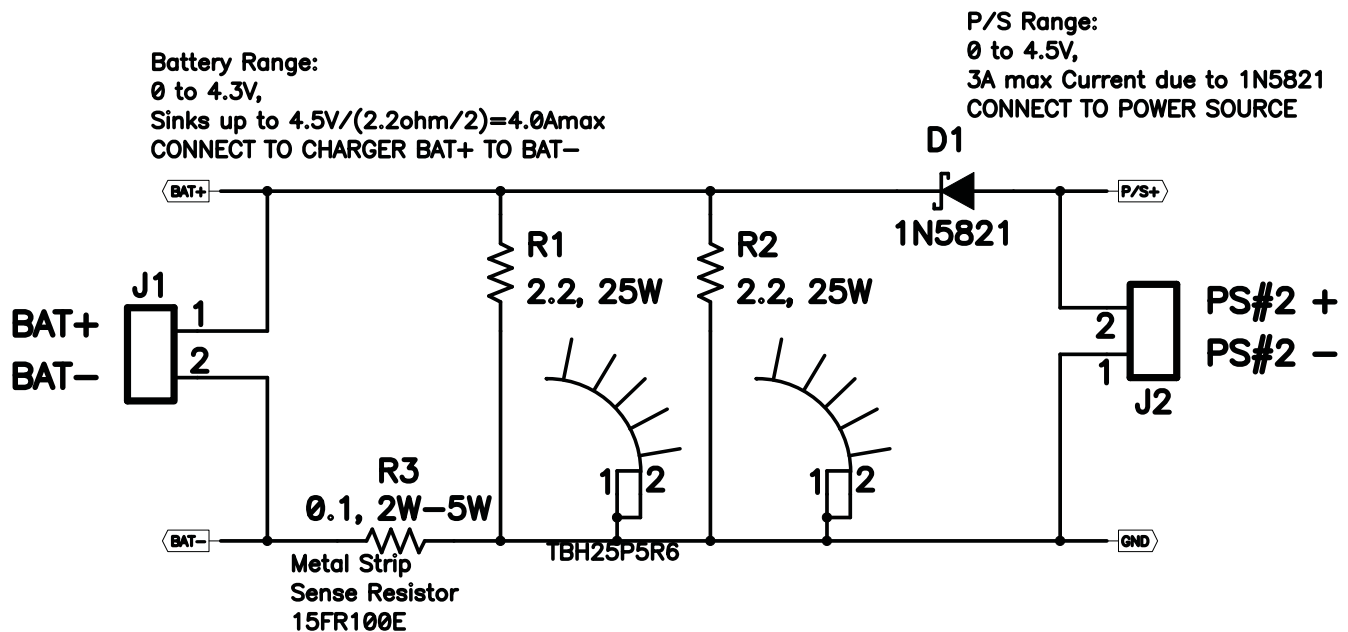

2.2.3 Meters

Four equivalent voltage meters (VM #) and two equivalent current meters (CM #) are required. The current meters must be able to measure 3-A current.

2.2.4 Computer

A computer with at least one USB port and a USB cable is required. The BQ24187 evaluation software must be properly installed.

2.2.5 HPA172 Communication Kit (USB TO GPIO)

An HPA172 USB-to-I²C communication kit is required.

2.2.6 Software

Download BQ24187SW.zip from the charger's product folder, unzip the file, and double-click on the SETUP.EXE file. Follow the installation steps.

Because the bq24187 has a watchdog timer, it is recommended that you set the software's **Reset Watchdog Timer** to reset every 5 seconds. Otherwise, after 30 seconds of operation, the IC enters Default mode. Note that the 27-minute safety timer is not reset by this function and eventually times out if charging does not complete, unless the **Safety Timer Time Limit** is expanded or disabled via the GUI. One way to reset the safety timer is to allow the 30-second watchdog timer to expire. See Figure 3 in the data sheet for more information about the timers.

Also, it is generally helpful to activate the **Write On Change** functions, in the upper left of the GUI window, to ON. The Write On Change function writes any changes to the GUI's check boxes, drop-down boxes, and registers to the IC. Otherwise, the user must click the **WRITE** button to write changes to the software. It is recommended that the user periodically click the **READ** button to find the IC's instantaneous status. Alternatively, the **AutoRead** function can be activated to periodically update the GUI with the IC's status.

2.3 Recommended Test Equipment Setup

1. For all power connections, use short, twisted-pair wires of appropriate gauge wire for the amount of the current.
2. Set PS #1 for 5-V, 2.5-A current limit and then turn off supply.
3. Connect the output of PS #1 in series with a current meter (CM #1) to J1 (IN).
4. Connect a voltmeter (VM #1) across J4 and J3 (IN and GND).
5. If BAT_Load as shown in [Figure 1](#) is used, connect PS #2, set to approximately 3.7 V, to the input side (PS #2+/-) of BAT_Load, then turn off PS #2.
6. Connect the output side of the battery or BAT_Load in series with current meter (multimeter) #2 (CM #2) to J11 and J10 or J5 (BAT, GND). Ensure that a voltage meter (VM #2) is connected across J10 or TP1 and J5 or TP7 (BAT and GND).
7. Connect VM #3 across J6 and J8 (DRV and GND).
8. Connect the HPA172 kit to J12 by the 10-pin ribbon cable. Connect the USB port of the HPA172 kit to the USB port of the computer. The connections are shown in [Figure 3](#).

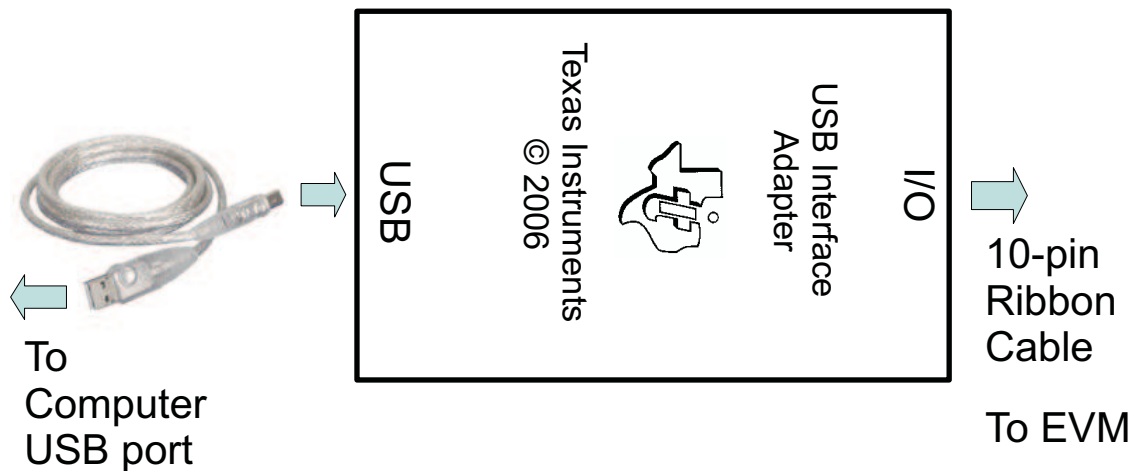

Figure 3. Connections of HPA172 Kit

9. Ensure jumpers are at the settings highlighted in yellow (except for JP1 which is not installed) per [Section 1.6](#).

- After the preceding steps have been performed, the test setup for bq24187EVM-625 is configured as is shown in [Figure 4](#)

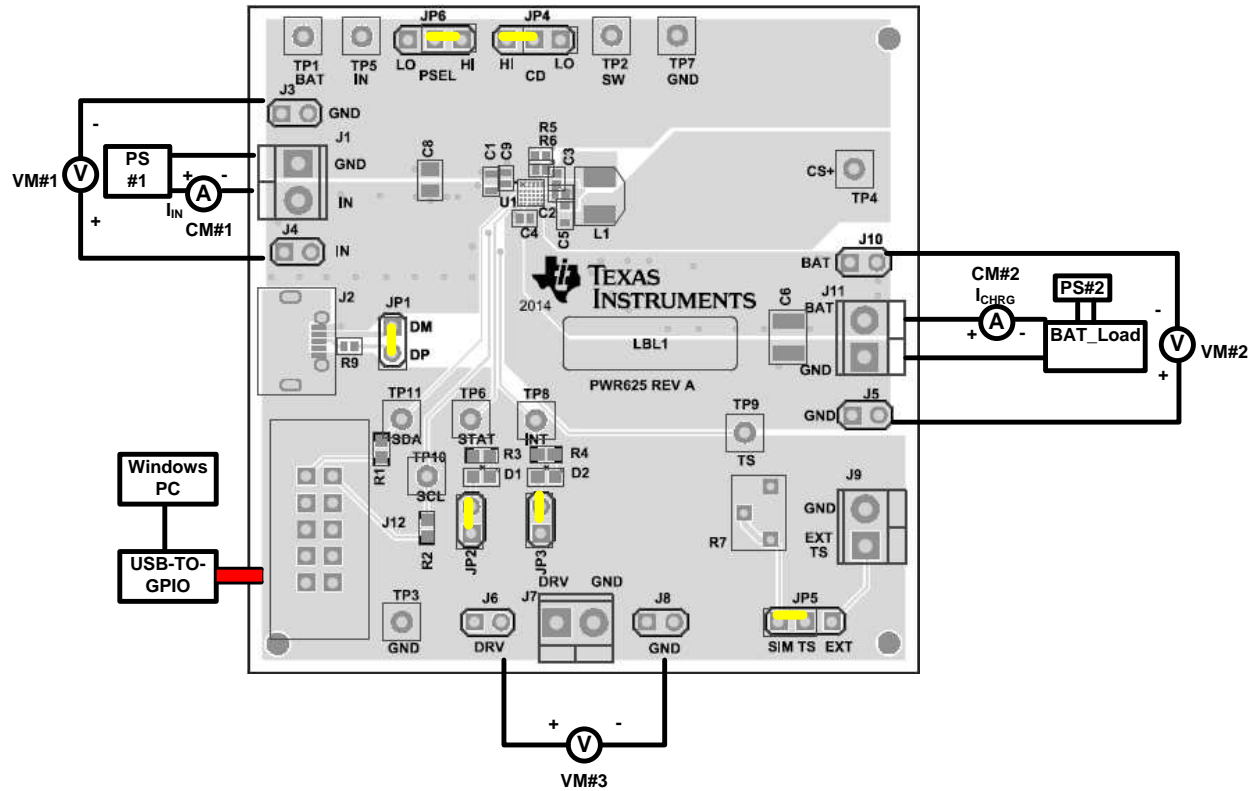

Figure 4. Recommended Initial Test Setup for bq24187EVM-625

- Turn on the computer. Open the BQ24187 evaluation software. [Figure 5](#) shows the main window of the software.

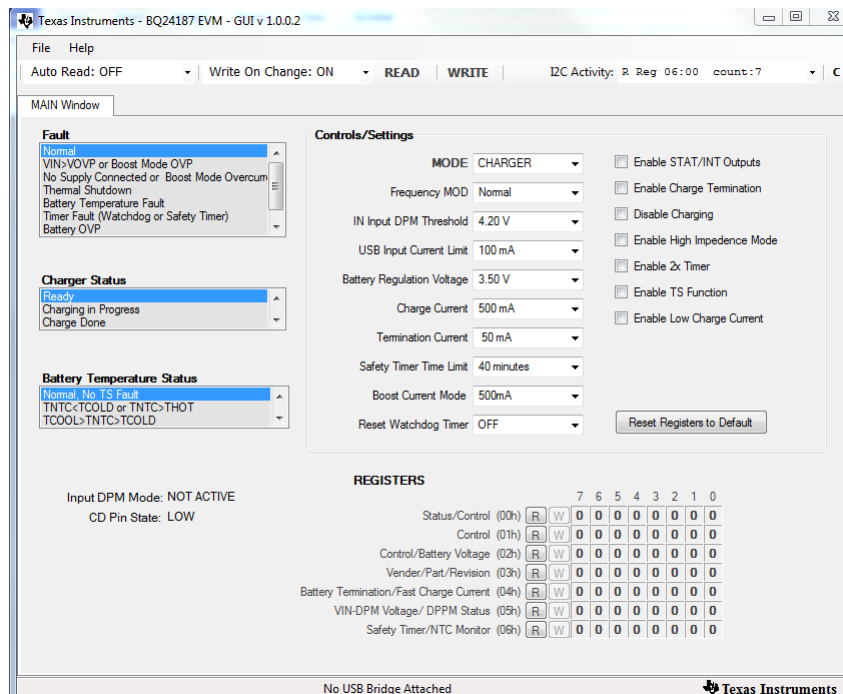

Figure 5. Main Window of BQ24187SW Evaluation Software

2.4 Recommended Test Procedure

The following test procedure may be useful for evaluating the charger IC outside of a real system, if no battery is available to connect to the output and a simulated battery, if needed.

2.4.1 Charge Voltage and Current Regulation of IN

1. Ensure that the steps in [Section 2.3](#) are followed.
2. Move JP4 to LO.
3. Turn on PS #1.
4. Enable PS #2 and adjust PS #2 so that the voltage measured by VM #2, across BAT and GND, measures 3.2 V \pm 50 mV.
5. Adjust the power supply so that VM #1 still reads 5 V \pm 100 mV, if necessary, then
Measure on CM #2 $\rightarrow I_{\text{CHRG}} < 120 \text{ mA}$
Measure on CM #1 $\rightarrow I_{\text{IN}} = 90\text{--}100 \text{ mA}$
6. Software setup:
 - Press the **READ** button to obtain the current settings.
 - Set **Write On Change** to ON, if not already set.
 - Set **Safety Timer** to Disabled.
 - Set **Reset Watchdog Timer** to update every 5 seconds.
 - Uncheck **Disable Charging** if checked.
 - Check **Enable STAT/INT Outputs**.
 - Set **Battery Regulation Voltage** to 4.20 V.
 - Set **IN Input Current Limit** to 2.0 A.
 - Set **Charge Current** to 1000 mA.
 - Click the **READ** button at the top of the window and confirm that the previous settings remain.
7. Enable PS #2 and adjust PS #2 so that the voltage measured by VM #2, across BAT and GND, measures 3.8 V \pm 50 mV.
8. Adjust the power supply so that VM #1 still reads 5 V \pm 100 mV, if necessary, then
Measure on CM #2 $\rightarrow I_{\text{CHRG}} = 1000 \text{ mA} \pm 50 \text{ mA}$
Measure on CM #1 $\rightarrow I_{\text{IN}} < 750 \text{ mA}$
9. Turn off PS #1 and PS #2.

2.4.2 Helpful Hints

1. To observe the taper current as the battery voltage approaches the set regulation voltage, allow the battery to charge or, if using BAT_Load (PR1010), slowly increase the PS #2 voltage powering BAT_Load (PR1010). Use VM #2 across BAT and GND to measure the battery voltage seen by the IC.
2. To observe the VIN-DPM feature, lower the current limit on PS #1.

3 Printed-Circuit Board Layout Guideline

1. To obtain optimal performance, the power input capacitors, connected from the PMID input to PGND, must be placed as close as possible to the IC.
2. Place 4.7- μ F input capacitor as close to PMID pin and PGND pin as possible to make the high-frequency current loop area as small as possible. Place 1- μ F input capacitor GNDs as close to the respective PMID capacitor GND and PGND pins as possible to minimize the ground difference between the input and PMID.
3. The local bypass capacitor from CS+ to GND must be connected between the CS+ pin and PGND of the IC. The intent is to minimize the current path loop area from the SW pin through the LC filter and back to the PGND pin.
4. Place all decoupling capacitors close to their respective IC pins and as close as possible to PGND (do not place components such that routing interrupts power stage currents). All small control signals must be routed away from the high-current paths.
5. The PCB must have a ground plane (return) connected directly to the return of all components through vias (two vias per capacitor for power-stage capacitors, one via per capacitor for small-signal components). It is also recommended to put vias inside the PGND pads for the IC, if possible. A star ground design approach is typically used to keep circuit block currents isolated (high-power/low-power small-signal) which reduces noise-coupling and ground-bounce issues. A single ground plane for this design gives good results. With this small layout and a single ground plane, no ground-bounce issue exists, and having the components segregated minimizes coupling between signals.
6. The high-current charge paths into IN, USB, BAT, and from the SW pins must be sized appropriately for the maximum charge current in order to avoid voltage drops in these traces. The PGND pins must be connected to the ground plane to return current through the internal low-side FET.
7. For high-current applications, the balls for the power paths must be connected to as much copper in the board as possible. This allows better thermal performance because the board conducts heat away from the IC.

4 Bill of Materials and Board Layout

4.1 Bill of Materials

Table 1 lists the bq24187EVM-625 Rev A BOM.

Table 1. Bill of Materials - PWR625A

Designator	Qty	Value	Description	Package Reference	Part Number	Manufacturer	Alternate Part Number	Alternate Manufacturer
!PCB	1		Printed Circuit Board		PWR625	Any	-	-
C1	1	4.7uF	Capacitor, Ceramic Chip, 25V, X5R, ±20%	603	C1608X5R1E475M080AC	TDK		
C2, C4	2	1.0uF	Capacitor, Ceramic Chip, 6.3V, X5R, ±10%	402	C1005X5R0J105K050BB	TDK		
C3	1	0.033uF	Capacitor, Ceramic Chip, 25V, X5R, ±10%	402	C1005X5R1E333K050BA	TDK		
C5	1	22uF	Capacitor, Ceramic Chip, 10V, X5R, ±20%	603	C1608X5R1A226M080AC	TDK		
C9	1	1.0uF	Capacitor, Ceramic Chip, 25V, X5R, ±10%	402	C1005X5R0J105K050BB	TDK		
D1	1	LTST-C190GKT	Diode, LED, Green, 2.1-V, 20-mA, 6-mcd	603	LTST-C190GKT	Lite On		
D2	1	LTST-C190CKT	Diode, LED, Red, 2.1-V, 20-mA, 6-mcd	603	LTST-C190CKT	Lite On		
J1, J7, J9, J11	4	ED555/2DS	Terminal Block, 2-pin, 6-A, 3.5mm	0.27 x 0.25 inch	ED555/2DS	OST		
J2	1	ZX62D-AB-5P8	Connector, USB Micro, Type AB	0.315 X 0.200 inch	ZX62D-AB-5P8	Hirose		
J3, J4, J5, J6, J8, J10, JP2, JP3	8	PEC02SAAN	Header, Male 2-pin, 100mil spacing,	0.100 inch x 2	PEC02SAAN	Sullins		
J12	1	N2510-6002RB	Connector, Male Straight 2x5 pin, 100mil spacing, 4 Wall	0.338 x 0.788 inch	N2510-6002RB	3M		
JP4, JP5, JP6	3	PEC03SAAN	Header, Male 3-pin, 100mil spacing,	0.100 inch x 3	PEC03SAAN	Sullins		
L1	1	1.5 uH	Inductor, High Current, 3.5A, 70 milliohm	4.20x 4.20 mm	SPM4012T-1R5M	TDK	FSD0415-H-1R5M	TOKO
LBL1	1		Thermal Transfer Printable Labels, 0.650" W x 0.200" H - 10,000 per roll	PCB Label 0.650"H x 0.200"W	THT-14-423-10	Brady	-	-
R1, R2	2	200	RES, 200 ohm, 1%, 0.1W, 0603	0603	CRCW0603200RFKEA	Vishay-Dale		
R3, R4	2	1.50k	RES, 1.50k ohm, 1%, 0.1W, 0603	0603	RC0603FR-071K5L	Yageo America		
R5	1	5.62k	RES, 5.62k ohm, 1%, 0.063W, 0402	0402	CRCW04025K62FKED	Vishay-Dale		
R6	1	12.4k	RES, 12.4k ohm, 1%, 0.063W, 0402	0402	CRCW040212K4FKED	Vishay-Dale		
R7	1	50K	Potentiometer, 3/8 Cermet, Single-Turn	0.25x0.17 inch	3266W-1-503LF	Bourns		
SH-JP2, SH-JP3, SH-JP4, SH-JP5, SH-JP6	5	1x2	Shunt, 100mil, Gold plated, Black	Shunt	969102-0000-DA	3M	SNT-100-BK-G	Samtec
TP1, TP2, TP3, TP4, TP5, TP6, TP7, TP8, TP9, TP10, TP11	11	5002	Test Point, White, Thru Hole Color Keyed	0.100 x 0.100 inch	5002	Keystone		
U1	1	BQ24187YFF	IC, 2a, 30v Host-Controlled Single Input, Single Cell Switche Mode	YFF0036ADAD	bq24187YFF	Texas Instruments		None
C6	0	Open	Capacitor, Ceramic Chip, xxV, ±10%	1210	STD	STD		
C8	0	Open	Capacitor, Ceramic Chip, xxV, ±10%	805	STD	STD		
FID1, FID2, FID3	0		Fiducial mark. There is nothing to buy or mount.	Fiducial	N/A	N/A		
JP1	0	PEC02SAAN	Header, Male 2-pin, 100mil spacing,	0.100 inch x 2	PEC02SAAN	Sullins		
R9	0	0	RES, 0 ohm, 5%, 0.063W, 0402	0402	CRCW04020000Z0ED	Vishay-Dale		
SH-JP1	0	1x2	Shunt, 100mil, Gold plated, Black	Shunt	969102-0000-DA	3M	SNT-100-BK-G	Samtec

4.2 Board Layout

Figure 6 through Figure 10 show the bq24187EVM-625 Rev A PCB layouts.

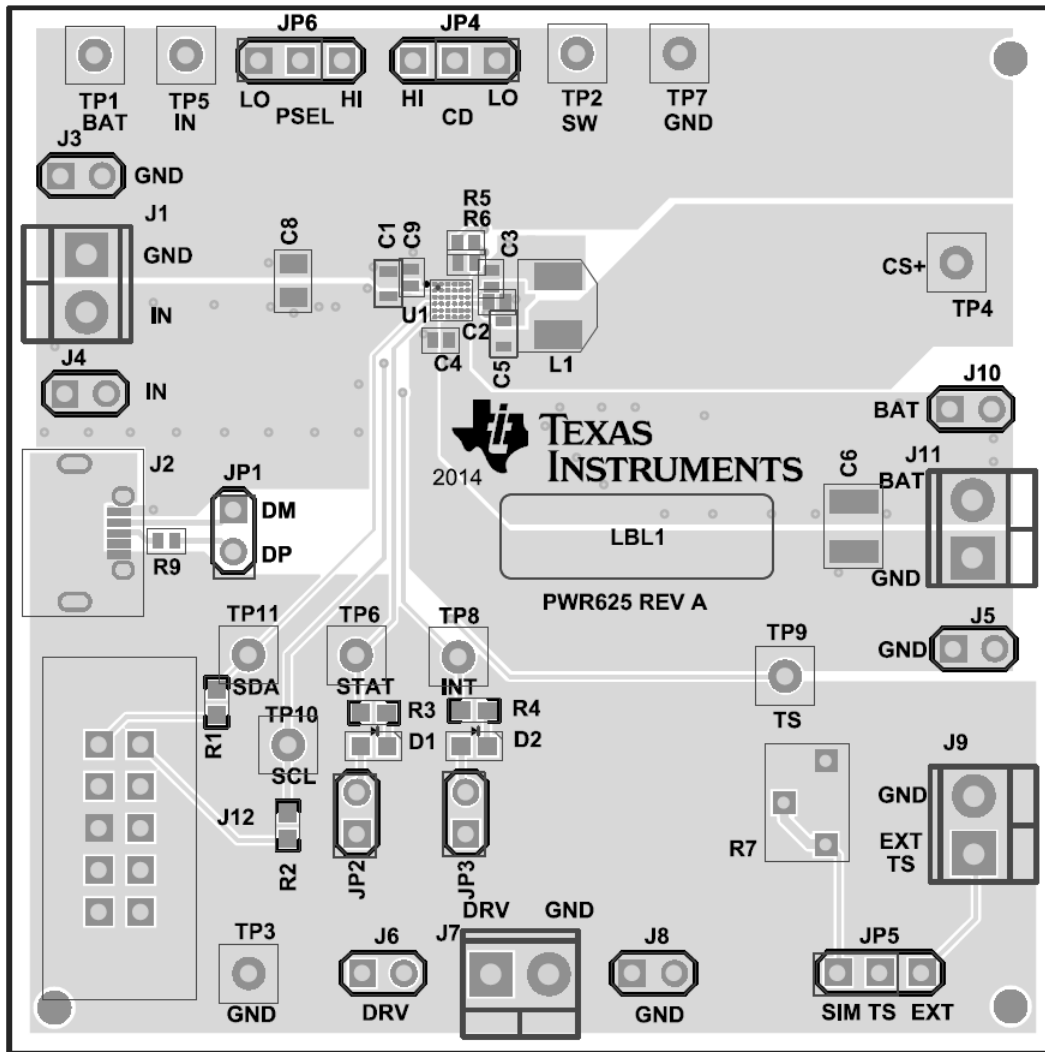

Figure 6. Top Assembly Layer

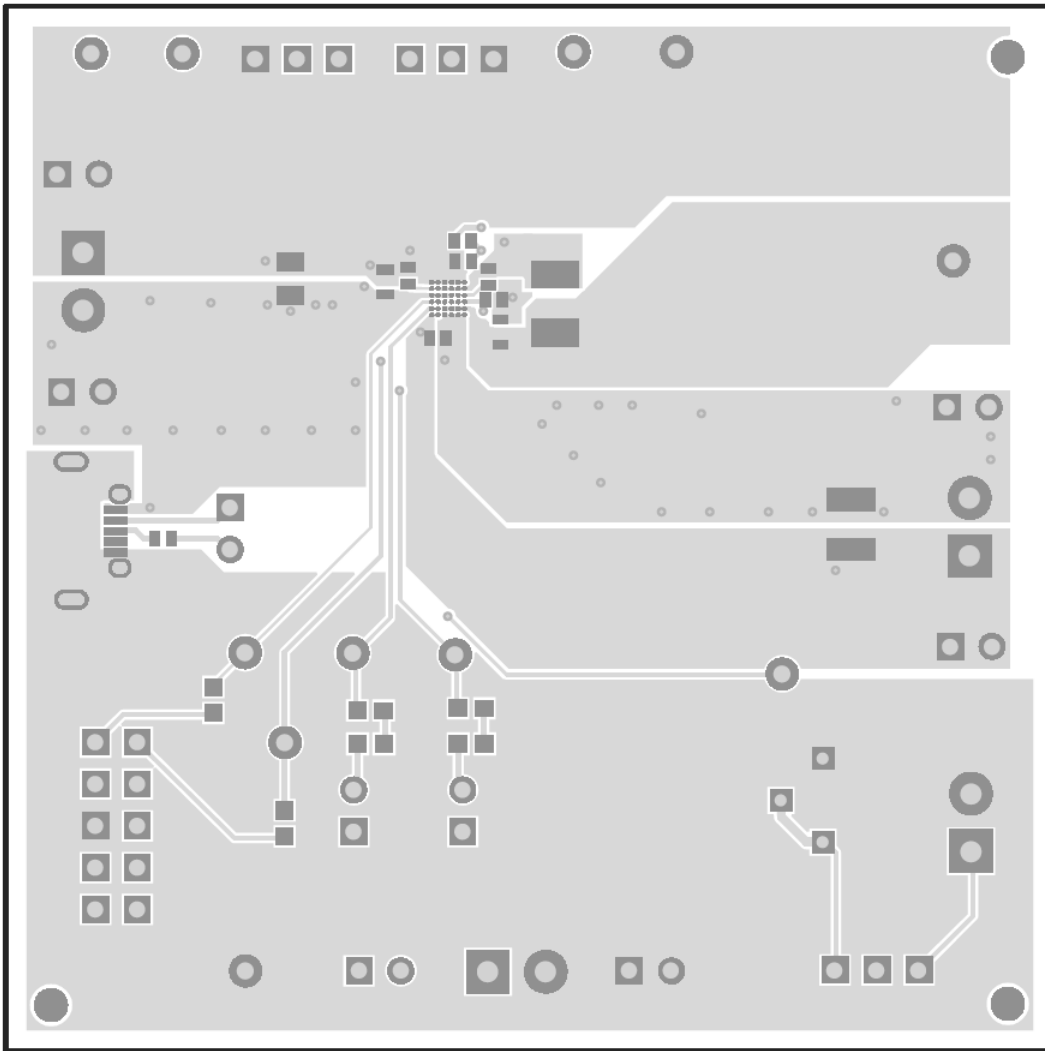

Figure 7. Top Layer

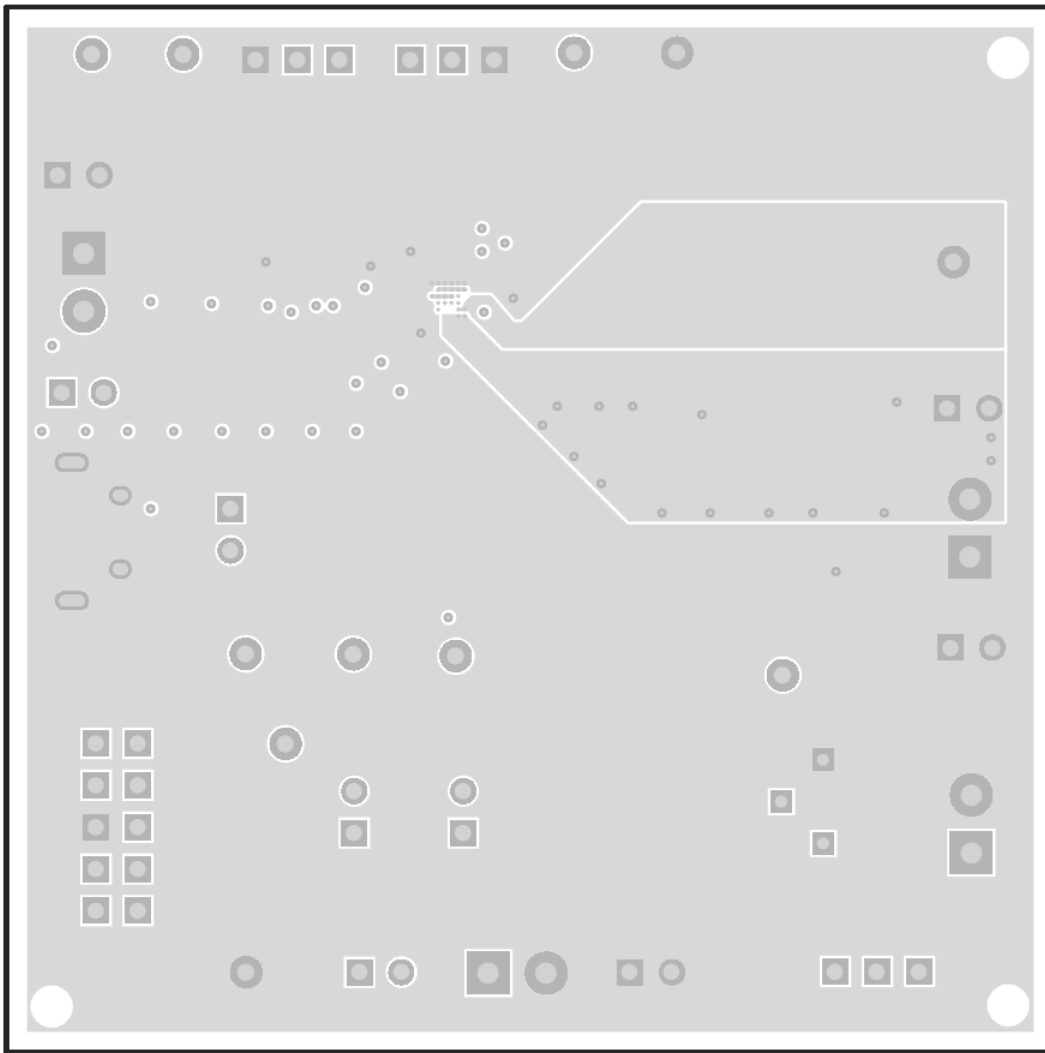

Figure 8. First Internal Layer

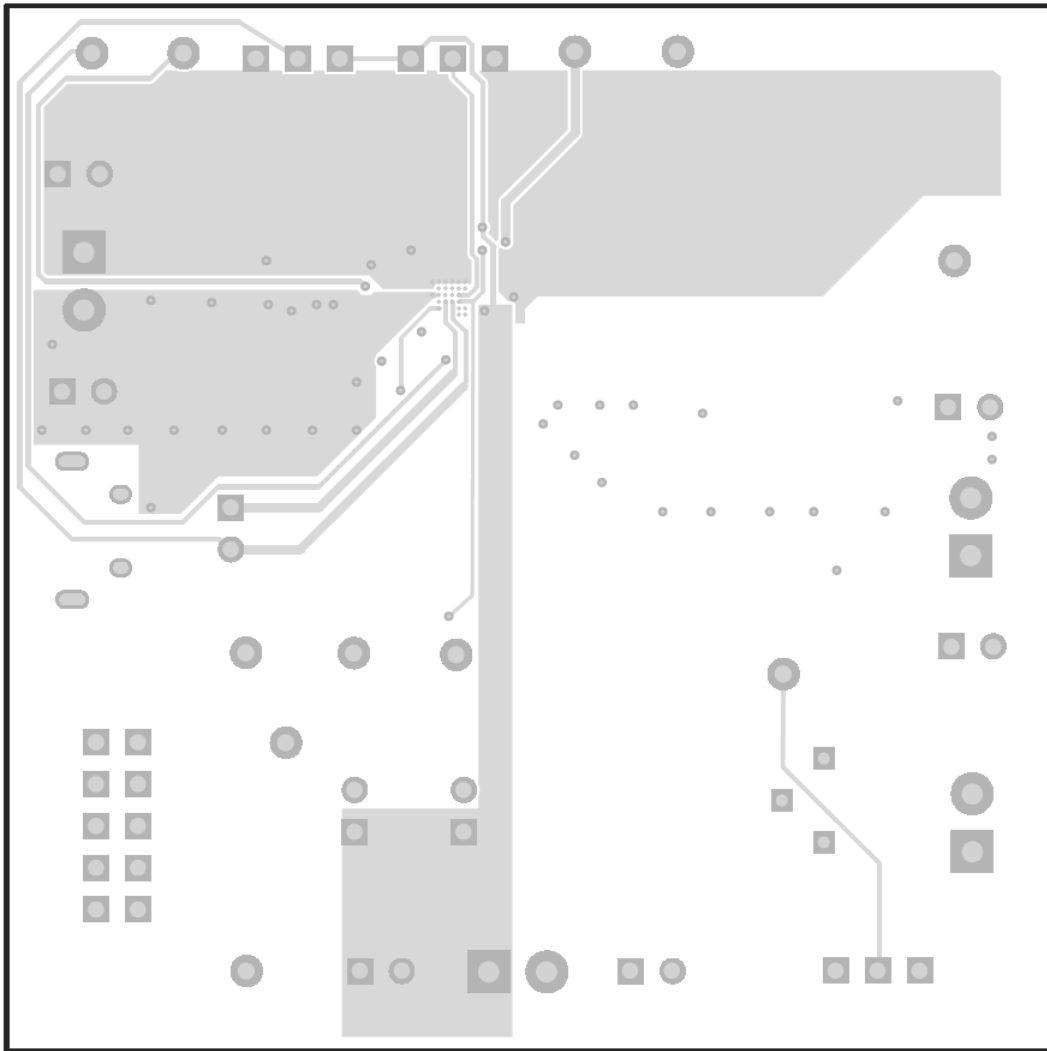

Figure 9. Second Internal Layer

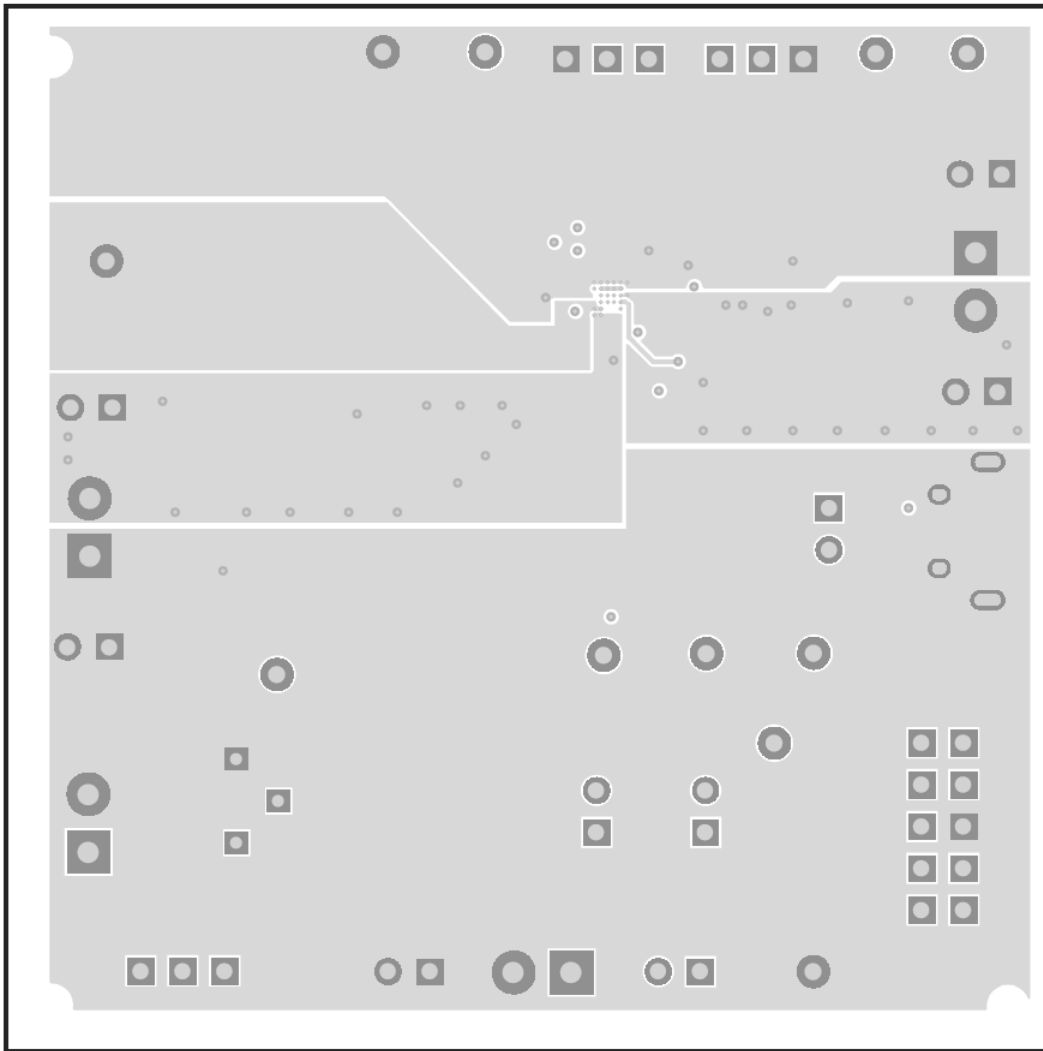

Figure 10. Bottom Layer

ADDITIONAL TERMS AND CONDITIONS, WARNINGS, RESTRICTIONS, AND DISCLAIMERS FOR EVALUATION MODULES

Texas Instruments Incorporated (TI) markets, sells, and loans all evaluation boards, kits, and/or modules (EVMs) pursuant to, and user expressly acknowledges, represents, and agrees, and takes sole responsibility and risk with respect to, the following:

1. User agrees and acknowledges that EVMs are intended to be handled and used for feasibility evaluation only in laboratory and/or development environments. Notwithstanding the foregoing, in certain instances, TI makes certain EVMs available to users that do not handle and use EVMs solely for feasibility evaluation only in laboratory and/or development environments, but may use EVMs in a hobbyist environment. All EVMs made available to hobbyist users are FCC certified, as applicable. Hobbyist users acknowledge, agree, and shall comply with all applicable terms, conditions, warnings, and restrictions in this document and are subject to the disclaimer and indemnity provisions included in this document.
2. Unless otherwise indicated, EVMs are not finished products and not intended for consumer use. EVMs are intended solely for use by technically qualified electronics experts who are familiar with the dangers and application risks associated with handling electrical mechanical components, systems, and subsystems.
3. User agrees that EVMs shall not be used as, or incorporated into, all or any part of a finished product.
4. User agrees and acknowledges that certain EVMs may not be designed or manufactured by TI.
5. User must read the user's guide and all other documentation accompanying EVMs, including without limitation any warning or restriction notices, prior to handling and/or using EVMs. Such notices contain important safety information related to, for example, temperatures and voltages. For additional information on TI's environmental and/or safety programs, please visit www.ti.com/esh or contact TI.
6. User assumes all responsibility, obligation, and any corresponding liability for proper and safe handling and use of EVMs.
7. Should any EVM not meet the specifications indicated in the user's guide or other documentation accompanying such EVM, the EVM may be returned to TI within 30 days from the date of delivery for a full refund. THE FOREGOING LIMITED WARRANTY IS THE EXCLUSIVE WARRANTY MADE BY TI TO USER AND IS IN LIEU OF ALL OTHER WARRANTIES, EXPRESSED, IMPLIED, OR STATUTORY, INCLUDING ANY WARRANTY OF MERCHANTABILITY OR FITNESS FOR ANY PARTICULAR PURPOSE. TI SHALL NOT BE LIABLE TO USER FOR ANY INDIRECT, SPECIAL, INCIDENTAL, OR CONSEQUENTIAL DAMAGES RELATED TO THE HANDLING OR USE OF ANY EVM.
8. No license is granted under any patent right or other intellectual property right of TI covering or relating to any machine, process, or combination in which EVMs might be or are used. TI currently deals with a variety of customers, and therefore TI's arrangement with the user is not exclusive. TI assumes no liability for applications assistance, customer product design, software performance, or infringement of patents or services with respect to the handling or use of EVMs.
9. User assumes sole responsibility to determine whether EVMs may be subject to any applicable federal, state, or local laws and regulatory requirements (including but not limited to U.S. Food and Drug Administration regulations, if applicable) related to its handling and use of EVMs and, if applicable, compliance in all respects with such laws and regulations.
10. User has sole responsibility to ensure the safety of any activities to be conducted by it and its employees, affiliates, contractors or designees, with respect to handling and using EVMs. Further, user is responsible to ensure that any interfaces (electronic and/or mechanical) between EVMs and any human body are designed with suitable isolation and means to safely limit accessible leakage currents to minimize the risk of electrical shock hazard.
11. User shall employ reasonable safeguards to ensure that user's use of EVMs will not result in any property damage, injury or death, even if EVMs should fail to perform as described or expected.
12. User shall be solely responsible for proper disposal and recycling of EVMs consistent with all applicable federal, state, and local requirements.

Certain Instructions. User shall operate EVMs within TI's recommended specifications and environmental considerations per the user's guide, accompanying documentation, and any other applicable requirements. Exceeding the specified ratings (including but not limited to input and output voltage, current, power, and environmental ranges) for EVMs may cause property damage, personal injury or death. If there are questions concerning these ratings, user should contact a TI field representative prior to connecting interface electronics including input power and intended loads. Any loads applied outside of the specified output range may result in unintended and/or inaccurate operation and/or possible permanent damage to the EVM and/or interface electronics. Please consult the applicable EVM user's guide prior to connecting any load to the EVM output. If there is uncertainty as to the load specification, please contact a TI field representative. During normal operation, some circuit components may have case temperatures greater than 60°C as long as the input and output are maintained at a normal ambient operating temperature. These components include but are not limited to linear regulators, switching transistors, pass transistors, and current sense resistors which can be identified using EVMs' schematics located in the applicable EVM user's guide. When placing measurement probes near EVMs during normal operation, please be aware that EVMs may become very warm. As with all electronic evaluation tools, only qualified personnel knowledgeable in electronic measurement and diagnostics normally found in development environments should use EVMs.

Agreement to Defend, Indemnify and Hold Harmless. User agrees to defend, indemnify, and hold TI, its directors, officers, employees, agents, representatives, affiliates, licensors and their representatives harmless from and against any and all claims, damages, losses, expenses, costs and liabilities (collectively, "Claims") arising out of, or in connection with, any handling and/or use of EVMs. User's indemnity shall apply whether Claims arise under law of tort or contract or any other legal theory, and even if EVMs fail to perform as described or expected.

Safety-Critical or Life-Critical Applications. If user intends to use EVMs in evaluations of safety critical applications (such as life support), and a failure of a TI product considered for purchase by user for use in user's product would reasonably be expected to cause severe personal injury or death such as devices which are classified as FDA Class III or similar classification, then user must specifically notify TI of such intent and enter into a separate Assurance and Indemnity Agreement.

RADIO FREQUENCY REGULATORY COMPLIANCE INFORMATION FOR EVALUATION MODULES

Texas Instruments Incorporated (TI) evaluation boards, kits, and/or modules (EVMs) and/or accompanying hardware that is marketed, sold, or loaned to users may or may not be subject to radio frequency regulations in specific countries.

General Statement for EVMs Not Including a Radio

For EVMs not including a radio and not subject to the U.S. Federal Communications Commission (FCC) or Industry Canada (IC) regulations, TI intends EVMs to be used only for engineering development, demonstration, or evaluation purposes. EVMs are not finished products typically fit for general consumer use. EVMs may nonetheless generate, use, or radiate radio frequency energy, but have not been tested for compliance with the limits of computing devices pursuant to part 15 of FCC or the ICES-003 rules. Operation of such EVMs may cause interference with radio communications, in which case the user at his own expense will be required to take whatever measures may be required to correct this interference.

General Statement for EVMs including a radio

User Power/Frequency Use Obligations: For EVMs including a radio, the radio included in such EVMs is intended for development and/or professional use only in legally allocated frequency and power limits. Any use of radio frequencies and/or power availability in such EVMs and their development application(s) must comply with local laws governing radio spectrum allocation and power limits for such EVMs. It is the user's sole responsibility to only operate this radio in legally acceptable frequency space and within legally mandated power limitations. Any exceptions to this are strictly prohibited and unauthorized by TI unless user has obtained appropriate experimental and/or development licenses from local regulatory authorities, which is the sole responsibility of the user, including its acceptable authorization.

U.S. Federal Communications Commission Compliance

For EVMs Annotated as FCC – FEDERAL COMMUNICATIONS COMMISSION Part 15 Compliant

Caution

This device complies with part 15 of the FCC Rules. Operation is subject to the following two conditions: (1) This device may not cause harmful interference, and (2) this device must accept any interference received, including interference that may cause undesired operation. Changes or modifications could void the user's authority to operate the equipment.

FCC Interference Statement for Class A EVM devices

This equipment has been tested and found to comply with the limits for a Class A digital device, pursuant to part 15 of the FCC Rules. These limits are designed to provide reasonable protection against harmful interference when the equipment is operated in a commercial environment. This equipment generates, uses, and can radiate radio frequency energy and, if not installed and used in accordance with the instruction manual, may cause harmful interference to radio communications. Operation of this equipment in a residential area is likely to cause harmful interference in which case the user will be required to correct the interference at its own expense.

FCC Interference Statement for Class B EVM devices

This equipment has been tested and found to comply with the limits for a Class B digital device, pursuant to part 15 of the FCC Rules. These limits are designed to provide reasonable protection against harmful interference in a residential installation. This equipment generates, uses and can radiate radio frequency energy and, if not installed and used in accordance with the instructions, may cause harmful interference to radio communications. However, there is no guarantee that interference will not occur in a particular installation. If this equipment does cause harmful interference to radio or television reception, which can be determined by turning the equipment off and on, the user is encouraged to try to correct the interference by one or more of the following measures:

- Reorient or relocate the receiving antenna.
- Increase the separation between the equipment and receiver.
- Connect the equipment into an outlet on a circuit different from that to which the receiver is connected.
- Consult the dealer or an experienced radio/TV technician for help.

Industry Canada Compliance (English)

For EVMs Annotated as IC – INDUSTRY CANADA Compliant:

This Class A or B digital apparatus complies with Canadian ICES-003.

Changes or modifications not expressly approved by the party responsible for compliance could void the user's authority to operate the equipment.

Concerning EVMs Including Radio Transmitters

This device complies with Industry Canada licence-exempt RSS standard(s). Operation is subject to the following two conditions: (1) this device may not cause interference, and (2) this device must accept any interference, including interference that may cause undesired operation of the device.

Concerning EVMs Including Detachable Antennas

Under Industry Canada regulations, this radio transmitter may only operate using an antenna of a type and maximum (or lesser) gain approved for the transmitter by Industry Canada. To reduce potential radio interference to other users, the antenna type and its gain should be so chosen that the equivalent isotropically radiated power (e.i.r.p.) is not more than that necessary for successful communication.

This radio transmitter has been approved by Industry Canada to operate with the antenna types listed in the user guide with the maximum permissible gain and required antenna impedance for each antenna type indicated. Antenna types not included in this list, having a gain greater than the maximum gain indicated for that type, are strictly prohibited for use with this device.

Canada Industry Canada Compliance (French)

Cet appareil numérique de la classe A ou B est conforme à la norme NMB-003 du Canada

Les changements ou les modifications pas expressément approuvés par la partie responsable de la conformité ont pu vider l'autorité de l'utilisateur pour actionner l'équipement.

Concernant les EVMs avec appareils radio

Le présent appareil est conforme aux CNR d'Industrie Canada applicables aux appareils radio exempts de licence. L'exploitation est autorisée aux deux conditions suivantes : (1) l'appareil ne doit pas produire de brouillage, et (2) l'utilisateur de l'appareil doit accepter tout brouillage radioélectrique subi, même si le brouillage est susceptible d'en compromettre le fonctionnement.

Concernant les EVMs avec antennes détachables

Conformément à la réglementation d'Industrie Canada, le présent émetteur radio peut fonctionner avec une antenne d'un type et d'un gain maximal (ou inférieur) approuvé pour l'émetteur par Industrie Canada. Dans le but de réduire les risques de brouillage radioélectrique à l'intention des autres utilisateurs, il faut choisir le type d'antenne et son gain de sorte que la puissance isotrope rayonnée équivalente (p.i.r.e.) ne dépasse pas l'intensité nécessaire à l'établissement d'une communication satisfaisante.

Le présent émetteur radio a été approuvé par Industrie Canada pour fonctionner avec les types d'antenne énumérés dans le manuel d'usage et ayant un gain admissible maximal et l'impédance requise pour chaque type d'antenne. Les types d'antenne non inclus dans cette liste, ou dont le gain est supérieur au gain maximal indiqué, sont strictement interdits pour l'exploitation de l'émetteur.

Mailing Address: Texas Instruments, Post Office Box 655303, Dallas, Texas 75265
Copyright © 2014, Texas Instruments Incorporated

Important Notice for Users of EVMs Considered “Radio Frequency Products” in Japan

EVMs entering Japan are NOT certified by TI as conforming to Technical Regulations of Radio Law of Japan.

If user uses EVMs in Japan, user is required by Radio Law of Japan to follow the instructions below with respect to EVMs:

1. Use EVMs in a shielded room or any other test facility as defined in the notification #173 issued by Ministry of Internal Affairs and Communications on March 28, 2006, based on Sub-section 1.1 of Article 6 of the Ministry's Rule for Enforcement of Radio Law of Japan,
2. Use EVMs only after user obtains the license of Test Radio Station as provided in Radio Law of Japan with respect to EVMs, or
3. Use of EVMs only after user obtains the Technical Regulations Conformity Certification as provided in Radio Law of Japan with respect to EVMs. Also, do not transfer EVMs, unless user gives the same notice above to the transferee. Please note that if user does not follow the instructions above, user will be subject to penalties of Radio Law of Japan.

<http://www.tij.co.jp>

【無線電波を送信する製品の開発キットをお使いになる際の注意事項】本開発キットは技術基準適合証明を受けておりません。本製品のご使用に際しては、電波法遵守のため、以下のいずれかの措置を取っていただく必要がありますのでご注意ください。

1. 電波法施行規則第6条第1項第1号に基づく平成18年3月28日総務省告示第173号で定められた電波暗室等の試験設備でご使用いただく。
2. 実験局の免許を取得後ご使用いただく。
3. 技術基準適合証明を取得後ご使用いただく。。

なお、本製品は、上記の「ご使用にあたっての注意」を譲渡先、移転先に通知しない限り、譲渡、移転できないものとします

上記を遵守頂けない場合は、電波法の罰則が適用される可能性があることをご留意ください。

日本テキサス・インスツルメンツ株式会社

東京都新宿区西新宿6丁目24番1号

西新宿三井ビル

<http://www.tij.co.jp>

Texas Instruments Japan Limited

(address) 24-1, Nishi-Shinjuku 6 chome, Shinjuku-ku, Tokyo, Japan

IMPORTANT NOTICE

Texas Instruments Incorporated and its subsidiaries (TI) reserve the right to make corrections, enhancements, improvements and other changes to its semiconductor products and services per JESD46, latest issue, and to discontinue any product or service per JESD48, latest issue. Buyers should obtain the latest relevant information before placing orders and should verify that such information is current and complete. All semiconductor products (also referred to herein as "components") are sold subject to TI's terms and conditions of sale supplied at the time of order acknowledgment.

TI warrants performance of its components to the specifications applicable at the time of sale, in accordance with the warranty in TI's terms and conditions of sale of semiconductor products. Testing and other quality control techniques are used to the extent TI deems necessary to support this warranty. Except where mandated by applicable law, testing of all parameters of each component is not necessarily performed.

TI assumes no liability for applications assistance or the design of Buyers' products. Buyers are responsible for their products and applications using TI components. To minimize the risks associated with Buyers' products and applications, Buyers should provide adequate design and operating safeguards.

TI does not warrant or represent that any license, either express or implied, is granted under any patent right, copyright, mask work right, or other intellectual property right relating to any combination, machine, or process in which TI components or services are used. Information published by TI regarding third-party products or services does not constitute a license to use such products or services or a warranty or endorsement thereof. Use of such information may require a license from a third party under the patents or other intellectual property of the third party, or a license from TI under the patents or other intellectual property of TI.

Reproduction of significant portions of TI information in TI data books or data sheets is permissible only if reproduction is without alteration and is accompanied by all associated warranties, conditions, limitations, and notices. TI is not responsible or liable for such altered documentation. Information of third parties may be subject to additional restrictions.

Resale of TI components or services with statements different from or beyond the parameters stated by TI for that component or service voids all express and any implied warranties for the associated TI component or service and is an unfair and deceptive business practice. TI is not responsible or liable for any such statements.

Buyer acknowledges and agrees that it is solely responsible for compliance with all legal, regulatory and safety-related requirements concerning its products, and any use of TI components in its applications, notwithstanding any applications-related information or support that may be provided by TI. Buyer represents and agrees that it has all the necessary expertise to create and implement safeguards which anticipate dangerous consequences of failures, monitor failures and their consequences, lessen the likelihood of failures that might cause harm and take appropriate remedial actions. Buyer will fully indemnify TI and its representatives against any damages arising out of the use of any TI components in safety-critical applications.

In some cases, TI components may be promoted specifically to facilitate safety-related applications. With such components, TI's goal is to help enable customers to design and create their own end-product solutions that meet applicable functional safety standards and requirements. Nonetheless, such components are subject to these terms.

No TI components are authorized for use in FDA Class III (or similar life-critical medical equipment) unless authorized officers of the parties have executed a special agreement specifically governing such use.

Only those TI components which TI has specifically designated as military grade or "enhanced plastic" are designed and intended for use in military/aerospace applications or environments. Buyer acknowledges and agrees that any military or aerospace use of TI components which have **not** been so designated is solely at the Buyer's risk, and that Buyer is solely responsible for compliance with all legal and regulatory requirements in connection with such use.

TI has specifically designated certain components as meeting ISO/TS16949 requirements, mainly for automotive use. In any case of use of non-designated products, TI will not be responsible for any failure to meet ISO/TS16949.

Products

Audio	www.ti.com/audio
Amplifiers	amplifier.ti.com
Data Converters	dataconverter.ti.com
DLP® Products	www.dlp.com
DSP	dsp.ti.com
Clocks and Timers	www.ti.com/clocks
Interface	interface.ti.com
Logic	logic.ti.com
Power Mgmt	power.ti.com
Microcontrollers	microcontroller.ti.com
RFID	www.ti-rfid.com
OMAP Applications Processors	www.ti.com/omap
Wireless Connectivity	www.ti.com/wirelessconnectivity

Applications

Automotive and Transportation	www.ti.com/automotive
Communications and Telecom	www.ti.com/communications
Computers and Peripherals	www.ti.com/computers
Consumer Electronics	www.ti.com/consumer-apps
Energy and Lighting	www.ti.com/energy
Industrial	www.ti.com/industrial
Medical	www.ti.com/medical
Security	www.ti.com/security
Space, Avionics and Defense	www.ti.com/space-avionics-defense
Video and Imaging	www.ti.com/video

TI E2E Community

e2e.ti.com