



### FEATURES

- Patent protected
- UL60950 recognised
- Footprint over pins 0.69cm<sup>2</sup>
- Single & dual isolated output
- 1kVDC isolation “Hi Pot Test”
- Efficiency up to 88% (Typ.)
- MSL level 1
- Power density 1.71W/cm<sup>3</sup>
- Wide temperature performance at full 1 Watt load, -40°C to 85°C
- UL 94V-0 package material
- 5V & 12V inputs
- 5V, 9V, 12V & 15V single & dual outputs
- Toroidal magnetics
- Custom solutions available
- Multi-layer ceramic capacitors

### PRODUCT OVERVIEW

The MTU1 series is a new range of miniature surface mount, high performance 1W DC-DC converters. With a footprint reduction of over 50% from the previous generation of 1W SMD DC-DC, the MTU1 series offers 1W of available output power over the full industrial temperature range of -40°C to 85°C. The MTU1 series is more efficient and offers improved regulation performance for applications where a wide output voltage variation can not be tolerated.

The devices are suitable for all applications where high volume production is envisaged.



For full details go to  
<https://www.murata.com/en-global/products/power/rohs>



### SELECTION GUIDE

Order Code <sup>1</sup>	Nominal Input Voltage	Output Voltage	Output Current	Load Regulation (Typ.)	Load Regulation (Max)	Ripple & Noise (Typ.) <sup>3</sup>	Ripple & Noise (Max.) <sup>2</sup>	Input Current at Full Load	Efficiency (Min.)	Efficiency (Typ.)	Isolation Capacitance	MTTF <sup>2</sup>	Recommended Alternative
	V	V	mA	%	%	mVp-p	mVp-p	mA	%	%	pF	kHrs	
<span style="border: 1px solid green; padding: 2px;">Recommended</span> <span style="border: 1px solid blue; padding: 2px; margin-left: 10px;">In Production</span>													
MTU1S0505MC	5	5	200	7.3	9	35	60	241	80	83	19	5664	
MTU1S0509MC	5	9	111	6.1	7.5	15	25	233	83	86	20	5488	
MTU1S0512MC	5	12	83	5.6	7.5	15	25	230	84	87	21	5186	
MTU1S0515MC	5	15	67	5.3	6.5	15	25	230	84	87	22	4773	
MTU1S1205MC	12	5	200	5.6	8	20	40	99	80	84	22	5641	
MTU1D0509MC	5	±9	±56	5.6	6.5	7	20	229	83	86	21	5078	
MTU1D1212MC	12	±12	±42	3.0	4	8	20	94	84	88	35	4834	
<b>Discontinued</b>													
MTU1D0305MC	3.3	±5	±100	8.0	9.5	18	35	356	80	83	17	5292	NKA0305SC
MTU1S0305MC	3.3	5	200	8.9	11.0	26	60	367	79	81	14	7660	NXE1S0305MC
MTU1D0505MC	5	±5	±100	6.6	8	14	30	235	81	84	18	5053	NTA0505MC
MTU1D0512MC	5	±12	±42	5.0	6	8	20	228	83	87	19	5545	NKA0512SC
MTU1D0515MC	5	±15	±33	5.1	6.5	8	20	224	84	88	22	5293	NKA0515SC
MTU1D1205MC	12	±5	±100	4.3	5	14	30	98	80	85	18	4335	NKA1205SC
MTU1D1209MC	12	±9	±56	3.1	4	7	20	95	82	87	27	4601	NKA1209SC
MTU1S1209MC	12	9	111	3.9	6	15	25	96	82	87	31	5467	NTE1209MC
MTU1S1212MC	12	12	83	3.5	6	10	25	95	83	88	40	5165	NTE1212MC
MTU1D1215MC	12	±15	±33	2.6	3.5	8	20	94	84	88	35	4782	NKA1215SC
MTU1S1215MC	12	15	67	3.2	5	10	25	95	84	88	35	4753	NTE1215MC

### INPUT CHARACTERISTICS

Parameter	Conditions	Min.	Typ.	Max.	Units
Voltage range	Continuous operation, 3.3V input types	2.97	3.3	3.63	V
	Continuous operation, 5V input types	4.5	5.0	5.5	
	Continuous operation, 12V input types	10.8	12.0	13.2	
Reflected ripple current	Single output types		3.3V input types	10	mA p-p
			5V input types	6	
	Dual output types		12V input types	5	
			All variants	5	

### GENERAL CHARACTERISTICS

Parameter	Conditions	Min.	Typ.	Max.	Units
Switching frequency	MTU1D0305MC		70		kHz
	3.3V & 5V input, all output types (except MTU1D0305MC)		82		
	12V input, single output types		90		
	12V input, dual output types		100		

### OUTPUT CHARACTERISTICS

Parameter	Conditions	Min.	Typ.	Max.	Units
Rated power	T <sub>A</sub> = -40°C to 85°C			1.0	W
Voltage set point accuracy	See tolerance envelope				
Line regulation	High V <sub>IN</sub> to low V <sub>IN</sub>		1.0	1.1	%/%

1. If components are required in tape and reel format suffix order code with -R, e.g. MTU10505MC-R.  
 2. Calculated using MIL-HDBK-217 FN2 calculation model with nominal input voltage at full load.  
 3. See ripple & noise characterisation method.  
 All specifications typical at T<sub>A</sub> = 25°C, nominal input voltage and rated output current unless otherwise specified.

ISOLATION CHARACTERISTICS					
Parameter	Conditions	Min.	Typ.	Max.	Units
Isolation voltage	Flash tested for 1 second	1000			VDC
Resistance	Viso= 1000VDC	10			GΩ

TEMPERATURE CHARACTERISTICS					
Parameter	Conditions	Min.	Typ.	Max.	Units
Specification	All output types (see safety approval section for limitations)	-40		85	°C
Storage		-55		125	
Case temperature rise above ambient <sup>1</sup>	MTU1xxx05MC		15		
	MTU1xxx09MC		14		
	MTU1xxx12MC & MTU1xxx15MC		11		
Cooling	Free air convection				

ABSOLUTE MAXIMUM RATINGS	
Input voltage $V_{IN}$ , MTU1S03 types	5.5V
Input voltage $V_{IN}$ , MTU1S05 types	7V
Input voltage $V_{IN}$ , MTU1S12 types	15V

1. Measured after 1 hour continuous operation at nominal  $V_{IN}$  full load at the center of each PCB.



**CHARACTERISATION TEST METHODS**

**Ripple & Noise Characterisation Method**

Ripple and noise measurements are performed with the following test configuration.

C1	1µF X7R multilayer ceramic capacitor, voltage rating to be a minimum of 3 times the output voltage of the DC-DC converter
C2	10µF tantalum capacitor, voltage rating to be a minimum of 1.5 times the output voltage of the DC-DC converter with an ESR of less than 100mΩ at 100 kHz
C3	100nF multilayer ceramic capacitor, general purpose
R1	450Ω resistor, carbon film, ±1% tolerance
R2	50Ω BNC termination
T1	3T of the coax cable through a ferrite toroid
RLOAD	Resistive load to the maximum power rating of the DC-DC converter. Connections should be made via twisted wires

Measured values are multiplied by 10 to obtain the specified values.

**Differential Mode Noise Test Schematic**

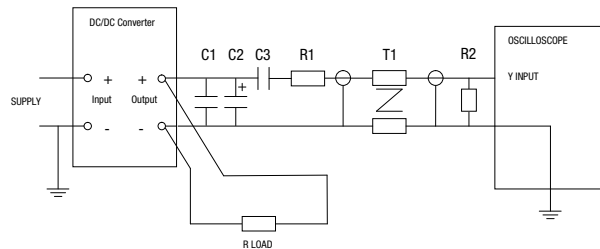

**APPLICATION NOTES**

**Minimum load**

The minimum load to meet datasheet specification is 10% of the full rated load across the specified input voltage range. Lower than 10% minimum loading will result in an increase in output voltage, which may rise to typically double the specified output voltage if the output load falls to less than 5%.

**Capacitive loading and start up**

Typical start up times for this series, with a typical input voltage rise time of 2.2µs and output capacitance of 10µF, are shown in the table below. The product series will start into a capacitance of 47µF with an increased start time, however, the maximum recommended output capacitance is 10µF.

	Start-up time ms		Start-up time ms
MTU1S0305MC	1.7	MTU1D0305MC	3.1
MTU1S0505MC	0.9	MTU1D0505MC	1.8
MTU1S0509MC	2.7	MTU1D0509MC	5.7
MTU1S0512MC	4.3	MTU1D0512MC	10.1
MTU1S0515MC	7.5	MTU1D0515MC	19.1
MTU1S1205MC	0.9	MTU1D1205MC	1.5
MTU1S1209MC	1.9	MTU1D1209MC	4
MTU1S1212MC	3.3	MTU1D1212MC	7.5
MTU1S1215MC	4.7	MTU1D1215MC	12.5

**Typical Start-Up Wave Form**

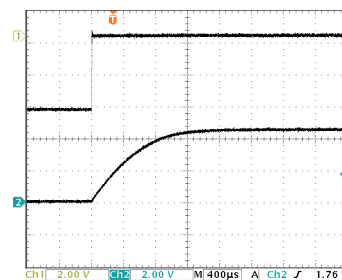

**APPLICATION NOTES (Continued)**

**Output Ripple Reduction**

By using the values of inductance and capacitance stated, the output ripple at the rated load is lowered to 5mV p-p max.

**Component selection**

**Capacitor:** It is required that the ESR (Equivalent Series Resistance) should be as low as possible, ceramic types are recommended. The voltage rating should be at least twice (except for 15V output), the rated output voltage of the DC-DC converter.

**Inductor:** The rated current of the inductor should not be less than that of the output of the DC-DC converter. At the rated current, the DC resistance of the inductor should be such that the voltage drop across the inductor is <2% of the rated voltage of the DC-DC converter. The SRF (Self Resonant Frequency) should be >20MHz.

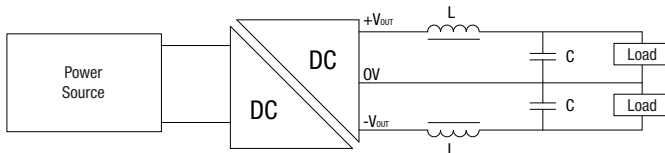

	Inductor			Capacitor
	L, $\mu$ H	SMD	Through Hole	C, $\mu$ F
MTU1S0305MC	10	82103C	11R103C	10
MTU1S0505MC	10	82103C	11R103C	4.7
MTU1S0509MC	22	82223C	11R223C	2.2
MTU1S0512MC	47	82473C	11R473C	1
MTU1S0515MC	47	82473C	11R473C	1
MTU1S1205MC	10	82103C	11R103C	4.7
MTU1S1209MC	22	82223C	11R223C	2.2
MTU1S1212MC	47	82473C	11R473C	1
MTU1S1215MC	47	82473C	11R473C	1
MTU1D0305MC	10	82103C	11R103C	10
MTU1D0505MC	10	82103C	11R103C	4.7
MTU1D0509MC	22	82223C	11R223C	2.2
MTU1D0512MC	47	82473C	11R473C	1
MTU1D0515MC	47	82473C	11R473C	1
MTU1D1205MC	10	82103C	11R103C	4.7
MTU1D1209MC	22	82223C	11R223C	2.2
MTU1D1212MC	47	82473C	11R473C	1
MTU1D1215MC	47	82473C	11R473C	1

**TOLERANCE ENVELOPES**

The voltage tolerance envelopes show typical load regulation characteristics for this product series. The tolerance envelope is the maximum output voltage variation due to changes in output loading and set point accuracy.

**3.3V Input Types**

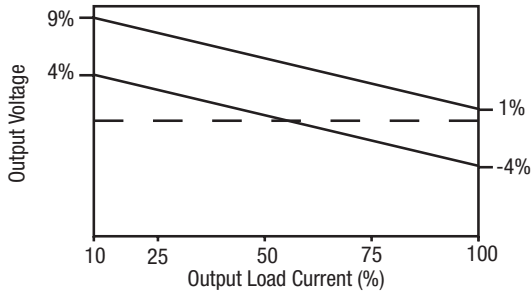

**Single 5V output types (except 3.3V input)**

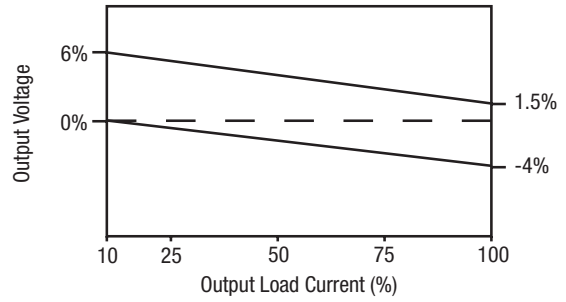

**Dual 5V output types (except 3.3V input)**

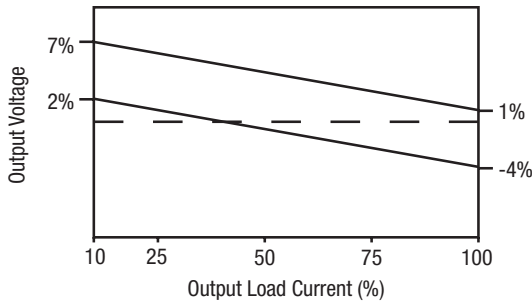

**121505 & 241505**

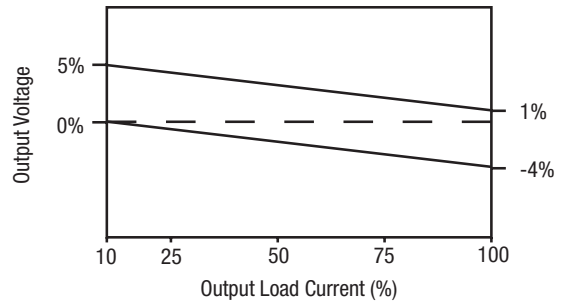

**TEMPERATURE DERATING GRAPH**

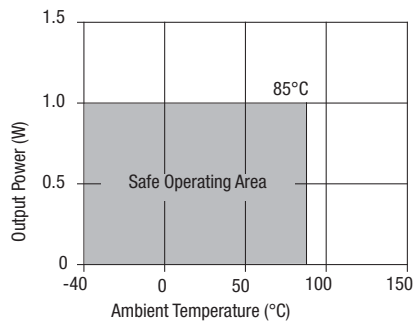

**EFFICIENCY VS LOAD**

**MTU1x03xxMC**

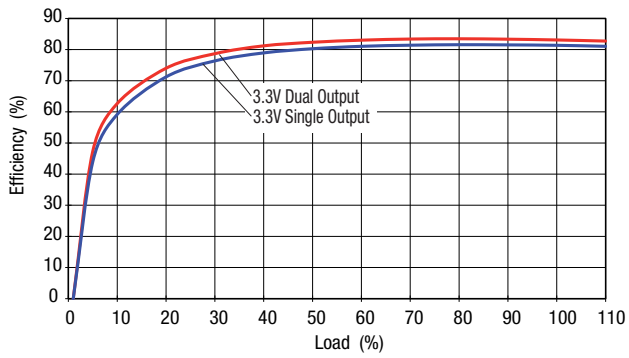

**MTUx05xxMC**

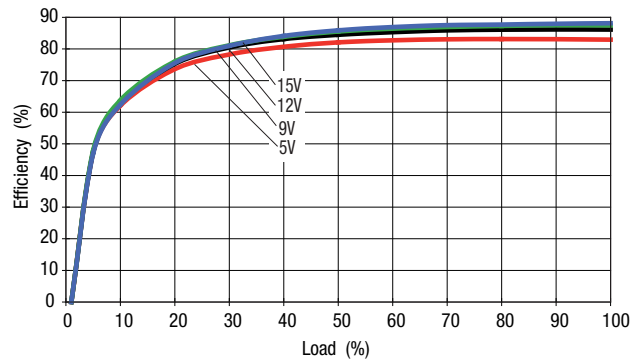

**MTU1x12xxMC**

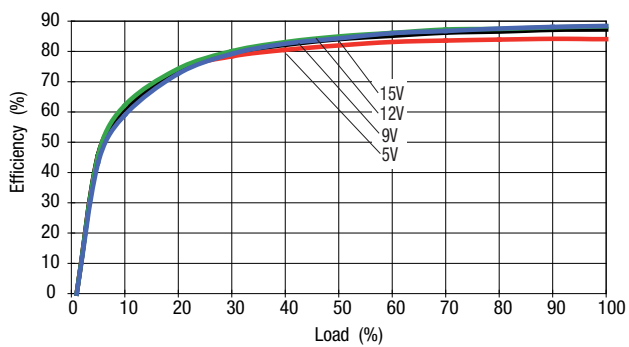

## PACKAGE SPECIFICATIONS

### MECHANICAL DIMENSIONS

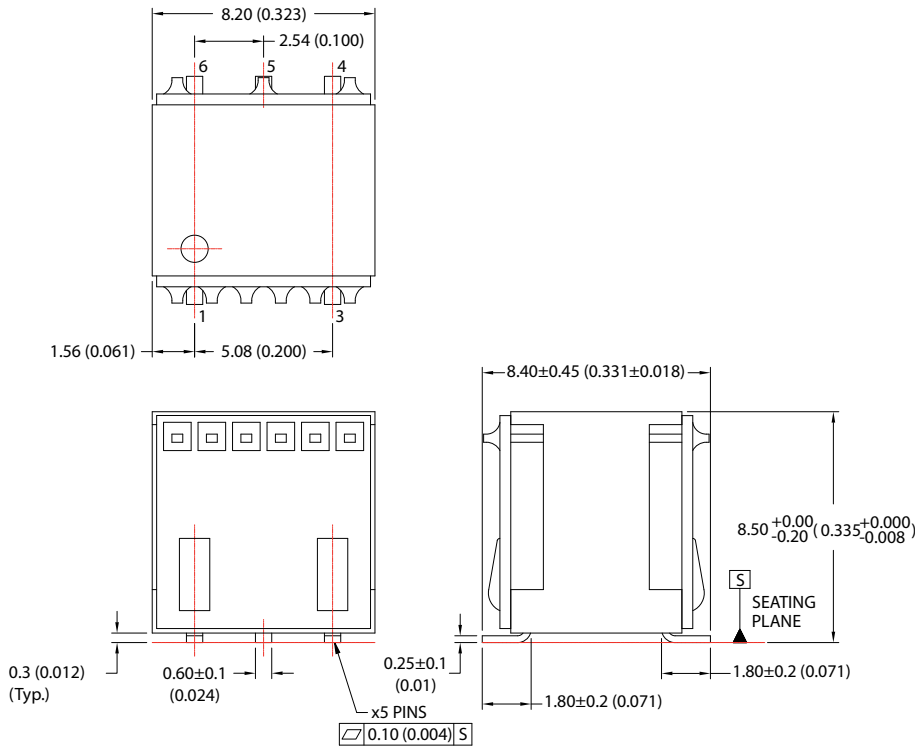

All dimensions in mm  $\pm 0.25$ mm (inches  $\pm 0.01$ ). All pins on a 2.54 (0.1) pitch and within 0.25 (0.01) of true position.

Weight: 0.75g, typ.

### PIN CONNECTIONS

Single Output Types	
Pin	Function
1	+V <sub>IN</sub>
3	-V <sub>IN</sub>
4	NC
5	OV
6	+V <sub>OUT</sub>

Dual Output Types	
Pin	Function
1	+V <sub>IN</sub>
3	-V <sub>IN</sub>
4	-V <sub>OUT</sub>
5	OV
6	+V <sub>OUT</sub>

### RECOMMENDED FOOTPRINT DETAILS

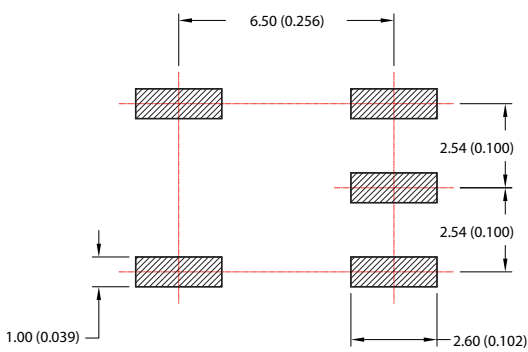

### TUBE OUTLINE DIMENSIONS

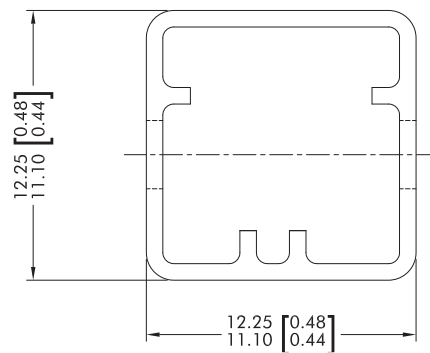

Unless otherwise stated all dimensions in mm (inches).  
Tube length: 520mm (20.472)  $\pm 2.00$  (0.079).

Tube Quantity: 60



**TAPE & REEL SPECIFICATIONS**

**REEL OUTLINE DIMENSIONS**

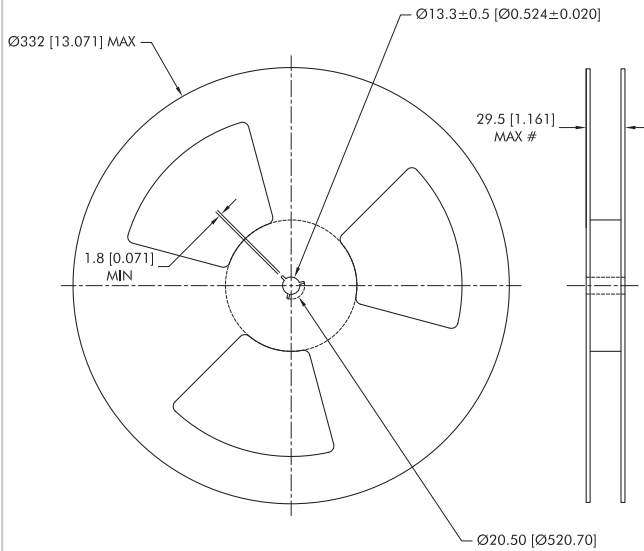

**REEL PACKAGING DETAILS**

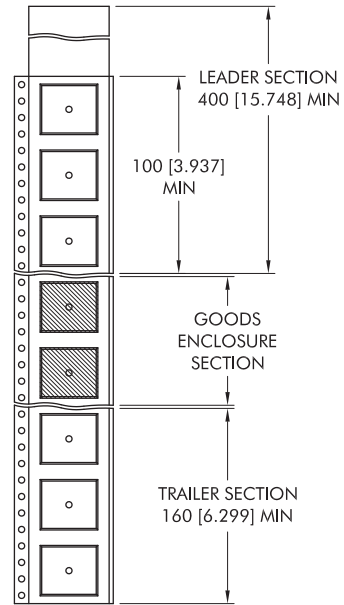

**TAPE OUTLINE DIMENSIONS**

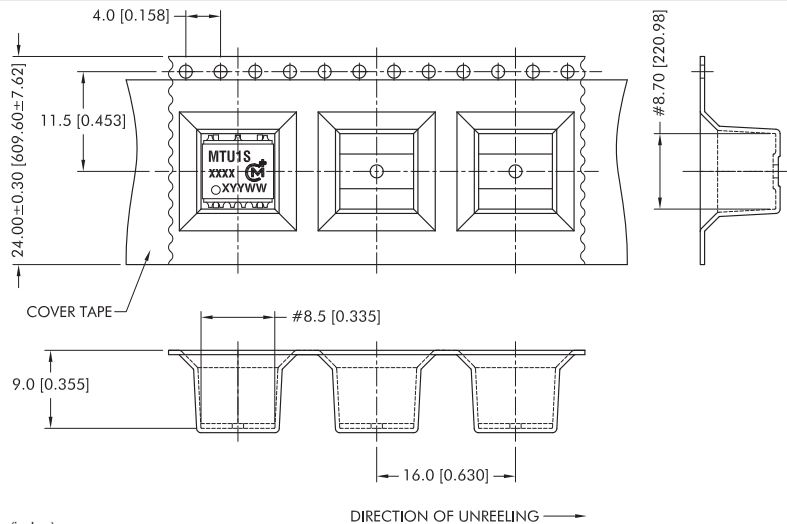

Unless otherwise stated all dimensions in mm (inches).  
Controlling dimension is mm.  
Components shall be orientated within the carrier tape as indicated.

Reel Quantity: 400 pcs.

**DISCLAIMER**

Unless otherwise stated in the datasheet, all products are designed for standard commercial and industrial applications and NOT for safety-critical and/or life-critical applications.

Particularly for safety-critical and/or life-critical applications, i.e. applications that may directly endanger or cause the loss of life, inflict bodily harm and/or loss or severe damage to equipment/property, and severely harm the environment, a prior explicit written approval from Murata is strictly required. Any use of Murata standard products for any safety-critical, life-critical or any related applications without any prior explicit written approval from Murata shall be deemed unauthorised use.

These applications include but are not limited to:

- Aircraft equipment
- Aerospace equipment
- Undersea equipment
- Power plant control equipment
- Medical equipment
- Transportation equipment ( automobiles, trains, ships, etc.)
- Traffic signal equipment
- Disaster prevention / crime prevention equipment
- Data Processing equipment

Murata makes no express or implied warranty, representation, or guarantee of suitability, fitness for any particular use/purpose and/or compatibility with any application or device of the buyer, nor does Murata assume any liability whatsoever arising out of unauthorised use of any Murata product for the application of the buyer. The suitability, fitness for any particular use/purpose and/or compatibility of Murata product with any application or device of the buyer remain to be the responsibility and liability of the buyer.

Buyer represents and agrees that it has all the necessary expertise to create and implement safeguards that anticipate dangerous consequences of failures, monitor failures and their consequences, lessen the likelihood of failures that might cause harm, and take appropriate remedial actions. Buyer will fully indemnify and hold Murata, its affiliated companies, and its representatives harmless against any damages arising out of unauthorised use of any Murata products in any safety-critical and/or life-critical applications.

Remark: Murata in this section refers to Murata Manufacturing Company and its affiliated companies worldwide including, but not limited to, Murata Power Solutions.



This product is subject to the following [operating requirements](https://www.murata.com/en-eu/products/power/requirements) and the [Life and Safety Critical Application Sales Policy](https://www.murata.com/en-eu/products/power/requirements):

Refer to: <https://www.murata.com/en-eu/products/power/requirements>

Murata Power Solutions (Milton Keynes) Ltd. makes no representation that the use of its products in the circuits described herein, or the use of other technical information contained herein, will not infringe upon existing or future patent rights. The descriptions contained herein do not imply the granting of licenses to make, use, or sell equipment constructed in accordance therewith. Specifications are subject to change without notice.

© 2023 Murata Power Solutions (Milton Keynes) Ltd.