

SST-05-IR-850nm

Surface Mount Series

Infrared LED

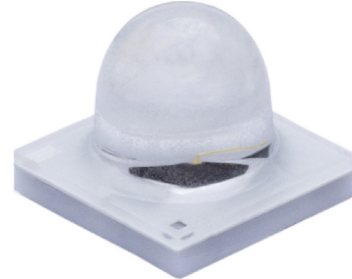

Table of Contents

Technology Overview	2
Product Binning.	3
Ordering Information	3
Optical and Electrical Characteristics	4
B40 - Mech. Dimensions	7
B40 - Tape and Reel.	8
Reel Information	9
Shipping information	10
Soldering	11
Precautions	12
Revision History.	13

Features

- High Power Infrared LED with typical 850nm wavelength
- 20 and 35 degree half-angle dome for high-irradiance and simpler optical design for directional applications
- Operation at up to 1A CW and 2A pulse
- 850nm typical centroid wavelength
- Built-in ESD protection
- Low Thermal Resistance
- Suitable for all SMT Assembly Methods
- RoHS and REACH compliant

Applications

- Surveillance Systems / CCTV
- Iris and Face Recognition
- License Plate Scanning
- Automotive Sensing
- Machine Vision
- Night Vision
- Replacement of legacy 5mm IR LEDs for improved designs

Technology Overview

Luminus SST-05-IR-850nm LEDs benefit from innovations in device technology, chip packaging and thermal management. This suite of technologies give engineers and system designers the freedom to develop solutions both high in power and efficiency.

Reliability

Luminus SST-05-IR-850nm LEDs have passed a rigorous suite of environmental and mechanical stress tests, including mechanical shock, vibration, temperature cycling and humidity. They are fully qualified for use in a wide range of high performance and high efficacy applications.

REACH & RoHS Compliance

The Luminus SST-05-IR-850nm LED is compliant to the Restriction of Hazardous Substances Directive or RoHS. The restricted materials including lead, mercury cadmium hexavalent chromium, polybrominated biphenyls (PBB) and polybrominated diphenyl ether (PBDE) are not used.

Understanding Luminus SST-05-IR-850nm LED Test Specifications

Every Luminus LED is fully tested to ensure it meets the high quality standards customers have come to expect from Luminus products.

Testing Temperature

Luminus SST-05-IR-850nm LEDs are tested and binned at 25°C junction temperature. Temperature curves are provided to allow users to scale the data for actual operating temperature conditions.

Product Ordering and Shipping Part Number Nomenclature

All SST-05-IR-850nm products are packaged and labeled with part numbers as outlined in below. When shipped, each reel will contain only a single flux wavelength and Vf bin. The part number designation is as follows:

Products	Ordering Part Number	Description
SST-05-IR-B40	SST-05-IR-B40-F###	SST-05 surface mount infrared LED

SST — 05 — CC — B40 — F###

Product Family	Chip Area	Color	Package Configuration	Bin Kit ^{1,2}
SST - Ceramic Surface Mount package w/ encapsulation	05: 0.5 mm ²	IR = Infrared	B40 - 40 deg Beam Angle B70 - 70 deg Beam Angle Ceramic 3.45mm x 3.45mm See Pages 6-7 for Detailed Drawings	See below for flux and wavelength binning information

Peak Wavelength	Minimum Flux Bin (mW)	Lens Angle	Ordering Part Number
850	235	40	<i>SST-05-IR-B40-J850</i>
	235	70	<i>SST-05-IR-B70-J850</i>

Flux Bins¹

Bin Code	Radiometric Power at 350mA, $t_p=20ms$		Correlated radiant intensity at 1.0A, $t_p=20ms$ - B40	
	Minimum Flux (mW)	Maximum Flux (mW)	Min. Radiant Intensity (mW/sr)	Max. Radiant Intensity (mW/sr)
J	235	265	697	786
K	265	295	786	875
L	295	325	875	964
M	325	355	964	1053

Wavelength Bins¹

Bin Code	Minimum Peak Wavelength (nm)	Maximum Peak Wavelength (nm)
850	840	870

Optical and Electrical Characteristics

Optical and Electrical Characteristics¹

Parameter	Symbol	Package Type		Unit
		B40	B70	
Forward Current	I_f	350		mA
Output Power Typical	PO	295		mW
Output Power at 1.0A, $t_r=20ms$ (typ.)	$PO_{1.0A}$	800		mW
Radiant Intensity at 1.0A, $t_r=20ms$ (typ.)	ϕ_e	875	500	mW/sr
Minimum Forward Voltage ¹	V_{fmin}	1.2		V
Forward Voltage Typical	V_f	1.6		V
Maximum Forward Voltage ¹	V_{fmax}	2.0		V
Viewing Angle	$2\theta_{1/2}$	40	70	deg
Peak Wavelength Typical	λ_p	850		nm
Centroid Wavelength Typical	λ_c	860		nm
FWHM Typical	$\Delta\lambda_{1/2}$	30		nm
Temperature Coefficient of Forward voltage	TC_{V_f}	-1.5		mV/°C
Temperature Coefficient of Radiometric Power	TC_{PO}	-0.3		%/°C
Temperature Coefficient of Wavelength	TC_{λ}	0.3		nm/°C
Thermal Resistance (Electrical)	R_{TH}	9.2		°C/W

Note 1: Binning based on operation at a current of 350mA, 20ms single pulse and a constant junction temperature of $T_j = 25^\circ\text{C}$. Parts are binned and shipped in 0.2V Vf increments.

Optical and Electrical Characteristics

Absolute Maximum Ratings²

Parameter	Symbol	Rating	Unit
Forward Current ^{3,4}	I	1.0	A
Power Dissipation	P _D	2.5	W
Reverse Voltage	V _R	5	V
Storage Temperature	T _{STG}	-40~100	°C
Junction Temperature ^{3,4}	T _J	115 °C	°C
Soldering Temperature	T _{SLD}	JEDEC 020 , 260 °C	
ESD Sensitivity (HBM)	V _B	6000	V

Note 2: To prevent damage refer to operating conditions and derating curves for appropriate maximum operating conditions

Note 3: Luminus SST-05-IR-850nm LEDs are designed for operation up to an absolute maximum forward drive current as specified above. Product lifetime data is specified at typical forward drive currents. Sustained operation at absolute maximum currents will result in a reduction of device lifetime compared to typical forward drive currents. Actual device lifetimes will also depend on junction temperature.

Note 4: Maximum operating case temperature combined with maximum drive current defines the total maximum operating condition for the device. To prevent damage, please operate devices within specified conditions.

Note 5: Caution must be taken not to stare at the light emitted from these LEDs. Under special circumstances, the high intensity could damage the eye.

Optical and Electrical Characteristics

Relative Output Flux vs. Forward Current

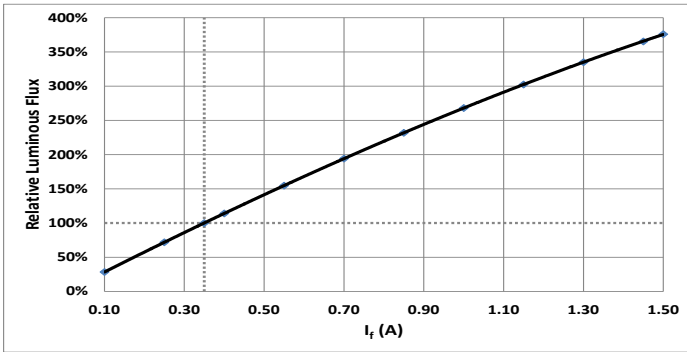

Relative Voltage vs Forward Current

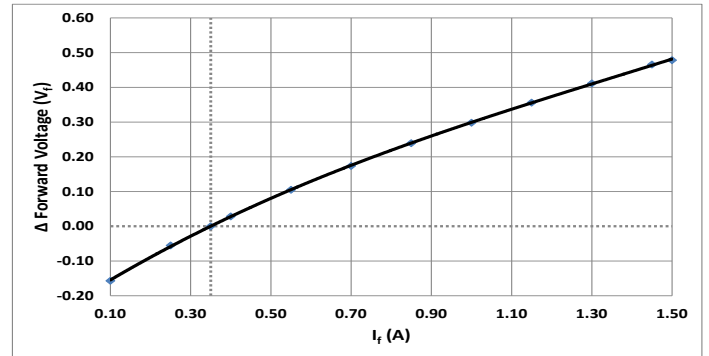

Relative Output Flux vs. Temperature

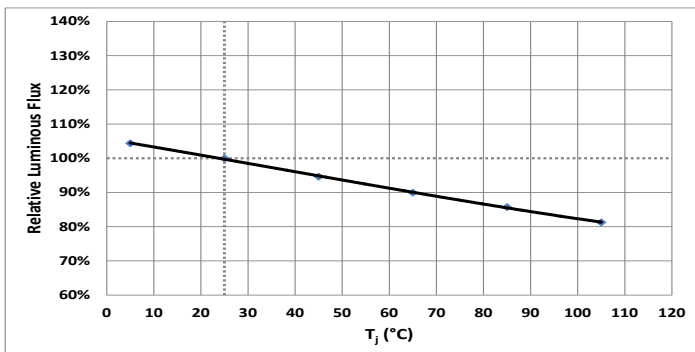

Typical Spectra

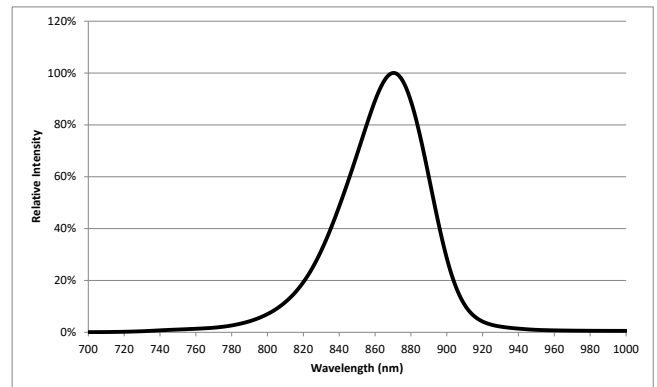

Typical Polar Radiation Plot - B40

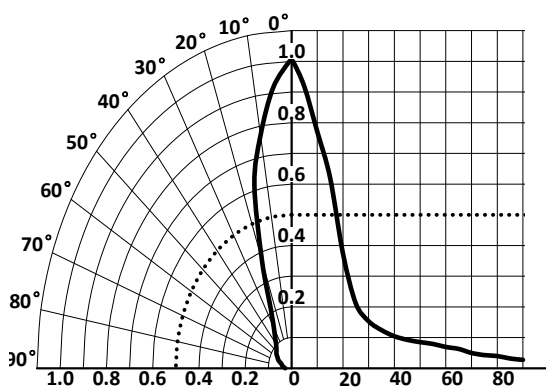

Typical Polar Radiation Plot - B40

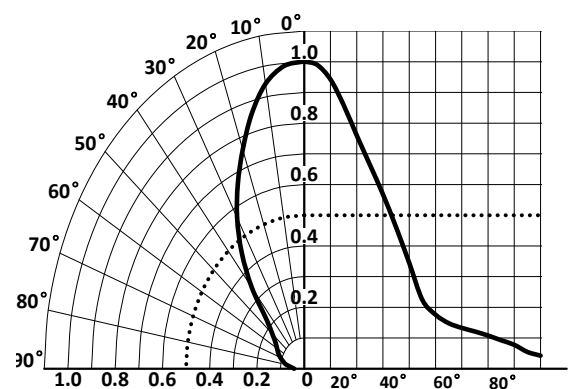

Mechanical Dimensions - B40 Package

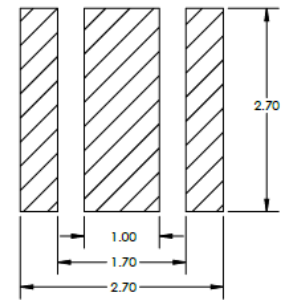
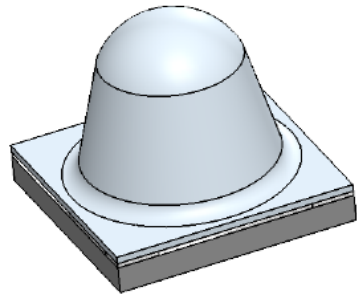
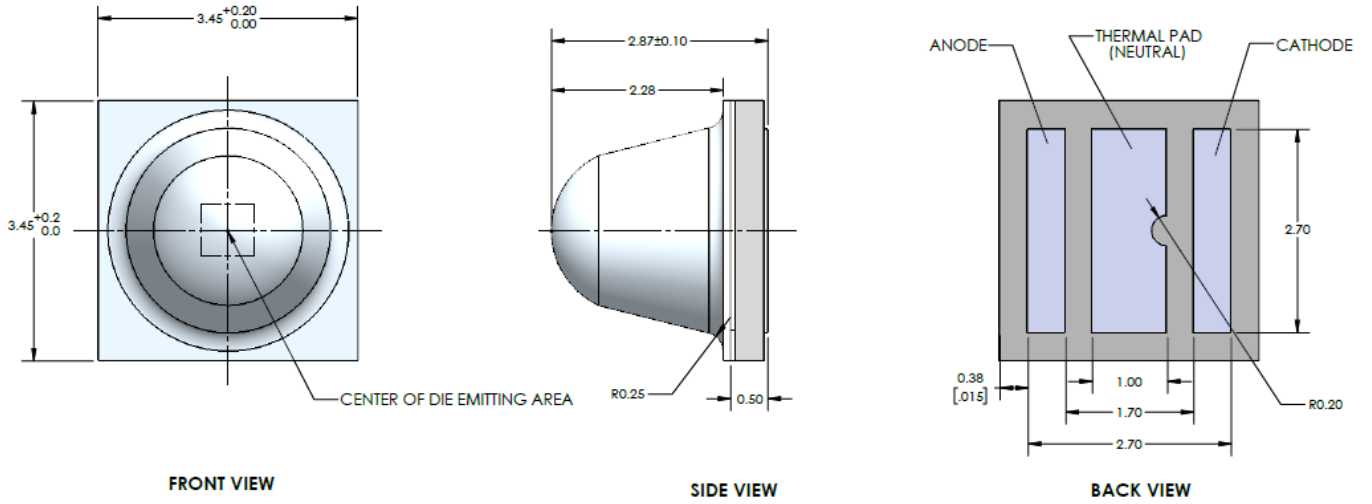

Tape and Reel - B40 Package

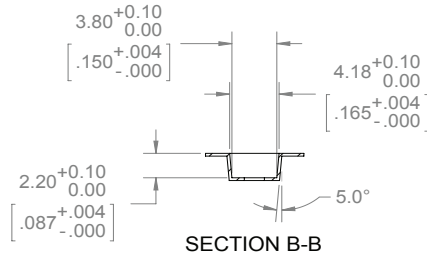
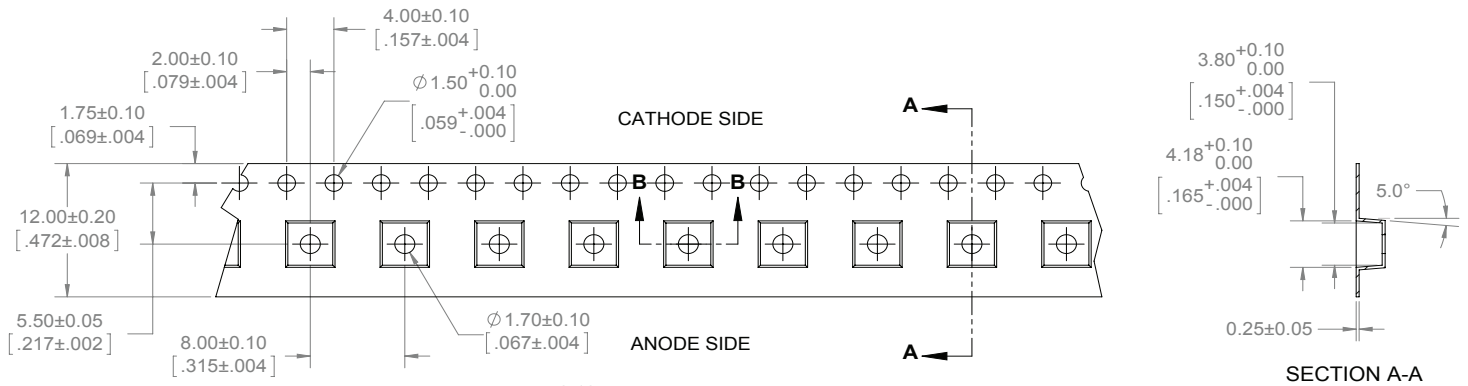

NOTES:

1. FINAL TAPE AND REEL PACKAGING MUST MEET THE REQUIREMENTS OF JEDEC-STD-033, LEVEL 2A.
2. LEAVE 304.8mm [12.00 in] OF TAPE EMPTY FOR LEAD IN (38 EMPTY POCKETS).
3. LEAVE 457.2mm [18.00 in] OF TAPE EMPTY FOR TRAILER (57 EMPTY POCKETS).
4. MUST COMPLY TO EIA-481-C-2003

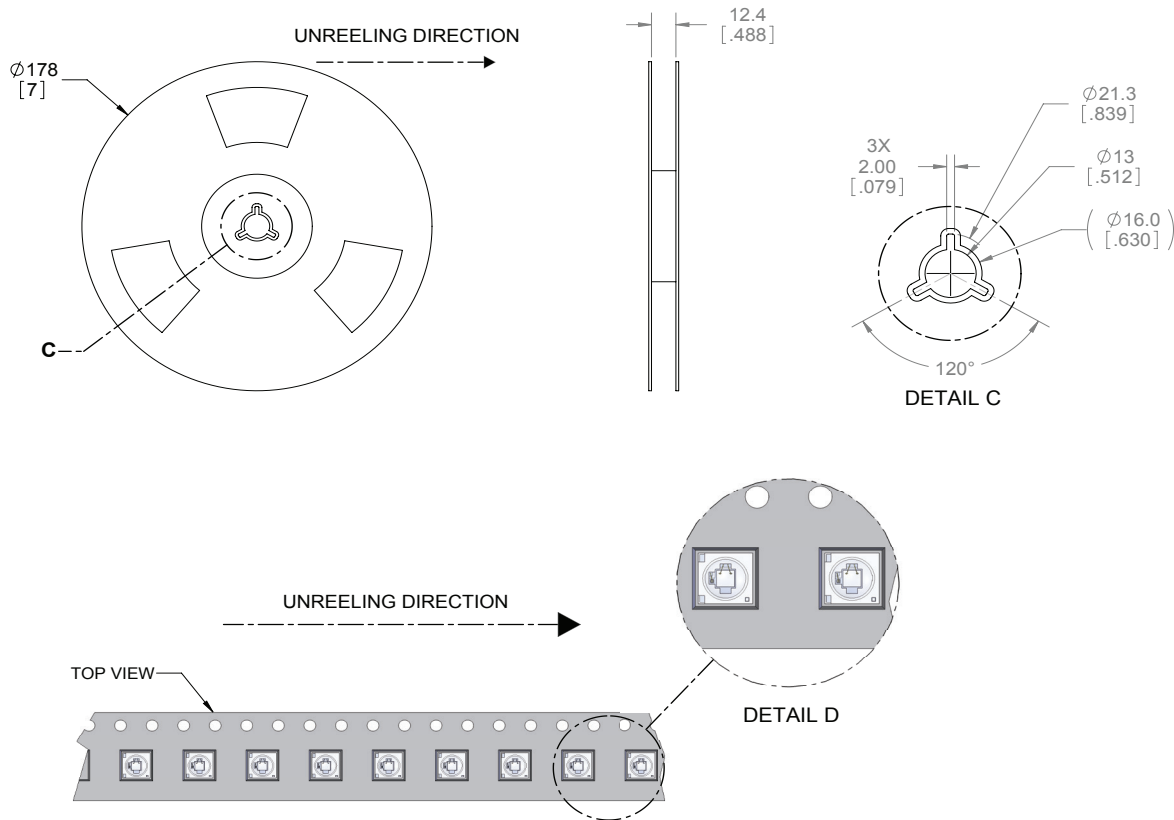

Reel Packaging (500 parts per reel)

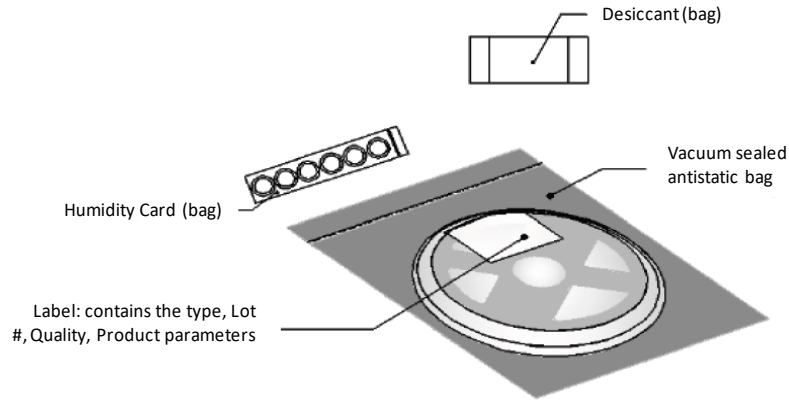

Reel Label

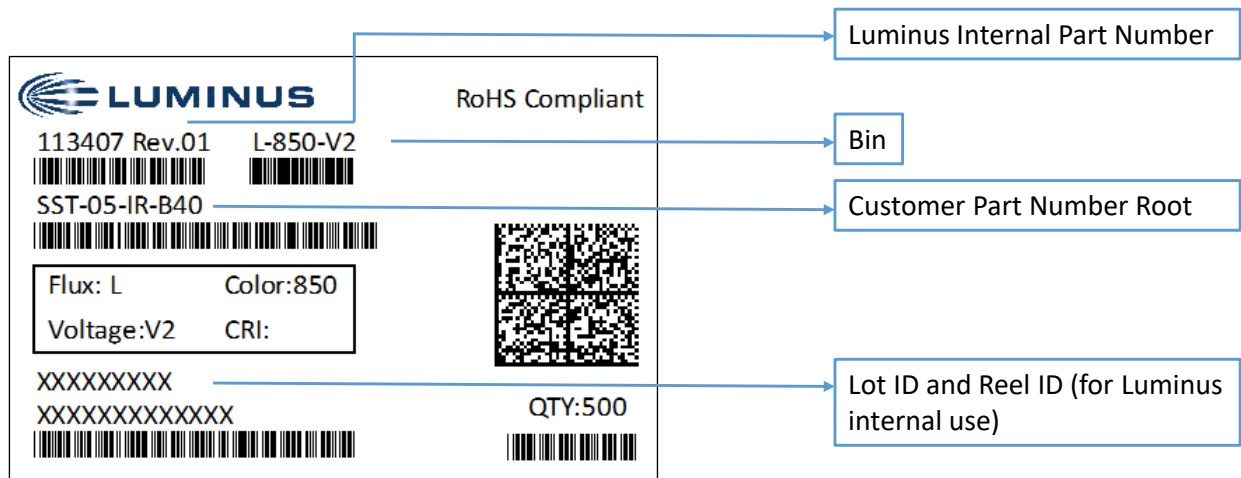

Shipping Label

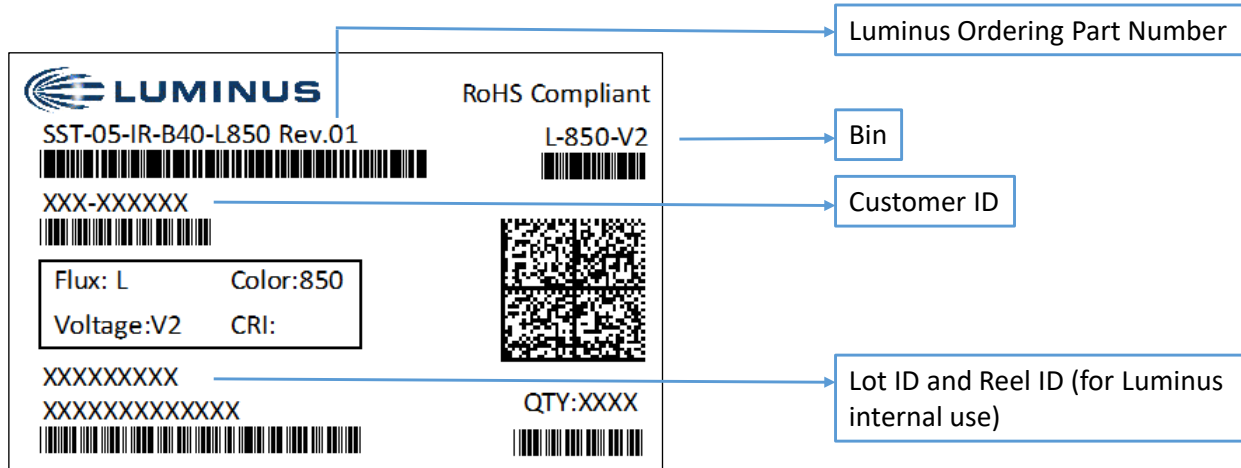

Box Packaging Information

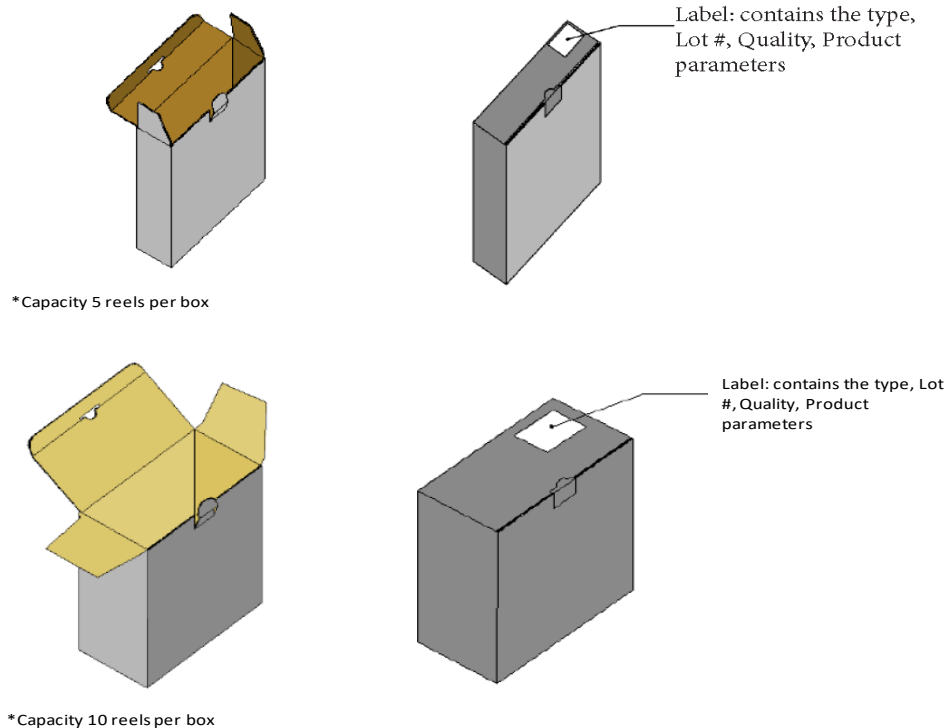

Soldering Profile

Profile Feature	Sn-Pb Eutectic Assembly	Pb-Free Assembly
Preheat & Soak	100 °C	150 °C
Temperature min (T _{smin})	150 °C	200 °C
Temperature max (T _{smax})	60-120 seconds	60-120 seconds
Time (T _{smin} to T _{smax}) (t _s)		
Average ramp-up rate (T _{smax} to T _p)	3 °C/second max	3 °C/second max
Liquidous temperature (T _L)	183 °C	217 °C
Time at liquidous (t _L)	60-150 seconds	60-150 seconds
Peak package body temperature (T _p)*	230 °C ~235 °C	255 °C ~260 °C
Classification temperature (T _c)	235 °C	260 °C
Time (t _p) within 5 °C of the specified classification temperature (T _c)	20 seconds	30 seconds
Average ramp-down rate (T _p to T _{smax})	6 °C/second max	6 °C/second max
Time 25 °C to peak temperature	6 minutes max	8 minutes max

* Tolerance for peak profile temperature(T_p) is defined as a supplier minimum and a user maximum.

** Tolerance for time at peak profile temperature(t_p) is defined as a supplier minimum and a user maximum.

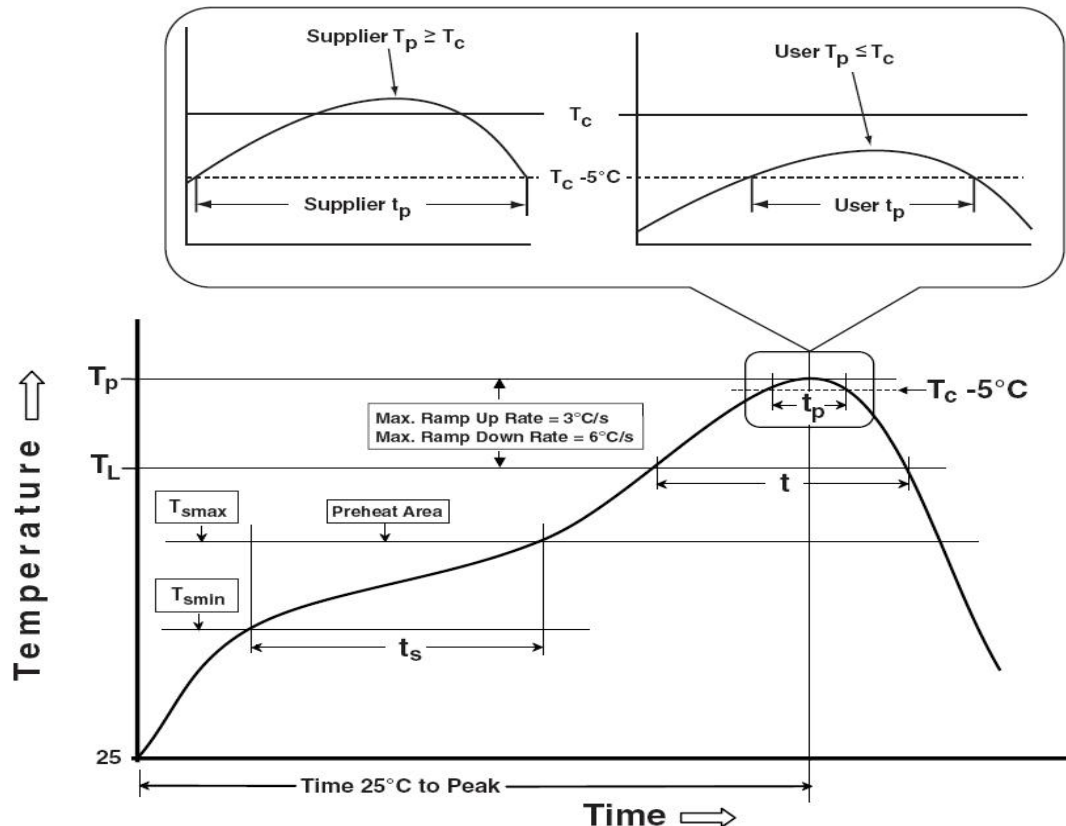

Precautions for Use

Storage:

1. Before opening the package

The LEDs should be kept at <40 & $<90\%RH$. The LEDs should be used within a year. When storing the LEDs, moisture proof package with absorbent material (silica gel) is recommended.

2. After opening the package

The LEDs should be kept at ≤ 30 & $\leq 60\%RH$. The LEDs should be soldered within 168 hours (7days) after opening the moisture proof package.

If unused LEDs remain, they should be stored in moisture proof packages, such as sealed containers with moisture proof package within absorbent material (silica gel). It is also recommended to return the unused LEDs to the original moisture proof package and to seal the moisture proof package again.

If the moisture absorbent material (silica gel) vapors or expires the expiration date, baking treatment should be performed by using the following conditions : 60 °C for 20 hours.

The LEDs electrode and leadframe comprise a silver plated copper alloy. The silver surface may be affected by environments. Please avoid conditions which may cause the LEDs being corroded or discolored. The corrosion or discoloration might lower solderability or affect optical characteristics.

Please avoid rapid transition in ambient temperature, especially in high humidity environments where condensation can occur.

Static Electricity:

1. The products are sensitive to static electricity, and care should be taken when handling them.

2. Static electricity or surge voltage will damage the LEDs. It is recommended to wear a anti-electrostatic wristband or an anti-electrostatic gloves when handling the LEDs.

3. All devices, equipment and machinery must be properly grounded. It is recommended that measures be taken against surge voltage to the equipment that mounts the LEDs.

History of Changes

Rev	Date	Description of Change
01	10/15/2018	Initial Release
02	01/01/2019	Added B70 package type

The products, their specifications and other information appearing in this document are subject to change by Luminus Devices without notice. Luminus Devices assumes no liability for errors that may appear in this document, and no liability otherwise arising from the application or use of the product or information contained herein. None of the information provided herein should be considered to be a representation of the fitness or suitability of the product for any particular application or as any other form of warranty. Luminus Devices' product warranties are limited to only such warranties as accompany a purchase contract or purchase order for such products. Nothing herein is to be construed as constituting an additional warranty. No information contained in this publication may be considered as a waiver by Luminus Devices of any intellectual property rights that Luminus Devices may have in such information. Big Chip LEDs™ is a registered trademark of Luminus Devices, Inc., all rights reserved.

This product is protected by U.S. Patents 6,831,302; 7,074,631; 7,083,993; 7,084,434; 7,098,589; 7,105,861; 7,138,666; 7,166,870; 7,166,871; 7,170,100; 7,196,354; 7,211,831; 7,262,550; 7,274,043; 7,301,271; 7,341,880; 7,344,903; 7,345,416; 7,348,603; 7,388,233; 7,391,059 Patents Pending in the U.S. and other countries.