

REACH & RoHS  
COMPLIANT

REV.	ECN / DESCRIPTION	BY	DATE
A0	NEW	ZG.HU	2017.12.26

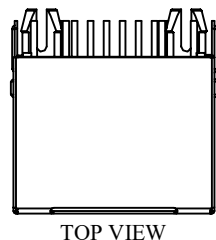

**MATERIAL:**  
 HOUSING: LCP,UL94V-0,BLACK.  
 TERMINAL: PHOSPHOR BRONZE Ø=0.46MM,  
 G/FU" GOLD PLATING ON CONTACT AREA.  
 SHIELD: C2680,T=0.20MM,20 MIN NICKEL PLATING  
 ON ALL AREA.

**MECHANICAL:**  
 DURABILITY: 750 CYCLES MIN,12.5MM/MINUTE.  
 INSERTION FORCE: 2.2KG.F MAX.  
 RETENTION STRENGTH : 7.7KG.F BETWEEN JACK AND PLUG.  
 OPERATING TEMPERATURE: -40°C~+85°C.  
 STORAGE TEMPERATURE: -40°C~+85°C.  
 ALL CRITICAL DIMENSIONS WITH "\*"

**ELECTRICAL:**  
 VOLTAGE: 125 VOLTS AC.  
 CURRENT RATING : 1.5AMP.  
 DIELECTRIC STRENGTH: 1000 VAC RMS 50HZ OR 60HZ,1MIN.  
 INSULATION RESISTANCE: 500 MEGA OHMS MIN. INITIAL  
 AFTER 500V DC FOR 1 MINUTE.  
 CONTACT RESISTANCE: SINGLE TERMINAL 30 MILLIOHMS MAX.  
 INITIAL 50 MILLIOHMS MAX. AFTER  
 DURABILITY TEST.

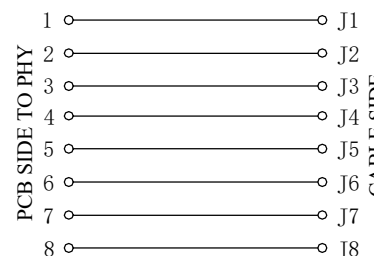
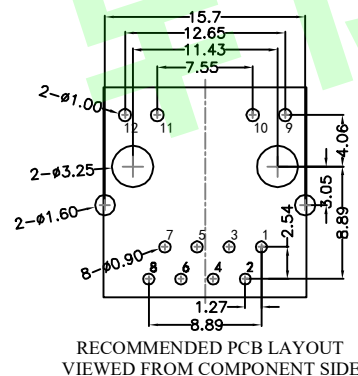
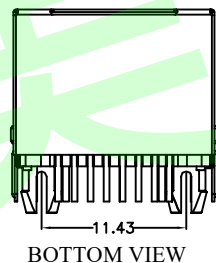
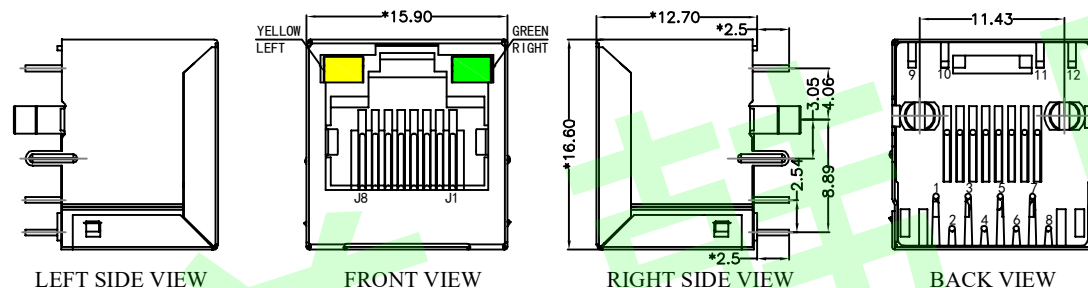

LED Specification

Standard LED Color	LED Wavelength	Foward(A)	Foward(V)
Green	568nm	20mA	1.85-2.45V
Yellow	585nm	20mA	1.7-2.2V

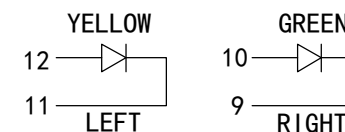

TITLE: 180° TAB-UP	SIZE A4	UNITS MM[INCH]	GENERAL TOLERANCES UNLESS SPECIFIED		APPROVED BY: JP.Gong
PART NO.: DGUK52A1188AB1A6DY1143	SACLE 1:1	REV A0	x±0.35	x°±3.0°	CHECKED BY: TW.Xu
REMARK:	SHEET 1/2		.xx±0.25	.xx°±1.5°	DESIGND BY: ZG.Hu
			.xxx±0.10	.xxx°±1.0°	

东莞市美韩电子科技有限公司  
 Dongguan Usakro Electronic Technology Co., Ltd.  
 Tel : 0769-87869902      http://www.usakro.com

REACH & RoHS  
COMPLIANT

REV.	ECN / DESCRIPTION	BY	DATE
A0	NEW	ZG.HU	2017.12.26

Suggested Panel Opening:

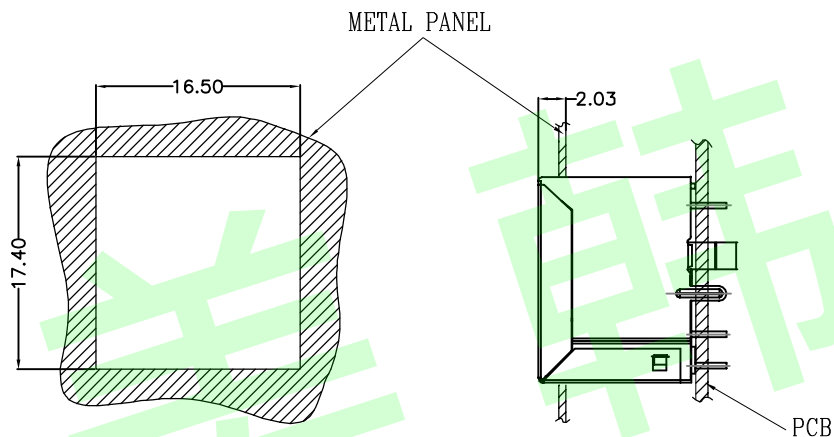

UNIT: mm / inch  
Tolerances:  $\pm 0.10$  / 0.004

Keep-Out Area (Component Side View):

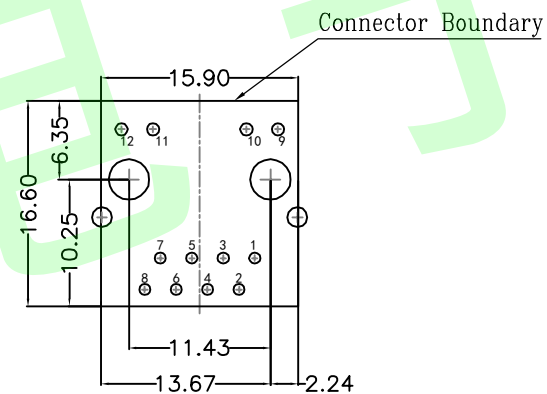

UNIT: mm / inch  
Tolerances:  $\pm 0.10$  / 0.004



东莞市美韩电子科技有限公司

Dongguan Usakro Electronic Technology Co., Ltd.

Tel : 0769-87869902

<http://www.usakro.com>

TITLE:  
180° TAB-UP

PART NO.:  
DGUK52A1188AB1A6DY1143

REMARK:

SIZE  
A4

SACLE  
1:1

SHEET  
2/2

UNITS  
MM[INCH]

REV  
A0

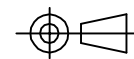

GENERAL TOLERANCES  
UNLESS SPECIFIED

$x \pm 0.35$   
 $.x \pm 0.30$   
 $.xx \pm 0.25$   
 $.xxx \pm 0.10$

$x^\circ \pm 3.0^\circ$   
 $.x^\circ \pm 2.0^\circ$   
 $.xx^\circ \pm 1.5^\circ$   
 $.xxx^\circ \pm 1.0^\circ$

APPROVED BY:  
JP.Gong

CHECKED BY:  
TW.Xu

DESIGN BY:  
ZG.Hu