

N-Channel 30-V(D-S) MOSFET

V(BR)DSS	RDS(on)MAX	ID
30 V	25mΩ@10V	5.8A
	37mΩ@4.5V	

FEATURE:

※ TrenchFET Power MOSFET

DESCRIPTION :

The AO3404 use advanced trench technology to provide excellent RDS(ON) and low gate charge. This device is suitable for use as a load switch or in PWM applications. The source leads are separated to allow a Kelvin connection to the source, which may be used to bypass the source inductance.

MARKING:

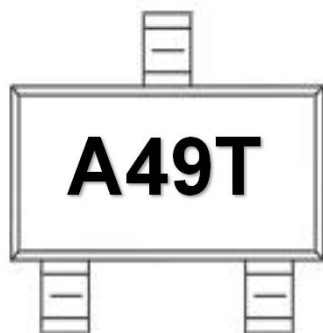

Equivalent Circuit:

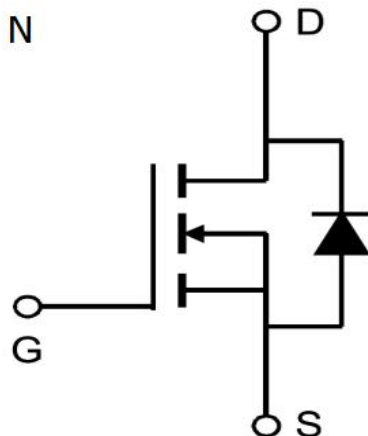

SOT- 23

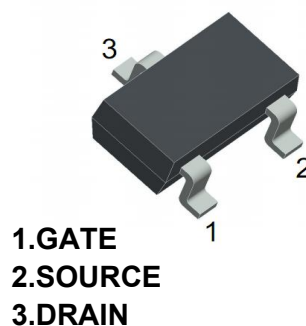

Mosfet Maximum ratings (Ta=25°C unless otherwise noted)

Parameter	Symbol	Value	Unit
Drain-Source Voltage	VDS	30	V
Gate-Source Voltage	VGS	±20	
Continuous Drain Current	ID	5.8	A
Pulsed drain current *	IDM	30	
Power Dissipation	PD	1.4	W
Thermal Resistance from Junction to Ambient	RθJA	357	°C/W
Junction Temperature	TJ	150	°C
Storage Temperature	TSTG	-55~+150	°C

* Repetitive rating : Pulse width limited by maximum junction temperature.

MOSFET ELECTRICAL CHARACTERISTICS

Static Electrical Characteristics (Ta = 25 °C Unless Otherwise Noted)

Parameter	Symbol	Test Condition	Min	Typ	Max	Unit
Static Parameters						
Drain-source breakdown voltage	V(BR)DSS	VGS = 0V, ID = 250μA	30			V
Gate-threshold voltage	VGS(th)	VDS = VGS, ID = 250μA	1		2.5	V
Gate-body leakage	IGSS	VDS = 0V, VGS = ±20V			±100	nA
Zero gate voltage drain current	IDSS	VDS = 30V, VGS = 0V			1	μA
Drain-source on-resistancea	RDS(on)	VGS = 10V, ID = 5.8A		18	25	mΩ
		VGS = 4.5V, ID = 4.8A		27	37	mΩ
Forward transconductancea	gfs	VDS = 4.5V, ID = 5.8A		22		S
Diode forward voltage	VSD	IS = 1A, VGS = 0V		0.8	1.28	V
Dynamic Parameters						
Input capacitance	Ciss	VDS = 15V, VGS = 0V, f = 1MHz		373	448	pF
Output capacitance	Coss			67		pF
Reverse transfer capacitanceb	Crss			41		pF
Gate resistance	Rg	VDS = 0V, VGS = 0V, f = 1MHz		1.8	2.8	Ω
Switching Parameters						
Turn-on delay time	td(on)	VGS = 10V, VDS = 15V RL = 2.6Ω, RGEN = 3Ω		4.5	6.5	ns
Rise time	tr			2.4		ns
Turn-off delay time	td(off)			14.8		ns
Fall time	tf			2.5		ns
Total gate charge	Qg	VDS = 15V, VGS = 10V, ID = 5.8A		7.1	11	nC
Gate-source charge	Qgs			1.4		nC
Gate-drain charge	Qgd			1.7		nC
Body Diode Reverse Recovery Time	Trr	IF = 5.8A, dI/dt = 100A/μs		10.5		ns
Body Diode Reverse Recovery Charge	Qrr	IF = 5.8A, dI/dt = 100A/μs		4.5		nC

Note :

1. These parameters have no way to verify.
2. Pulse Test ; Pulse Width ≤ 300μs, Duty Cycle ≤ 0.5%.

TYPICAL ELECTRICAL AND THERMAL CHARACTERISTICS

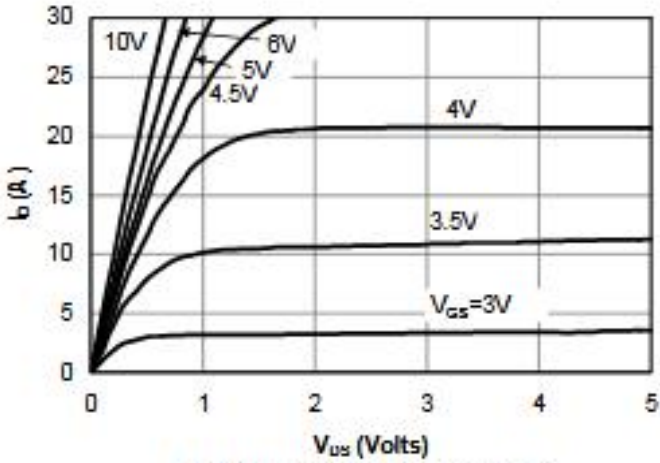

Fig 1: On-Region Characteristics

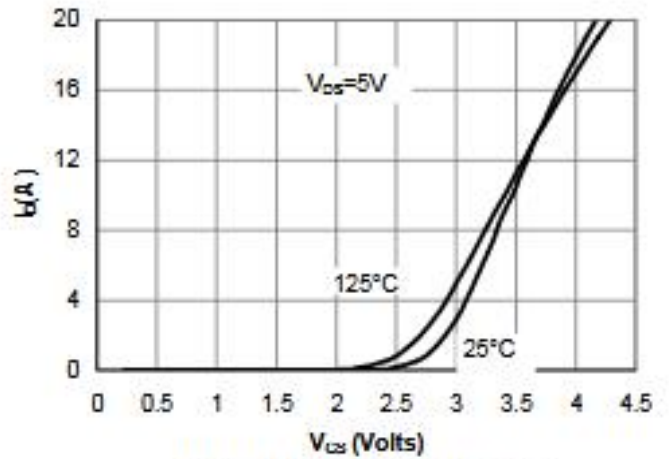

Figure 2: Transfer Characteristics

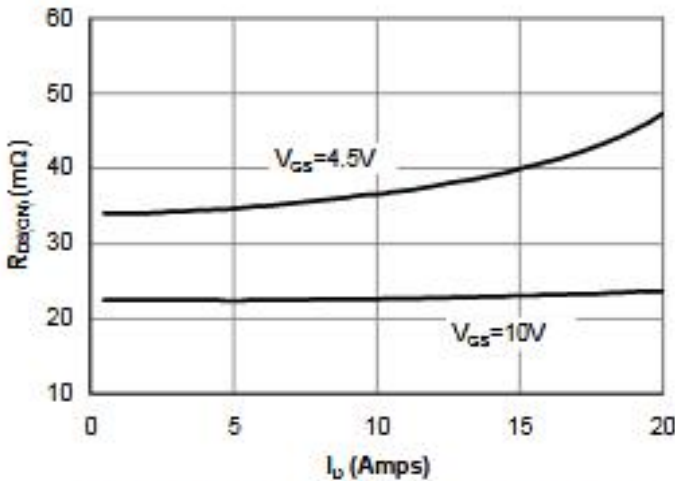

Figure 3: On-Resistance vs. Drain Current and Gate Voltage

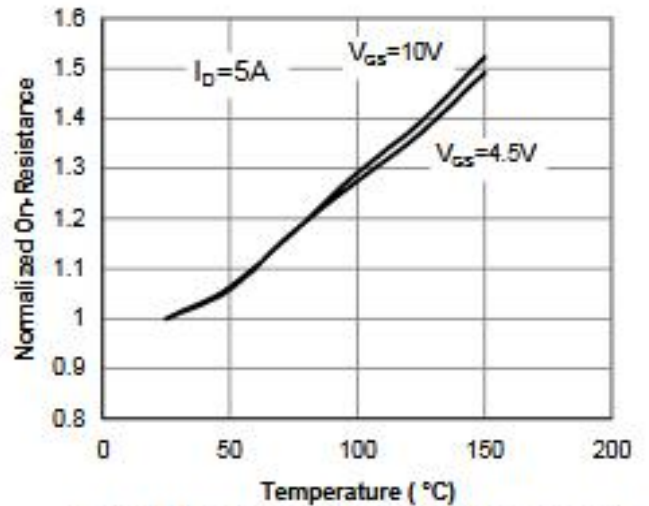

Figure 4: On-Resistance vs. Junction Temperature

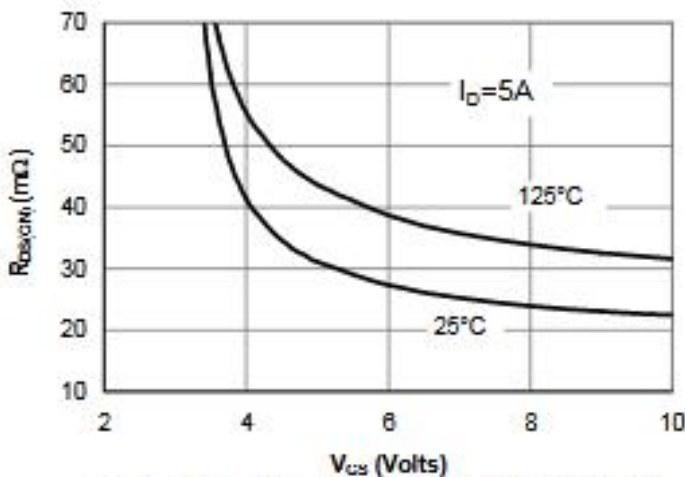

Figure 5: On-Resistance vs. Gate-Source Voltage

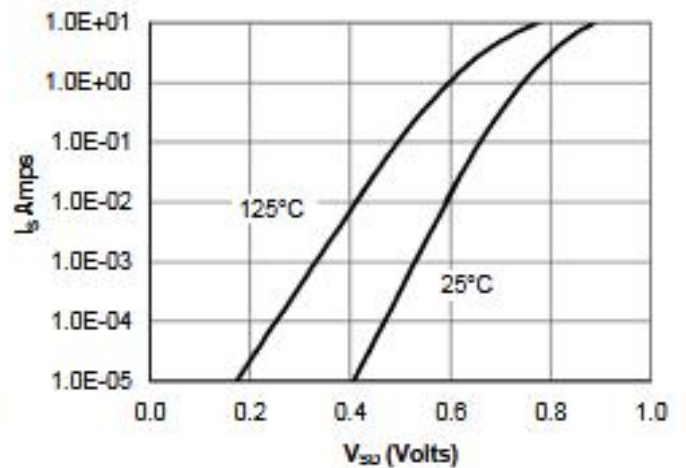

Figure 6: Body diode characteristics

TYPICAL ELECTRICAL AND THERMAL CHARACTERISTICS

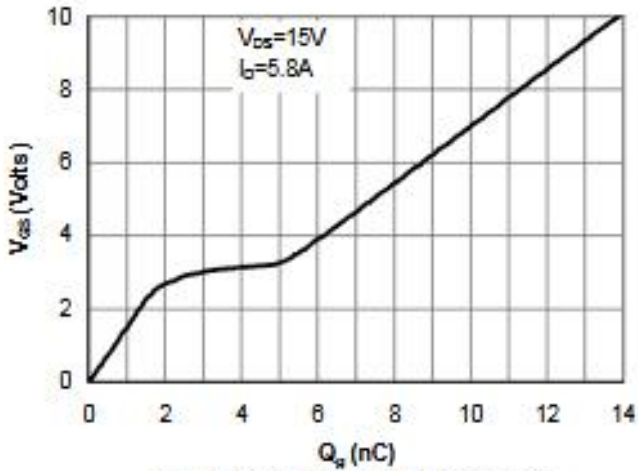

Figure 7: Gate-Charge characteristics

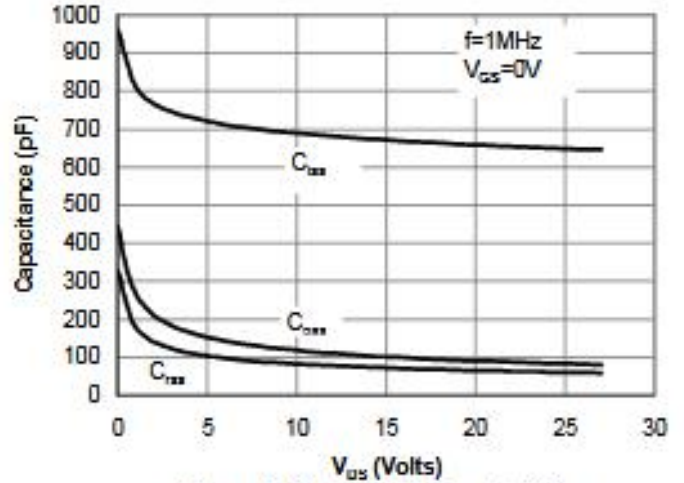

Figure 8: Capacitance Characteristics

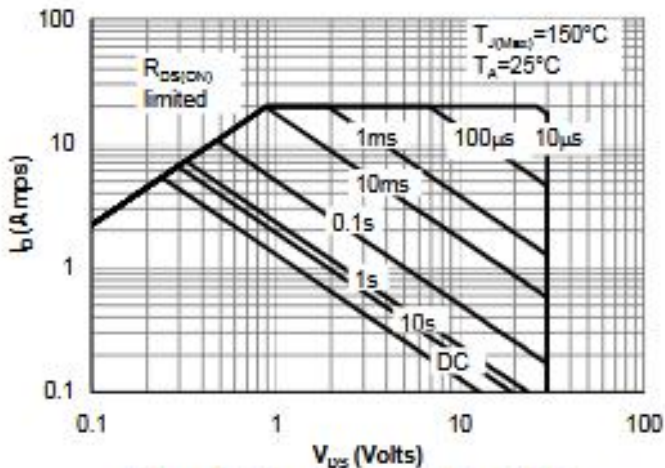

Figure 9: Maximum Forward Biased Safe Operating Area (Note E)

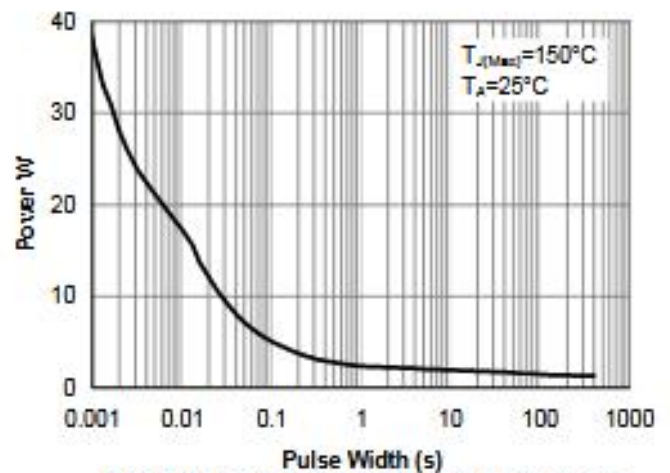

Figure 10: Single Pulse Power Rating Junction-to-Ambient (Note E)

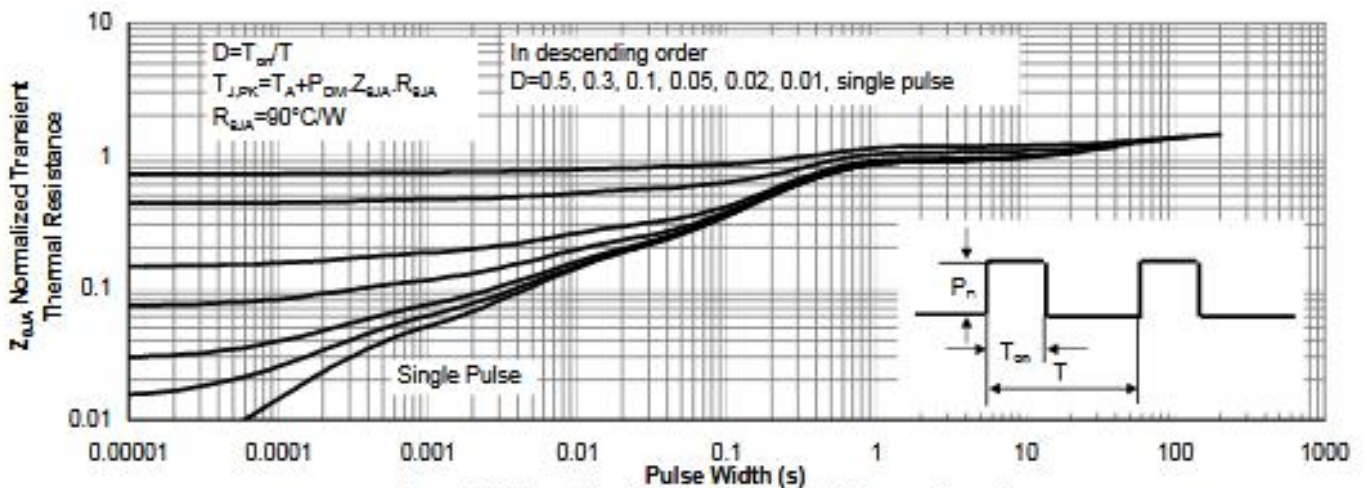
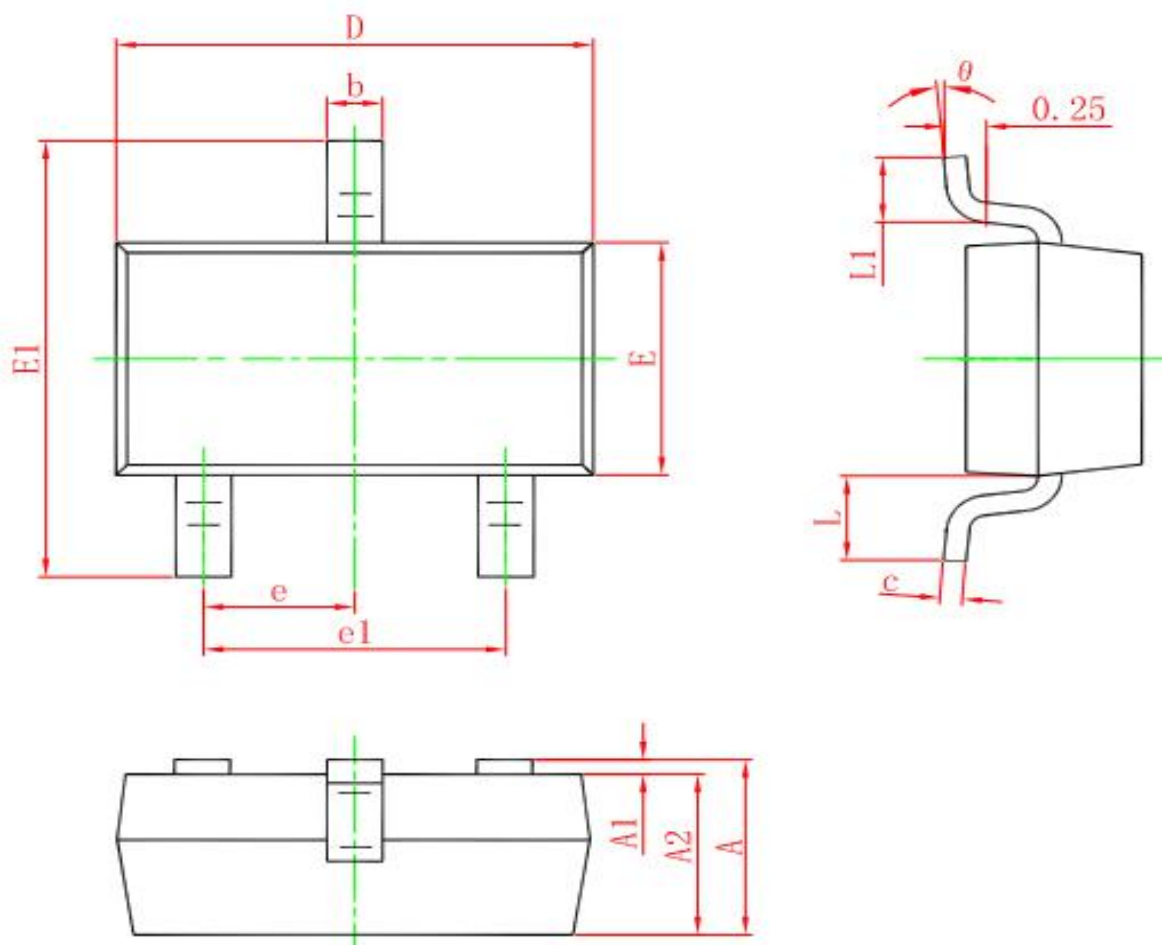

Figure 11: Normalized Maximum Transient Thermal Impedance

SOT-23 PACKAGE OUTLINE DIMENSIONS



Symbol	Dimensions In Millimeters		Dimensions In Inches	
	Min.	Max.	Min.	Max.
A	0.900	1.150	0.035	0.045
A1	0.000	0.100	0.000	0.004
A2	0.900	1.050	0.035	0.041
b	0.300	0.500	0.012	0.020
c	0.080	0.150	0.003	0.006
D	2.800	3.000	0.110	0.118
E	1.200	1.400	0.047	0.055
E1	2.250	2.550	0.089	0.100
e	0.950 TYP.		0.037 TYP.	
e1	1.800	2.000	0.071	0.079
L	0.550 REF.		0.022 REF.	
L1	0.300	0.500	0.012	0.020
θ	0°	8°	0°	8°