

SuperMOS – PDFN3*3-8L -30V BV_{DSS}, 8mΩ R_{DS(on)}, P-channel MOSFET

1. Description

The AP30P30Q-ES is P-Channel enhancement MOS Field Effect Transistor. Uses advanced trench technology and design to provide excellent R_{DS(ON)} with low gate charge. Device is suitable for use in DC-DC conversion, power switch and charging circuit. Standard Product AP30P30Q-ES is Pb-free.

2. Features

- -30V, R_{DS(ON)}=8.0mΩ(TYP.) @V_{GS}=-10V
- R_{DS(ON)}=11.5mΩ(TYP.) @V_{GS}=-4.5V
- Fast Switching
- High density cell design for low R_{DS(on)}
- Material: Halogen free
- Reliable and rugged
- Avalanche Rated
- Low leakage current

3. Applications

- PWM applications
- Load switch
- Power management in portable/desktop PCs
- DC/DC conversion

100% UIS TESTED!

4. Ordering Information

Part Number	Package	Marking	Material	Packing	Quantity per reel	Flammability Rating	Reel Sizes
AP30P30Q-ES	PDFN3*3-8L	ES3347/LOT	Halogen free	Tape & Reel	5,000 PCS	UL 94V-0	13 inches

Table-1 Ordering information

5. Pin Configuration and Functions

Pin	Function	Outline	Circuit Diagram
4	Gate		
1/2/3	Source		
5/6/7/8	Drain		

Table-2 Pin configuration

6. Specification

Absolute Maximum Rating & Thermal Characteristics

Ratings at 25 °C ambient temperature unless otherwise specified.

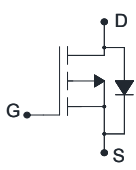
Parameter	Symbol	Limit	Unit
Drain-Source Voltage	BV_{DSS}	-30	V
Gate-Source Voltage	V_{GS}	±25	V
Continuous Drain Current	I_D	$T_C=25^{\circ}C$	-39
		$T_C=75^{\circ}C$	-30
Maximum Power Dissipation	P_D	$T_C=25^{\circ}C$	30
		$T_C=75^{\circ}C$	17.8
Pulsed Drain Current ^a	I_{DM}	-156	A
Avalanche Current, Single Pulsed ^b	I_{AS}	-25	A
Avalanche Energy, Single Pulsed ^b	E_{AS}	93.7	mJ
Operating Junction Temperature	T_J	150	°C
Storage Temperature Range	T_{stg}	-55 to +150	°C

Thermal resistance ratings

Parameter	Symbol	Typical	Unit
Junction-to-Ambient Thermal Resistance	$t \leq 10 \text{ s}$	$R_{\theta JA}$	40
Junction-to-Case Thermal Resistance	Steady State	$R_{\theta JC}$	4.2

Note:

a: Repetitive rating, pulse width limited by junction temperature, $t_p=10\mu\text{s}$, Duty Cycle=1%

b: EAS condition: $T_J=25^{\circ}C, V_{DD}=-30V, V_G=-10V, L=0.3\text{mH}, R_g=25\Omega$

Electrical Characteristics

At TA = 25°C unless otherwise specified

Parameter	Symbol	Test Conditions	Min.	Typ.	Max.	Unit
OFF CHARACTERISTICS						
Drain-to-Source Breakdown Voltage	BV_{DSS}	$V_{GS}=0V, I_D=-250\mu A$	-30			V
Zero Gate Voltage Drain Current	I_{DSS}	$V_{DS}=-30V, V_{GS}=0V$			-1	μA
Gate-to-source Leakage Current	I_{GSS}	$V_{DS}=0V, V_{GS}=\pm 25V$			± 100	nA
ON CHARACTERISTICS						
Gate Threshold Voltage	$V_{GS(TH)}$	$V_{GS}=V_{DS}, I_D=-250\mu A$	1.0	-1.4	-2.0	V
Drain-to-source On-resistance	$R_{DS(on)}$	$V_{GS}=-10V, I_D=-12A$		8	13	m Ω
		$V_{GS}=-4.5V, I_D=-7A$		11.5	18	
Forward Trans conductance	g_{FS}	$V_{DS}=-5.0V, I_D=-6A$		24	40	S
CHARGES, CAPACITANCES AND GATE RESISTANCE						
Input Capacitance	C_{ISS}	$V_{GS}=0V, f=1MHz,$ $V_{DS}=-15V$		1780		pF
Output Capacitance	C_{OSS}			235		
Reverse Transfer Capacitance	C_{RSS}			200		
Gate Resistance	R_g	$f=1MHz$		2.5		Ω
Total Gate Charge	$Q_{G(TOT)}$	$V_{GS}=-10V, V_{DS}=-15V,$ $I_D=-20A$		46		nC
Gate-to-Source Charge	Q_{GS}			1.0		
Gate-to-Drain Charge	Q_{GD}			1.4		
SWITCHING CHARACTERISTICS						
Turn-On Delay Time	$t_{d(ON)}$	$V_{GS}=-10V, V_{DS}=-15V,$ $R_L=1\Omega, R_G=3\Omega$		8		ns
Rise Time	t_r			27		
Turn-Off Delay Time	$t_{d(OFF)}$			68		
Fall Time	t_f			39		
BODY DIODE CHARACTERISTICS						
Forward Voltage	V_{SD}	$V_{GS}=0V, I_S=-1.0A$		-0.75	-1.5	V

7. Typical Characteristic

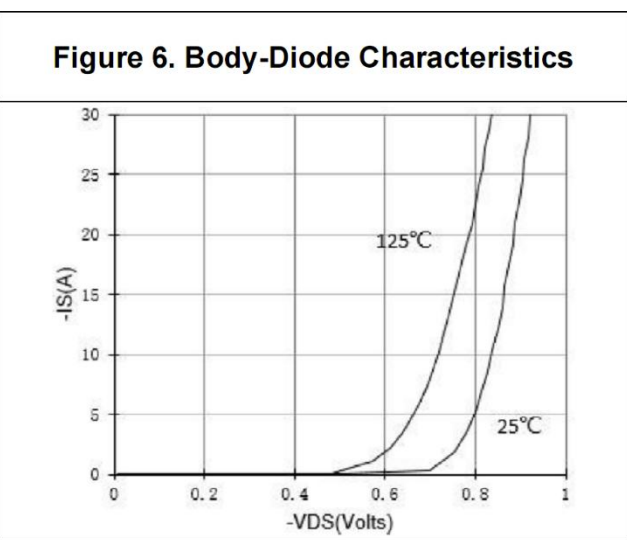
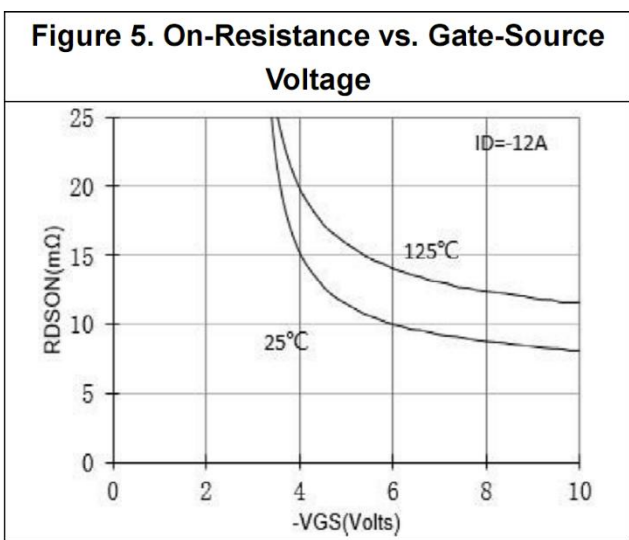
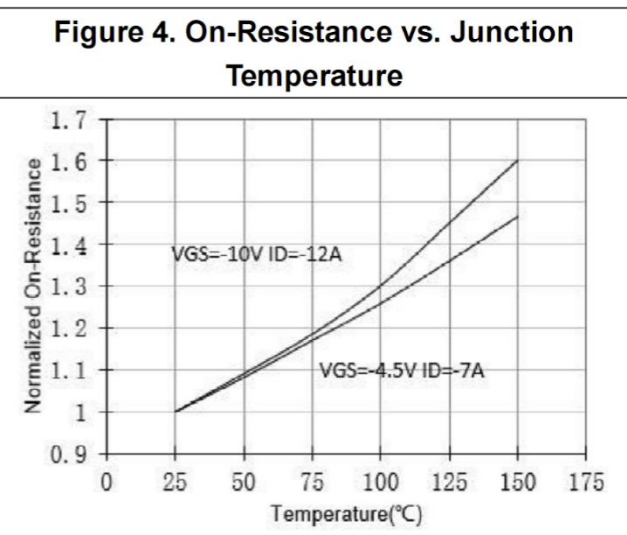
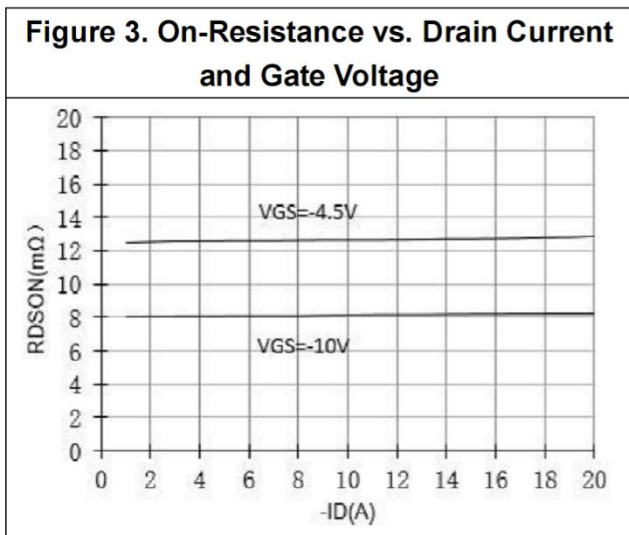
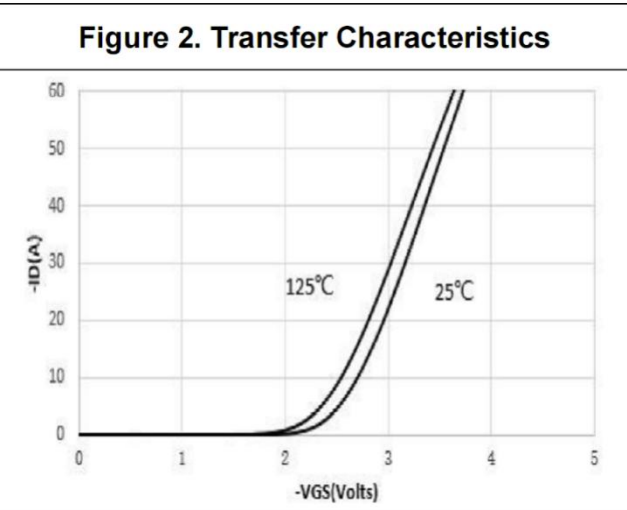
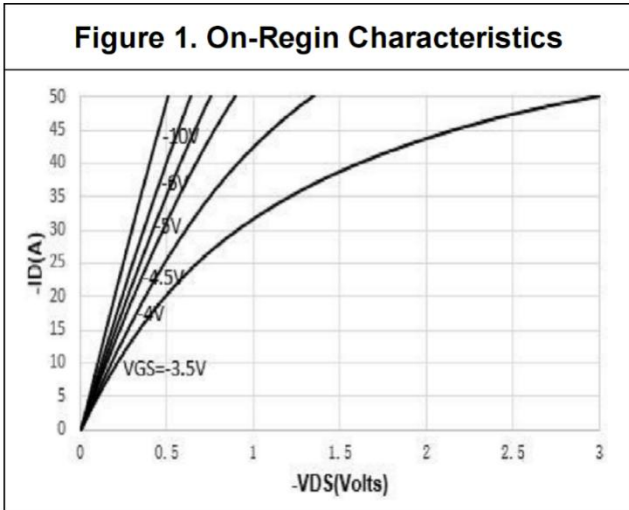

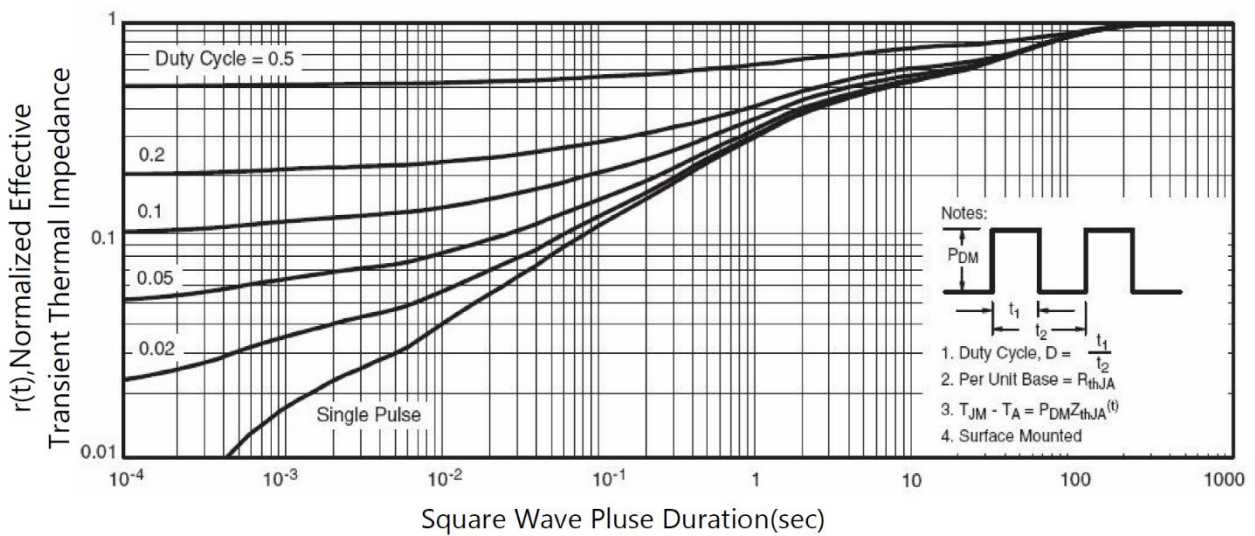
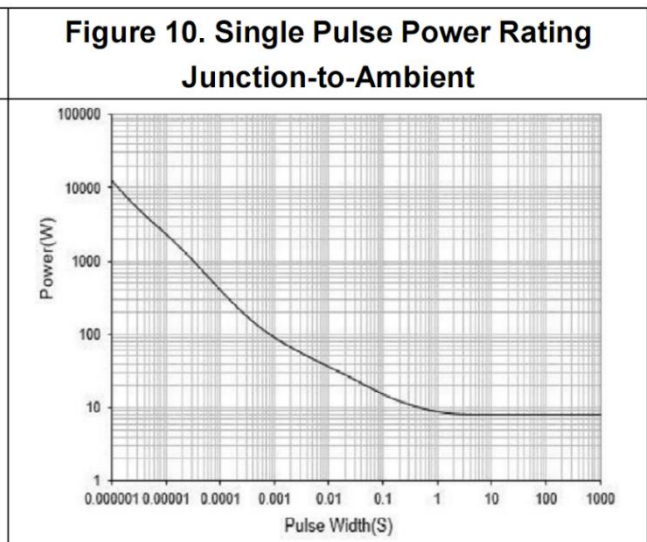
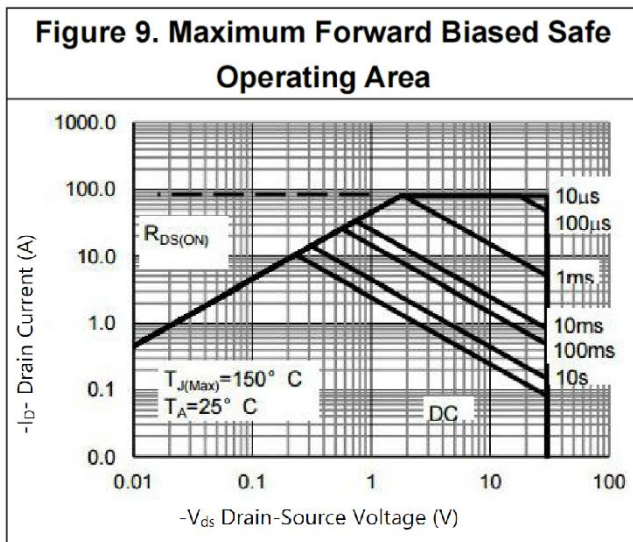
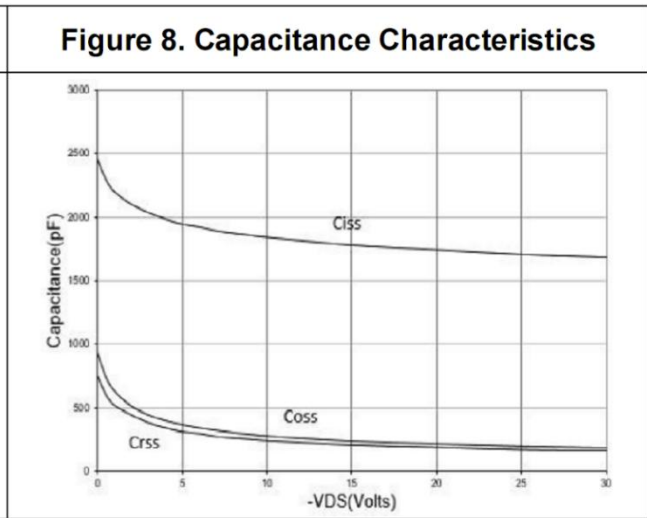
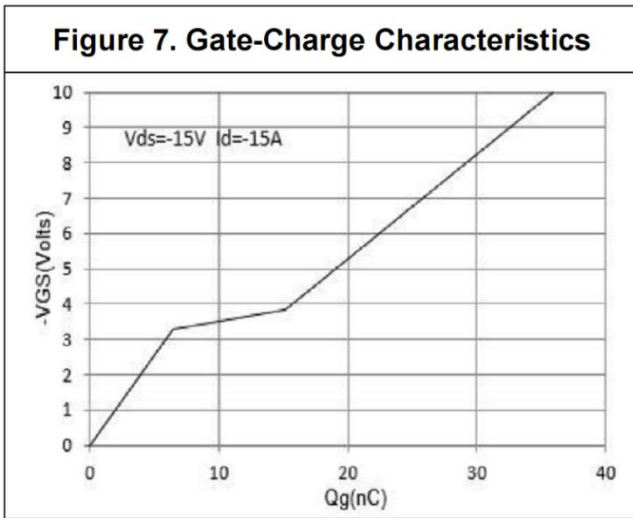
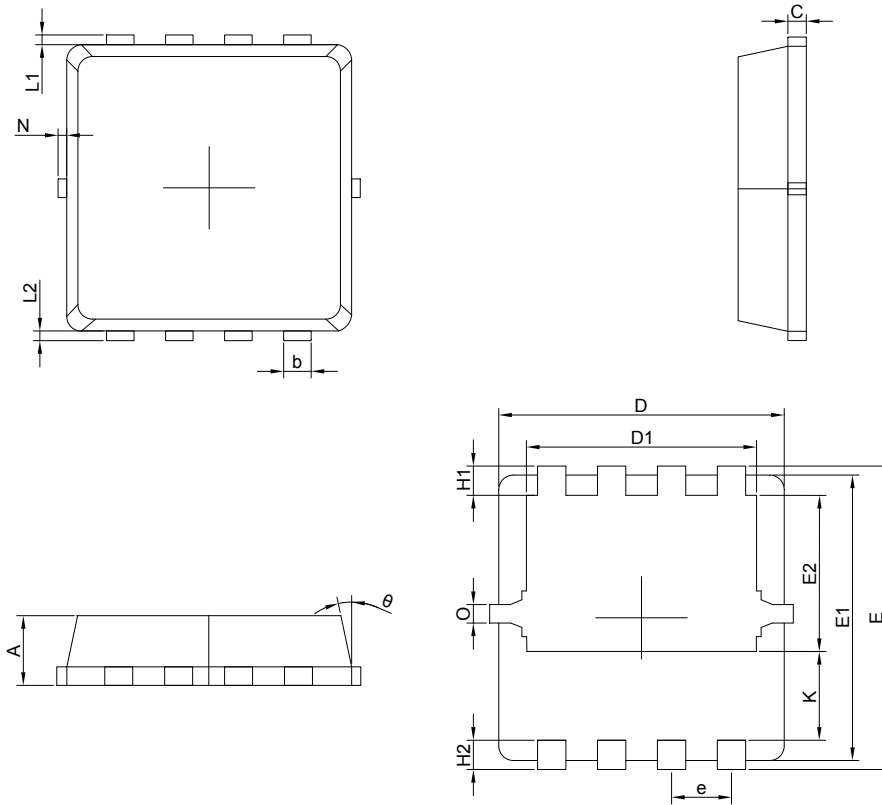

Figure 11. Normalized Maximum Transient Thermal Impedance

8. Dimension (PDFN3*3-8L)



Symbol	Dimensions in Millimeters			Symbol	Dimensions in Millimeters		
	MIN	NOM	MAX		MIN	NOM	MAX
A	0.65	0.75	0.85	e	0.65 BSC.		
b	0.25	0.30	0.35	H1	0.21	0.31	0.41
C	0.15	0.20	0.25	H2	0.30	0.40	0.50
D	3.00	3.10	3.20	K	0.78	0.88	0.98
D1	2.40	2.50	2.60	L1/L2	0.10 REF.		
E	3.20	3.30	3.40	theta	11°	12°	13°
E1	3.00	3.10	3.20	N	0	-	0.15
E2	1.60	1.70	1.80	O	0.2 REF.		

DISCLAIMER

ELECSUPER PROVIDES TECHNICAL AND RELIABILITY DATA (INCLUDING DATASHEETS), DESIGN RESOURCES (INCLUDING REFERENCE DESIGNS), APPLICATION OR OTHER DESIGN ADVICE, SAFETY INFORMATION, AND OTHER RESOURCES “AS IS” AND WITH ALL FAULTS, AND DISCLAIMS ALL WARRANTIES, EXPRESS AND IMPLIED, INCLUDING WITHOUT LIMITATION ANY IMPLIED WARRANTIES OF MERCHANTABILITY, FITNESS FOR A PARTICULAR PURPOSE OR NON-INFRINGEMENT OF THIRD PARTY INTELLECTUAL PROPERTY RIGHTS.

These resources are intended for skilled developers designing with ElecSuper products. You are solely responsible for

- (1) selecting the appropriate ElecSuper products for your application;
- (2) designing, validating and testing your application;
- (3) ensuring your application meets applicable standards, and any other safety, security, or other requirements.

These resources are subject to change without notice. ElecSuper grants you permission to use these resources only for development of an application that uses the ElecSuper products described in the resource. Other reproduction and display of these resources are prohibited. No license is granted to any other ElecSuper intellectual property right or to any third party intellectual property right. ElecSuper disclaims responsibility for, and you will fully indemnify ElecSuper and its representatives against, any claims, damages, costs, losses, and liabilities arising out of your use of these resources. ElecSuper's products are provided subject to ElecSuper's Terms of Sale or other applicable terms available either on www.elecsuper.com or provided in conjunction with such ElecSuper products. ElecSuper's provision of these resources does not expand or otherwise alter ElecSuper's applicable warranties or warranty disclaimers for ElecSuper products.