

## SuperESD - AZ9143-08F-ES

### 1. Description

The AZ9143-08F-ES is an ultra-low capacitance TVS (Transient Voltage Suppressor) array designed to protect high speed data interfaces. It has been specifically designed to protect sensitive electronic components which are connected to data and transmission lines from over-stress caused by ESD (Electrostatic Discharge).

### 2. Features

- IEC 61000-4-2 Level 4 ESD Protection
  - ±15kV Contact Discharge
  - ±15kV Air Discharge
- IEC61000-4-5 (Surge) 6A (8/20µs)
- Protect 8 I/O lines
- Low operating and clamping voltage
- Low leakage current
- Solid-state silicon technology
- Low Junction capacitance: 0.5pF Typ.

### 3. Applications

- USB 2.0
- DVI and HDMI interfaces
- Mobile and cordless phones
- Personal Digital Assistants (PDA)
- Digital cameras
- PCs, notebooks, printers and other PC peripherals

### 4. Ordering Information

Part Number	Package	Marking	Material	Packing	Quantity per reel	Flammability Rating	Reel Size
AZ9143-08F-ES	DFN3810-9L	.3V8U/LOT	Halogen free	Tape & Reel	3,000 PCS	UL 94V-0	7 inches

Table-1 Ordering information

### 5. Pin Configuration and Functions

Pin	Name	Description	Outline	Circuit Diagram
3	GND	Connect to GND		
1/2/4/5/6/7/8/9	IO	Connect to IO		

Table-2 Pin configuration

### 6. Specification

#### 6.1. Absolute Maximum rating

Over operating free-air temperature range (unless otherwise noted)

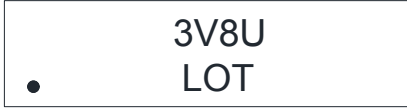
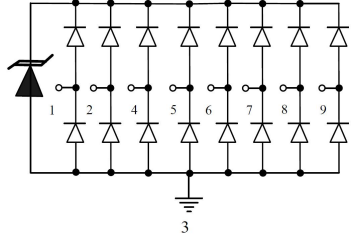
Parameters	Symbol	Min.	Max.	Unit
Peak pulse power (tp=8/20us)@25°C	P <sub>pk</sub>	-	75	W
Peak pulse current (tp=8/20us)@25°C	I <sub>PP</sub>	-	6	A
ESD (IEC61000-4-2 air discharge) @25°C	V <sub>ESD</sub>	-	± 15	kV
ESD (IEC61000-4-2 contact discharge) @25°C	V <sub>ESD</sub>	-	± 15	kV
Junction temperature	T <sub>J</sub>	-	150	°C
Operating temperature	T <sub>OP</sub>	-40	125	°C
Storage temperature	T <sub>STG</sub>	-55	150	°C
Lead temperature	T <sub>L</sub>	-	260	°C

Table-3 Absolute Maximum rating

## 6.2. Electrical Characteristics

At TA = 25°C unless otherwise noted

Parameter	Symbol	Conditions	Min.	Typ.	Max.	Units
Reverse Stand-off Voltage	$V_{RWM}$				3.3	V
Reverse Breakdown Voltage	$V_{BR}$	$I_T=1mA$	4.5		6.0	V
Reverse Leakage Current	$I_R$	$V_{RWM}=3.3V$			1.0	$\mu A$
Clamping Voltage	$V_C$	$I_{PP}=1A$ ; $t_p=8/20\mu s$		6.0	8.0	V
Clamping Voltage	$V_C$	$I_{PP}=6A$ ; $t_p=8/20\mu s$		9.0	12.0	V
Junction Capacitance	$C_J$	$V_R=0V$ ; $f=1MHz$ I/O pin to GND pin		0.5	0.7	pF
Junction Capacitance	$C_J$	$V_R=0V$ ; $f=1MHz$ I/O pin to I/O pin		0.25	0.35	pF

Table-4 Electrical Characteristics

Symbol	Parameters
$V_{RWM}$	Peak Reverse Working Voltage
$I_R$	Reverse Leakage Current @ $V_{RWM}$
$V_{BR}$	Breakdown Voltage @ $I_T$
$I_T$	Test Current
$I_{PP}$	Maximum Reverse Peak Pulse Current
$V_C$	Clamping Voltage @ $I_{PP}$
$I_F$	Forward Current
$V_F$	Forward Voltage @ $I_F$

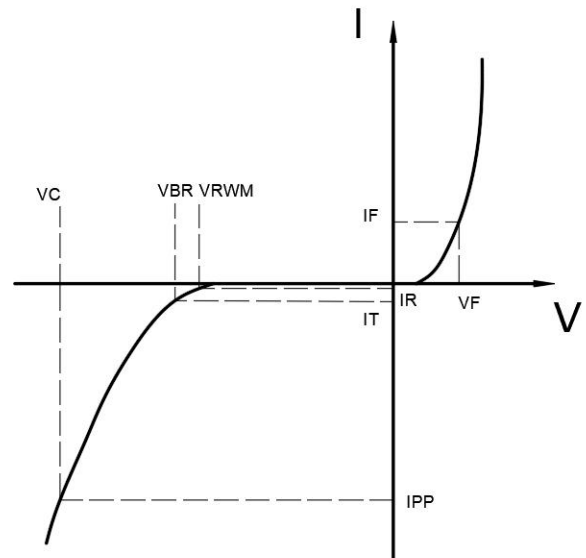

**7. Typical Characteristic**

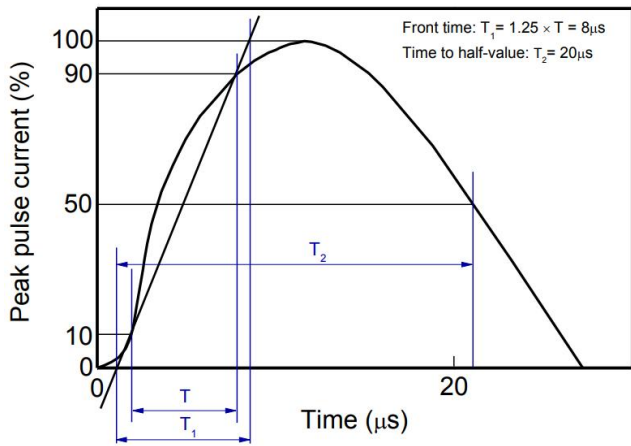

8/20μs waveform per IEC61000-4-5

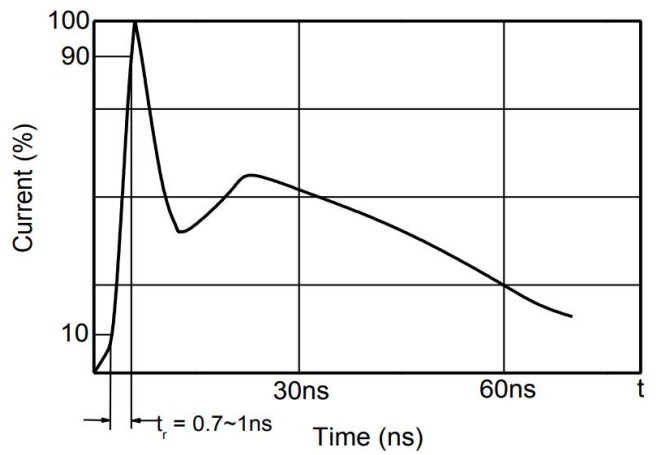

Contact discharge current waveform per IEC61000-4-2

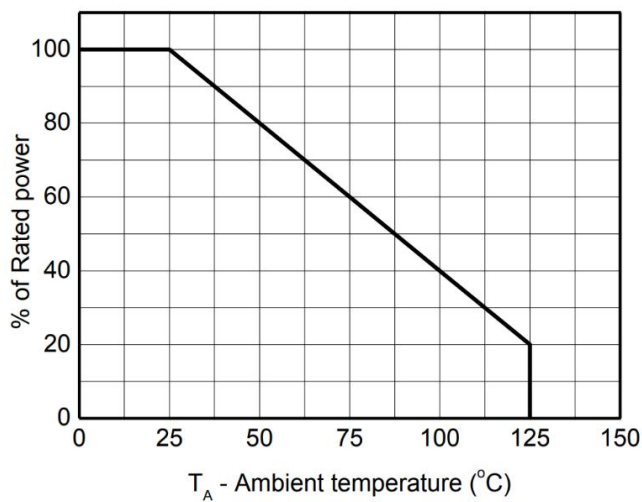

Power derating vs. Ambient temperature

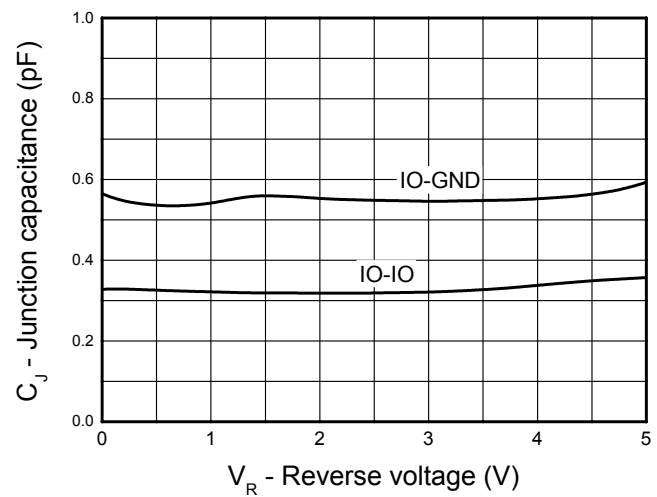

Capacitance vs. Reverse voltage

8. Dimension (DFN3810-9L)

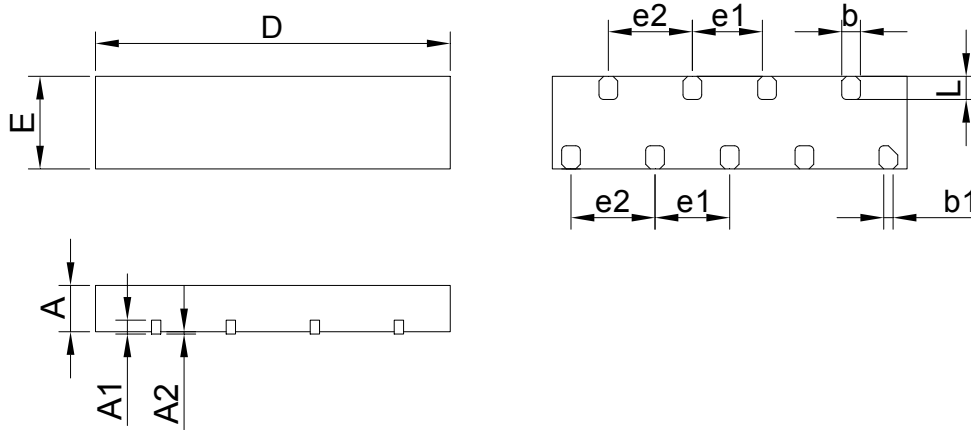

Symbol	Dimensions in Millimeters		
	MIN	NOM	MAX
D	3.75	3.80	3.00
E	0.95	1.00	1.05
L	0.20	0.25	0.30
b	0.15	0.20	0.25
b1	0.05	0.10	0.15
e1	0.80BSC		
e2	0.90BSC		
A	0.45	0.50	0.55
A1	0.152REF		
A2	-	0.00	0.05

**DISCLAIMER**

ELECSUPER SUPERESD PROVIDES TECHNICAL AND RELIABILITY DATA (INCLUDING DATASHEETS), DESIGN RESOURCES (INCLUDING REFERENCE DESIGNS), APPLICATION OR OTHER DESIGN ADVICE, SAFETY INFORMATION, AND OTHER RESOURCES "AS IS" AND WITH ALL FAULTS, AND DISCLAIMS ALL WARRANTIES, EXPRESS AND IMPLIED, INCLUDING WITHOUT LIMITATION ANY IMPLIED WARRANTIES OF MERCHANTABILITY, FITNESS FOR A PARTICULAR PURPOSE OR NON-INFRINGEMENT OF THIRD PARTY INTELLECTUAL PROPERTY RIGHTS.

These resources are intended for skilled developers designing with ElecSuper products. You are solely responsible for

- (1) selecting the appropriate ElecSuper products for your application;
- (2) designing, validating and testing your application;
- (3) ensuring your application meets applicable standards, and any other safety, security, or other requirements.

These resources are subject to change without notice. ElecSuper grants you permission to use these resources only for development of an application that uses the ElecSuper products described in the resource. Other reproduction and display of these resources are prohibited. No license is granted to any other ElecSuper intellectual property right or to any third party intellectual property right. ElecSuper disclaims responsibility for, and you will fully indemnify ElecSuper and its representatives against, any claims, damages, costs, losses, and liabilities arising out of your use of these resources. ElecSuper's products are provided subject to ElecSuper's Terms of Sale or other applicable terms available either on [www.elecsuper.com](http://www.elecsuper.com) or provided in conjunction with such ElecSuper products. ElecSuper's provision of these resources does not expand or otherwise alter ElecSuper's applicable warranties or warranty disclaimers for ElecSuper products.