

1. Designed for long haul 2.5G Single Port Transformer Module
2. Supports four pairs of category 5 UTP cable, Cable interface for isolation and low common mode emissions.
3. Low profile Surface Mount Packaging designed for Hi-Temp Reflow Process
4. Compliant with IEEE 802.3bz standard for 2.5G Base-Z, Designed to support 1:1 Turns Ratio Transceivers.

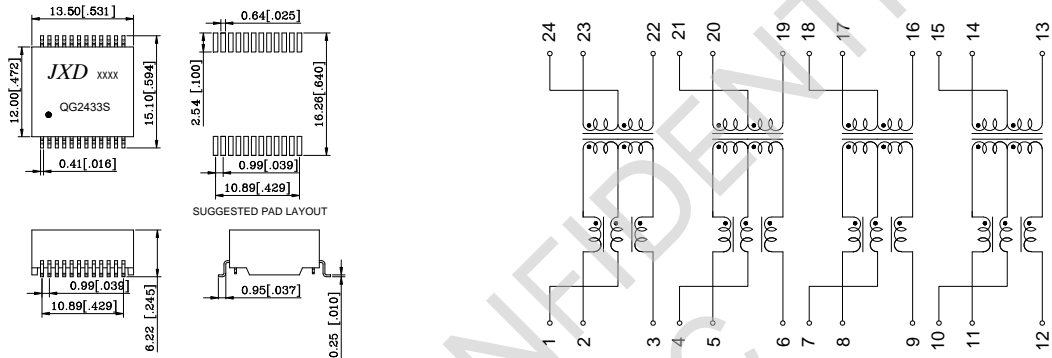

DIMENSIONS & SCHEMATICS



TECHNICAL SPECIFICATIONS

OCL :	180 μ H Min. @ 100 KHz, 100mV with 8mA DC Bias
Leakage Inductance:	0.5 μ H Max. @ 100KHz, 0.2V
Cw/w:	28 pF Max. @ 100KHz, 0.2V
DCR:	1.00 Ω Max
Turns Ratio(\pm 5%):	1CT:1(TX), 1CT:1(RX)
Polarity:	2-23, 5-20, 8-17, 11-14 In-Phase
Insertion Loss:	-1.0 dB Max. @ 1-125MHz
Return Loss:	-20 dB Min. @ 1-40MHz
	-16 + 10*Log(f/40) dB Min. @ 40-250MHz
Cross Talk:	-30 dB Min. @ 1-125 MHz
Common Mode Rejection :	-25dB Min. @ 1-125 MHz
Isolation HI-POT:	1500Vrms 1mA 1Second
Operating Temperature range:	-40 $^{\circ}$ C ~ +85 $^{\circ}$ C
Storage temperature range:	-25 $^{\circ}$ C ~ +125 $^{\circ}$ C

PACKING SPECIFICATION

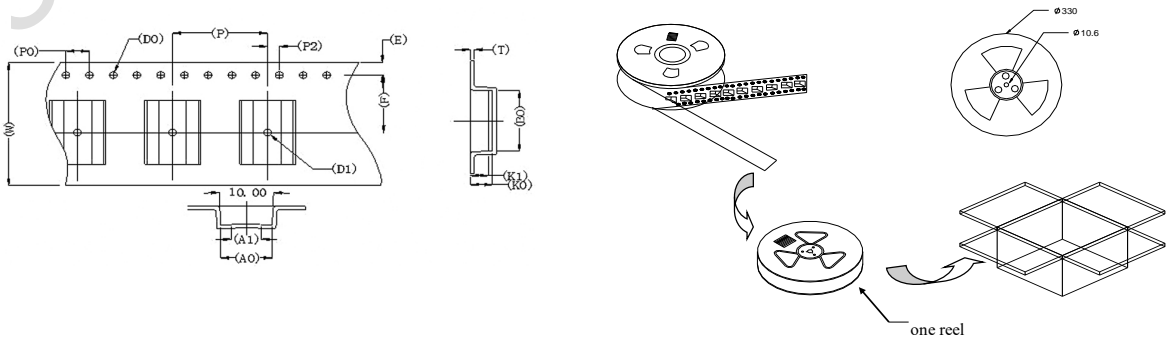

1. units/reel:350PCS
- 2 reel/carton:10PCS
- 3.units/carton :3500PCS