

Description

The SP0504S has ultra low capacitance rail-to-rail diodes with an additional zener diode fabricated in a proprietary silicon avalanche technology to protect each I/O pin providing a high level of protection for electronic equipment that may experience destructive electrostatic discharges (ESD). These robust diodes can safely absorb repetitive ESD strikes at the maximum level (Level 4) specified in the IEC 61000-4-2 international standard without performance degradation. Their very low loading capacitance also makes them ideal for protecting high speed signal pins such as HDMI, DVI, USB2.0, and IEEE 1394.

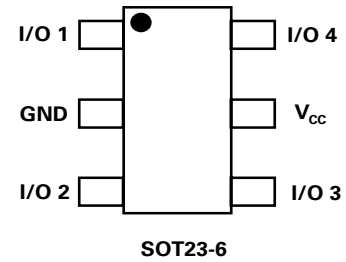

Features

- Low capacitance of 0.85 pF (TYP) per I/O
- ESD protection of $\pm 12\text{kV}$ contact discharge, $\pm 15\text{kV}$ air discharge, (IEC 61000-4-2)
- EFT protection, IEC 61000-4-4, 40A (5/50ns)
- Low leakage current of $0.5\mu\text{A}$ (MAX) at 5V
- Small packaging options saves board space
- Lightning Protection, IEC 61000-4-5, 4.5A (8/20 μs)

Applications

- Computer Peripherals
- Mobile Phones
- PDA's
- Digital Cameras
- Network Hardware/Ports
- Test Equipment
- Medical Equipment
- Automotive Network

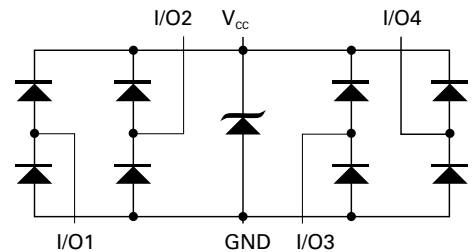

Absolute Maximum Ratings

Symbol	Parameter	Value	Units
I_{PP}	Peak Current ($t_p=8/20\mu s$)	4.5	A
T_{OP}	Operating Temperature	-40 to 125	°C
T_{STOR}	Storage Temperature	-55 to 150	°C

CAUTION: Stresses above those listed in "Absolute Maximum Ratings" may cause permanent damage to the device. This is a stress only rating and operation of the device at these or any other conditions above those indicated in the operational sections of this specification is not implied.

Thermal Information

Parameter	Rating	Units
Storage Temperature Range	-55 to 150	°C
Maximum Junction Temperature	150	°C
Maximum Lead Temperature (Soldering 20-40s)	260	°C

Electrical Characteristics($T_{OP}=25^\circ C$)

Parameter	Symbol	Test Conditions	Min	Typ	Max	Units
Reverse Standoff Voltage	V_{RWM}	$I_R \leq 1\mu A$			6.0	V
Reverse Leakage Current	I_{LEAK}	$V_R=5V$			0.5	μA
Clamp Voltage ¹	V_C	$I_{PP}=1A, t_p=8/20\mu s, Fwd$		9.5	11.0	V
		$I_{PP}=2A, t_p=8/20\mu s, Fwd$		10.6	13.0	V
ESD Withstand Voltage ¹	V_{ESD}	IEC 61000-4-2 (Contact)	± 12			kV
		IEC 61000-4-2 (Air)	± 15			kV
Diode Capacitance ¹	$C_{I/O-GND}$	Reverse Bias=0V	0.95	1.1	1.25	pF
		Reverse Bias=1.65V	0.7	0.85	1.0	pF
Diode Capacitance ¹	$C_{I/O-I/O}$	Reverse Bias=0V		0.5		pF

Note: 1. Parameter is guaranteed by design and/or device characterization.

Insertion Loss (S21) I/O to GND

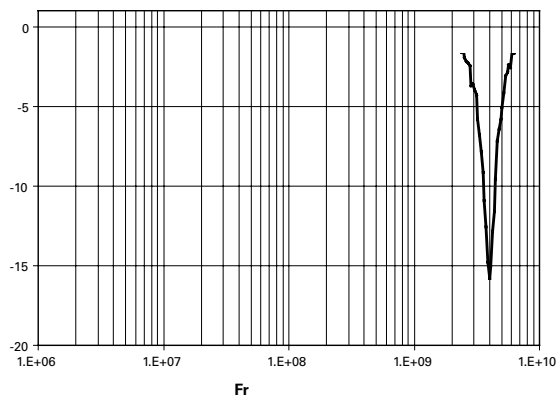

Capacitance vs. Bias Voltage

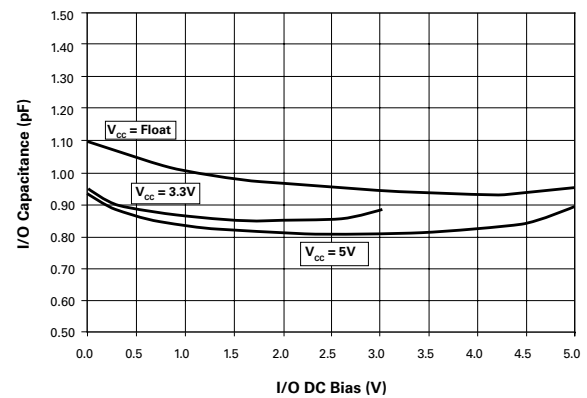

Capacitance vs. Frequency

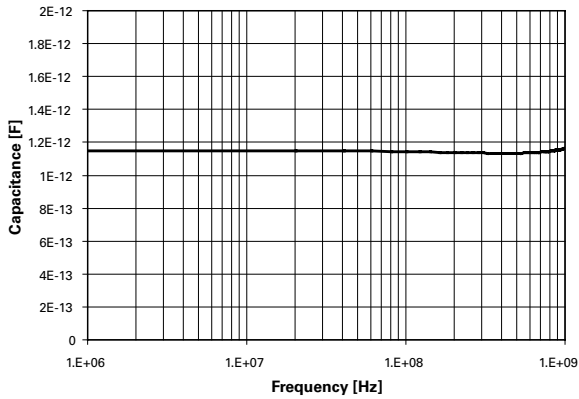

Product Characteristics

Lead Plating	Matte Tin
Lead Material	Copper Alloy
Lead Coplanarity	0.0004 inches (0.102mm)
Substitute Material	Silicon
Body Material	Molded Epoxy
Flammability	UL 94 V-0

- Notes :
1. All dimensions are in millimeters
 2. Dimensions include solder plating.
 3. Dimensions are exclusive of mold flash & metal burr.
 4. Blo is facing up for mold and facing down for trim/form, i.e. reverse trim/form.

Soldering Parameters

Reflow Condition		Pb – Free assembly
Pre Heat	-Temperature Min ($T_{s(min)}$)	150°C
	-Temperature Max ($T_{s(max)}$)	200°C
	-Time (min to max) (t_s)	60 – 180 secs
Average ramp up rate (Liquidus) Temp (T_L) to peak		3°C/second max
$T_{s(max)}$ to T_L - Ramp-up Rate		3°C/second max
Reflow	-Temperature (T_L) (Liquidus)	217°C
	-Temperature (t_L)	60 – 150 seconds
Peak Temperature (T_p)		260 ^{+0/-5} °C
Time within 5°C of actual peak Temperature (t_p)		20 – 40 seconds
Ramp-down Rate		6°C/second max
Time 25°C to peak Temperature (T_p)		8 minutes Max.
Do not exceed		260°C

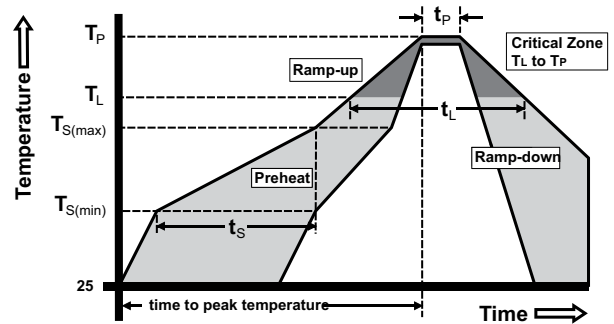

SOT23-6

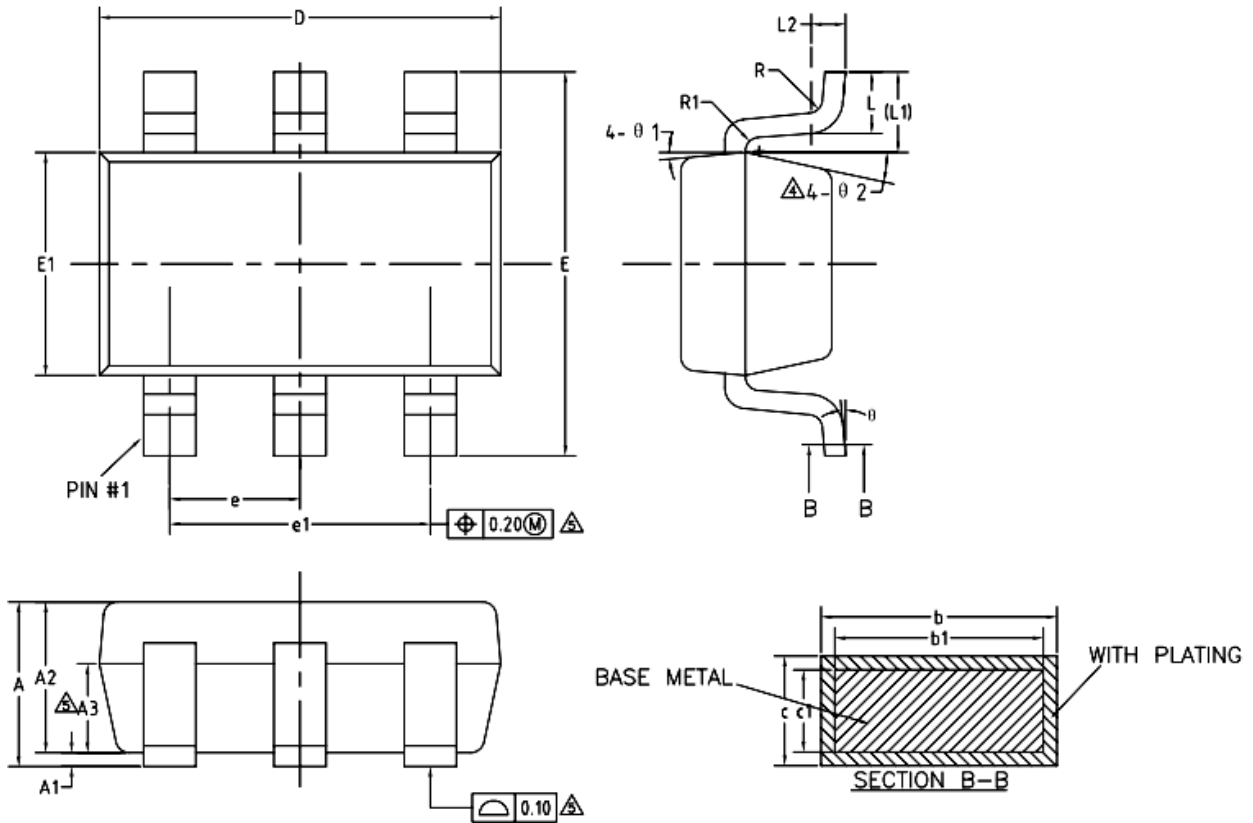

COMMON DIMENSIONS
(UNITS OF MEASURE=MILLIMETER)

SYMBOL	MIN	NOM	MAX
A	—	—	1.25
A1	0	—	0.15
A2	1.00	1.10	1.20
A3	0.60	0.65	0.70
b	0.36	—	0.50
b1	0.36	0.38	0.45
c	0.14	—	0.20
c1	0.14	0.15	0.16
D	2.826	2.926	3.026
E	2.60	2.80	3.00
E1	1.526	1.626	1.726
e	0.90	0.95	1.00
e1	1.80	1.90	2.00
L	0.35	0.45	0.60
L1	0.59REF		
L2	0.25BSC		
R	0.10	—	—
R1	0.10	—	0.20
θ	0° — 8°		
θ 1	3°	5°	7°
θ 2	6°	—	14°

Marking

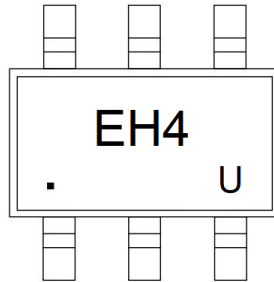

Ordering information

Order code	Package	Base qty	Delivery mode
UMW SP0504SHTG	SOT23-6	3000	Tape and reel