



### Features

- 3rd generation SiC MOSFET technology
- High blocking voltage with low on-resistance
- High-speed switching with low capacitances
- Fast intrinsic diode with low reverse recovery ( $Q_{rr}$ )
- Halogen free, RoHS compliant

### Benefits

- Reduce switching losses and minimize gate ringing
- Higher system efficiency
- Reduce cooling requirements
- Increase power density
- Increase system switching frequency

### Applications

- Solar inverters
- EV motor drive
- High voltage DC/DC converters
- Switched mode power supplies
- Load switch

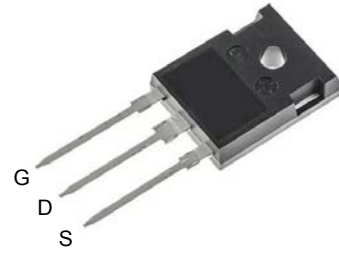

TO247-3L  
Package

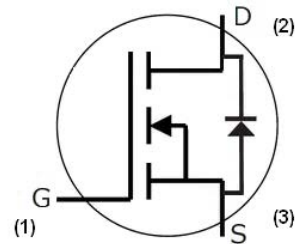

Part Number	Package	Marking
HC3M0016120D	TO247-3L	HC3M0016120D

### Maximum Ratings ( $T_c = 25^\circ\text{C}$ unless otherwise specified)

Symbol	Parameter	Value	Unit	Test Conditions	Note
$V_{DSmax}$	Drain - Source Voltage	1200	V	$V_{GS} = 0\text{ V}, I_D = 100\ \mu\text{A}$	
$V_{GSmax}$	Gate - Source Voltage (dynamic)	-8/+19	V	AC ( $f > 1\text{ Hz}$ )	Note 1
$V_{GSop}$	Gate - Source Voltage (static)	-4/+15	V	Static	Note 2
$I_D$	Continuous Drain Current	115	A	$V_{GS} = 15\text{ V}, T_c = 25^\circ\text{C}$	Fig. 19
		85		$V_{GS} = 15\text{ V}, T_c = 100^\circ\text{C}$	
$I_{D(pulse)}$	Pulsed Drain Current	250	A	Pulse width $t_p$ limited by $T_{Jmax}$	
$P_D$	Power Dissipation	556	W	$T_c = 25^\circ\text{C}, T_J = 175^\circ\text{C}$	Fig. 20
$T_J, T_{stg}$	Operating Junction and Storage Temperature	-40 to +175	$^\circ\text{C}$		
$T_L$	Solder Temperature	260	$^\circ\text{C}$	1.6mm (0.063") from case for 10s	
$M_d$	Mounting Torque	1	Nm	M3 or 6-32 screw	
		8.8			

Note (1): When using MOSFET Body Diode  $V_{GSmax} = -4\text{V}/+19\text{V}$

Note (2): MOSFET can also safely operate at  $0/+15\text{ V}$



**Electrical Characteristics** ( $T_c = 25^\circ\text{C}$  unless otherwise specified)

Symbol	Parameter	Min.	Typ.	Max.	Unit	Test Conditions	Note
$V_{(BR)DSS}$	Drain-Source Breakdown Voltage	1200			V	$V_{GS} = 0\text{ V}, I_D = 100\ \mu\text{A}$	
$V_{GS(th)}$	Gate Threshold Voltage	1.8	2.5	3.6	V	$V_{DS} = V_{GS}, I_D = 23\ \text{mA}$	Fig. 11
			2.0		V	$V_{DS} = V_{GS}, I_D = 23\ \text{mA}, T_J = 175^\circ\text{C}$	
$I_{DSS}$	Zero Gate Voltage Drain Current		1	50	$\mu\text{A}$	$V_{DS} = 1200\ \text{V}, V_{GS} = 0\ \text{V}$	
$I_{GSS}$	Gate-Source Leakage Current		10	250	nA	$V_{GS} = 15\ \text{V}, V_{DS} = 0\ \text{V}$	
$R_{DS(on)}$	Drain-Source On-State Resistance	11.2	16	22.3	m $\Omega$	$V_{GS} = 15\ \text{V}, I_D = 75\ \text{A}$	Fig. 4, 5, 6
			28.8			$V_{GS} = 15\ \text{V}, I_D = 75\ \text{A}, T_J = 175^\circ\text{C}$	
$g_{fs}$	Transconductance		53		S	$V_{DS} = 20\ \text{V}, I_{DS} = 75\ \text{A}$	Fig. 7
			47			$V_{DS} = 20\ \text{V}, I_{DS} = 75\ \text{A}, T_J = 175^\circ\text{C}$	
$C_{iss}$	Input Capacitance		6085		pF	$V_{GS} = 0\ \text{V}, V_{DS} = 1000\ \text{V}$ $f = 100\ \text{KHz}$ $V_{AC} = 25\ \text{mV}$	Fig. 17, 18
$C_{oss}$	Output Capacitance		230				
$C_{riss}$	Reverse Transfer Capacitance		13				
$E_{oss}$	$C_{oss}$ Stored Energy		130				$\mu\text{J}$
$E_{ON}$	Turn-On Switching Energy (SiC Diode FWD)		4.64		mJ	$V_{DS} = 800\ \text{V}, V_{GS} = -4\ \text{V}/+15\ \text{V}, I_D = 75\ \text{A},$ $R_{G(ext)} = 5\ \Omega, L = 65.7\ \mu\text{H}, T_J = 175^\circ\text{C}$	Fig. 26
$E_{OFF}$	Turn Off Switching Energy (SiC Diode FWD)		2.93				
$E_{ON}$	Turn-On Switching Energy (Body Diode FWD)		7.79		mJ	$V_{DS} = 800\ \text{V}, V_{GS} = -4\ \text{V}/+15\ \text{V}, I_D = 75\ \text{A},$ $R_{G(ext)} = 5\ \Omega, L = 65.7\ \mu\text{H}, T_J = 175^\circ\text{C}$	Fig. 26
$E_{OFF}$	Turn Off Switching Energy (Body Diode FWD)		2.95				
$t_{d(on)}$	Turn-On Delay Time		174		ns	$V_{DD} = 800\ \text{V}, V_{GS} = -4\ \text{V}/15\ \text{V}$ $R_{G(ext)} = 5\ \Omega, I_D = 75\ \text{A}, L = 65.7\ \mu\text{H}$ Timing relative to $V_{DS}$ , Inductive load	Fig. 27
$t_r$	Rise Time		28				
$t_{d(off)}$	Turn-Off Delay Time		84				
$t_f$	Fall Time		27				
$R_{G(int)}$	Internal Gate Resistance		2.6		$\Omega$	$f = 1\ \text{MHz}, V_{AC} = 25\ \text{mV}$	
$Q_{gs}$	Gate to Source Charge		70		nC	$V_{DS} = 800\ \text{V}, V_{GS} = -4\ \text{V}/15\ \text{V}$ $I_D = 75\ \text{A}$ Per IEC60747-8-4 pg 21	Fig. 12
$Q_{gd}$	Gate to Drain Charge		60				
$Q_g$	Total Gate Charge		207				



**Reverse Diode Characteristics** ( $T_c = 25^\circ\text{C}$  unless otherwise specified)

Symbol	Parameter	Typ.	Max.	Unit	Test Conditions	Note
$V_{SD}$	Diode Forward Voltage	4.6		V	$V_{GS} = -4\text{ V}, I_{SD} = 37.5\text{ A}, T_J = 25^\circ\text{C}$	Fig. 8, 9, 10
		4.2		V	$V_{GS} = -4\text{ V}, I_{SD} = 37.5\text{ A}, T_J = 175^\circ\text{C}$	
$I_S$	Continuous Diode Forward Current		112	A	$V_{GS} = -4\text{ V}, T_c = 25^\circ\text{C}$	Note 1
$I_{S, pulse}$	Diode pulse Current		250	A	$V_{GS} = -4\text{ V}$ , pulse width $t_p$ limited by $T_{Jmax}$	Note 1
$t_{rr}$	Reverse Recover time	96		ns	$V_{GS} = -4\text{ V}, I_{SD} = 75\text{ A}, V_R = 800\text{ V}$ $\text{dif}/\text{dt} = 900\text{ A}/\mu\text{s}, T_J = 175^\circ\text{C}$	Note 1
$Q_{rr}$	Reverse Recovery Charge	604		nC		
$I_{rrm}$	Peak Reverse Recovery Current	15		A		
$t_{rr}$	Reverse Recover time	58		ns	$V_{GS} = -4\text{ V}, I_{SD} = 75\text{ A}, V_R = 800\text{ V}$ $\text{dif}/\text{dt} = 1400\text{ A}/\mu\text{s}, T_J = 175^\circ\text{C}$	Note 1
$Q_{rr}$	Reverse Recovery Charge	672		nC		
$I_{rrm}$	Peak Reverse Recovery Current	22		A		

**Thermal Characteristics**

Symbol	Parameter	Typ.	Unit	Test Conditions	Note
$R_{\theta JC}$	Thermal Resistance from Junction to Case	0.27	$^\circ\text{C}/\text{W}$		Fig. 21
$R_{\theta JA}$	Thermal Resistance From Junction to Ambient	40			



### Typical Performance

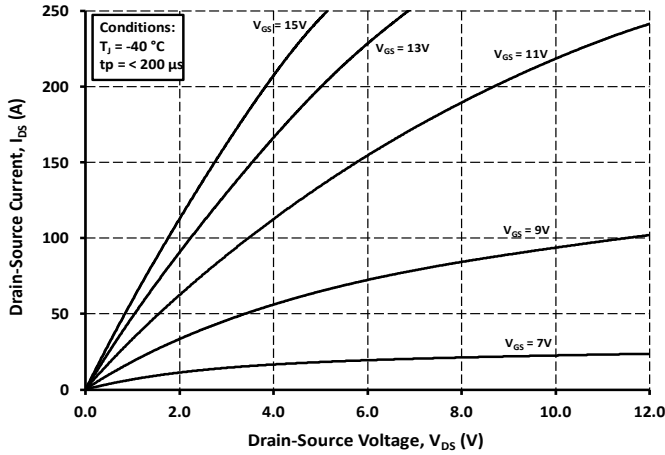

Figure 1. Output Characteristics  $T_J = -40\text{ }^\circ\text{C}$

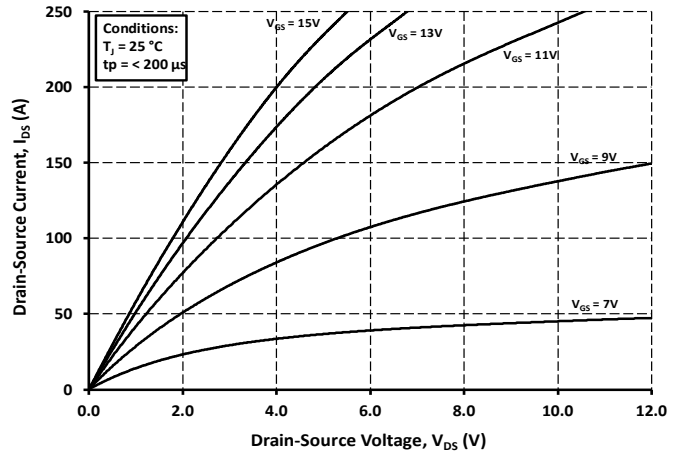

Figure 2. Output Characteristics  $T_J = 25\text{ }^\circ\text{C}$

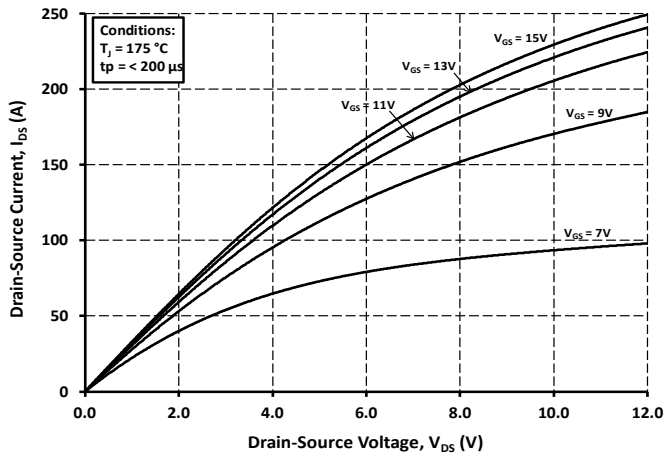

Figure 3. Output Characteristics  $T_J = 175\text{ }^\circ\text{C}$

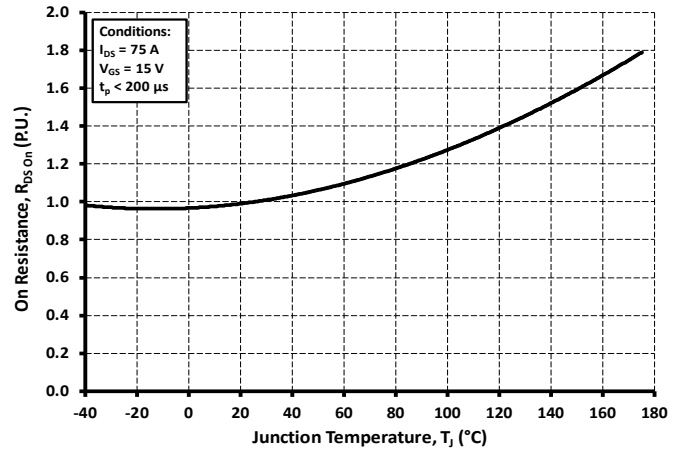

Figure 4. Normalized On-Resistance vs. Temperature

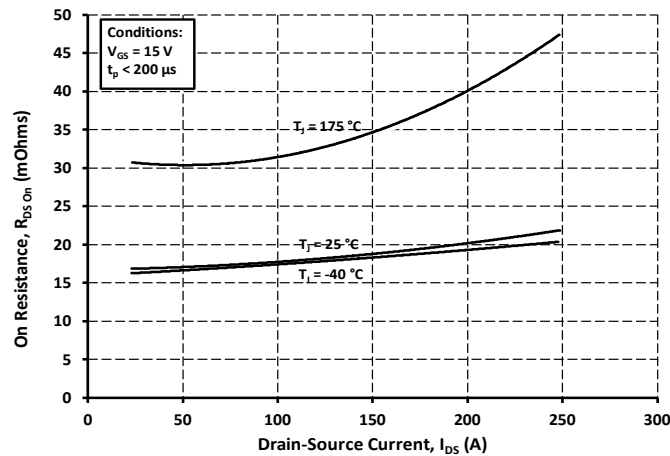

Figure 5. On-Resistance vs. Drain Current For Various Temperatures

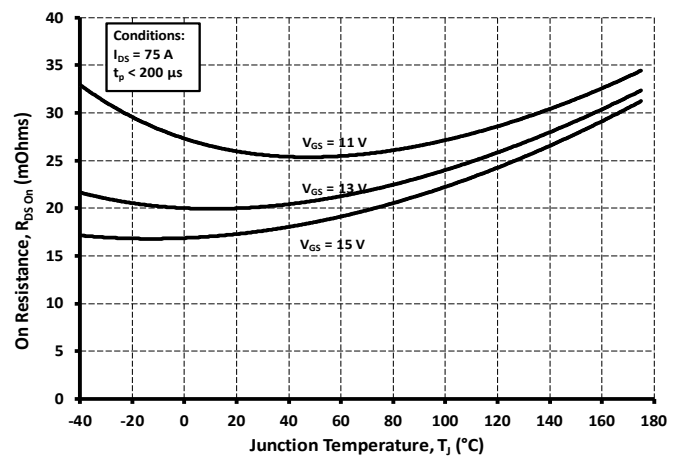

Figure 6. On-Resistance vs. Temperature For Various Gate Voltage



### Typical Performance

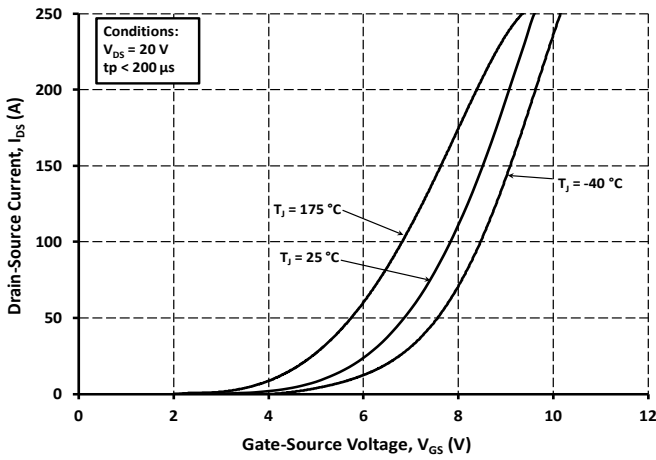

Figure 7. Transfer Characteristic for Various Junction Temperatures

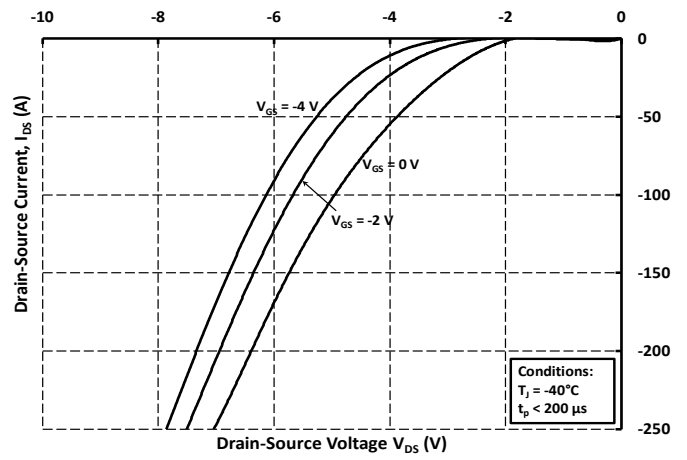

Figure 8. Body Diode Characteristic at  $-40\text{ °C}$

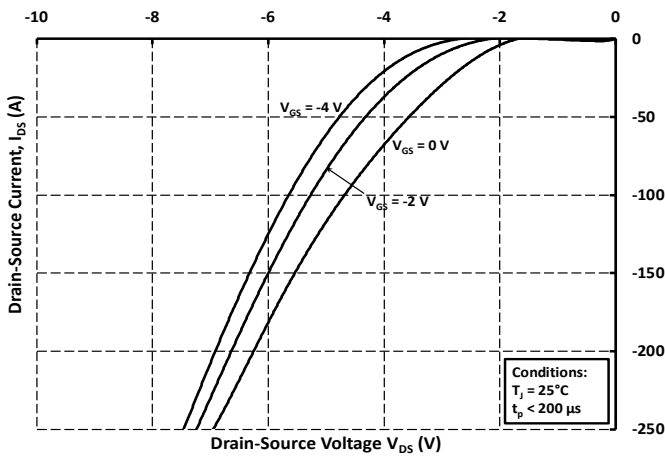

Figure 9. Body Diode Characteristic at  $25\text{ °C}$

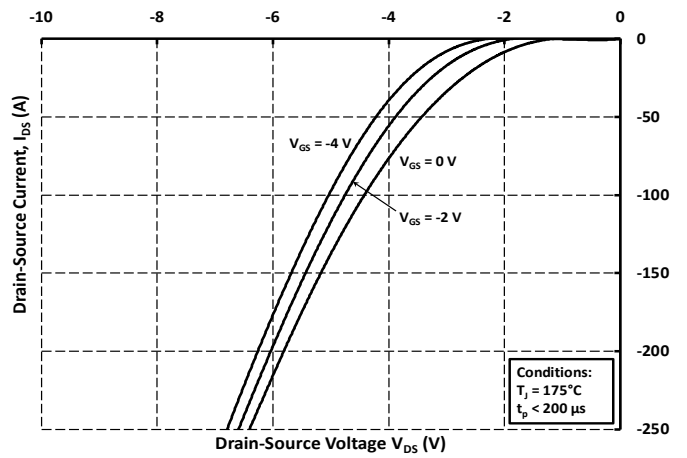

Figure 10. Body Diode Characteristic at  $175\text{ °C}$

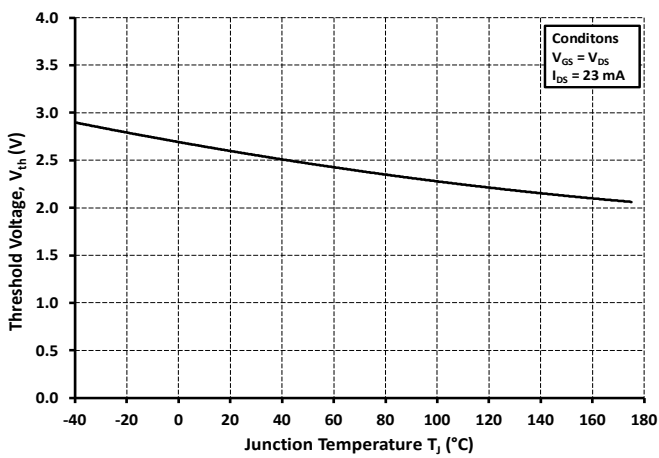

Figure 11. Threshold Voltage vs. Temperature

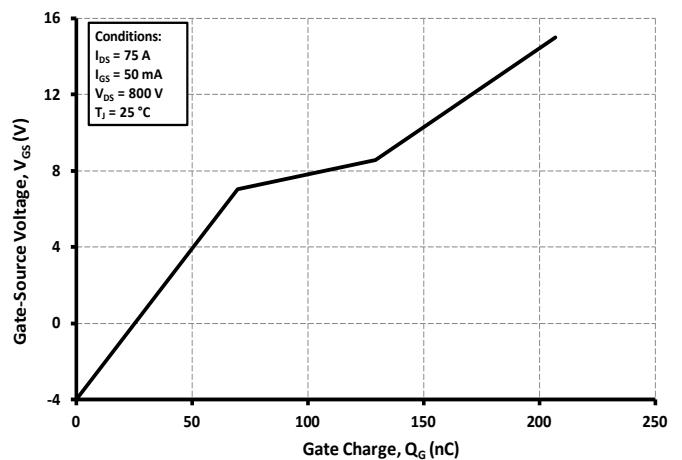

Figure 12. Gate Charge Characteristics



### Typical Performance

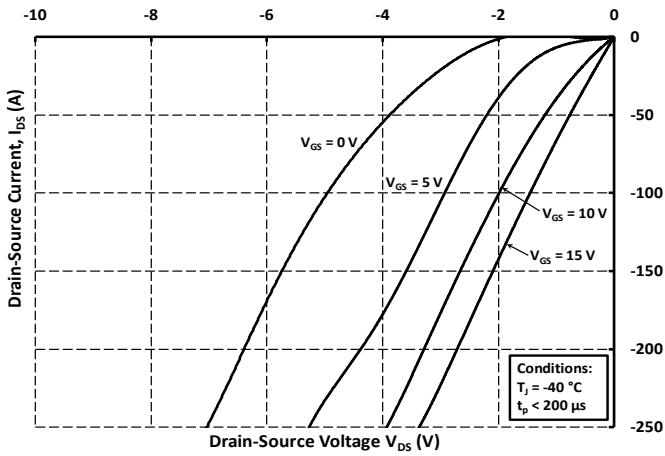

Figure 13. 3rd Quadrant Characteristic at -40 °C

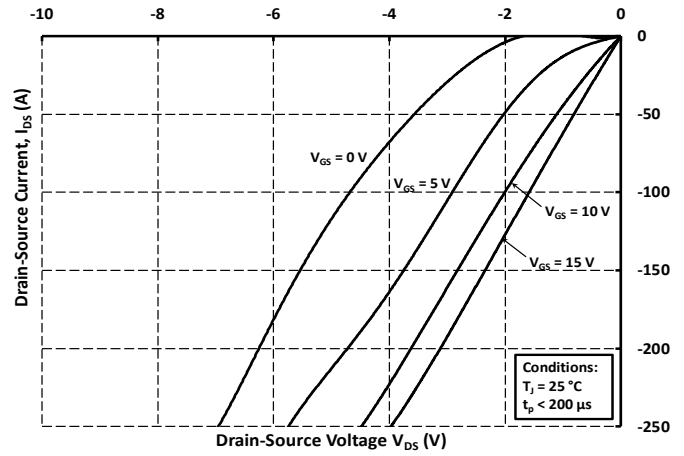

Figure 14. 3rd Quadrant Characteristic at 25 °C

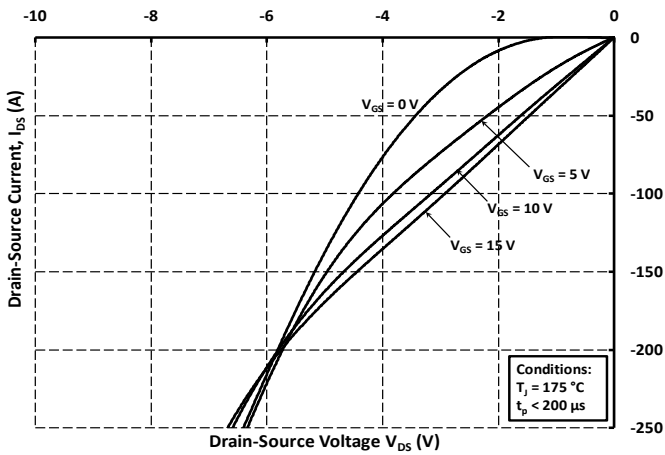

Figure 15. 3rd Quadrant Characteristic at 175 °C

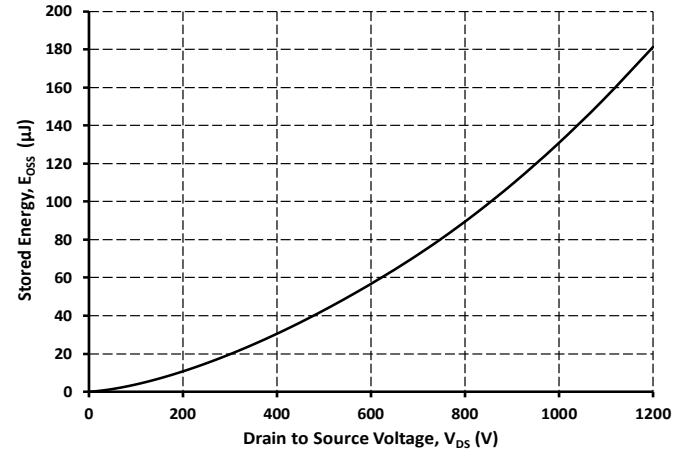

Figure 16. Output Capacitor Stored Energy

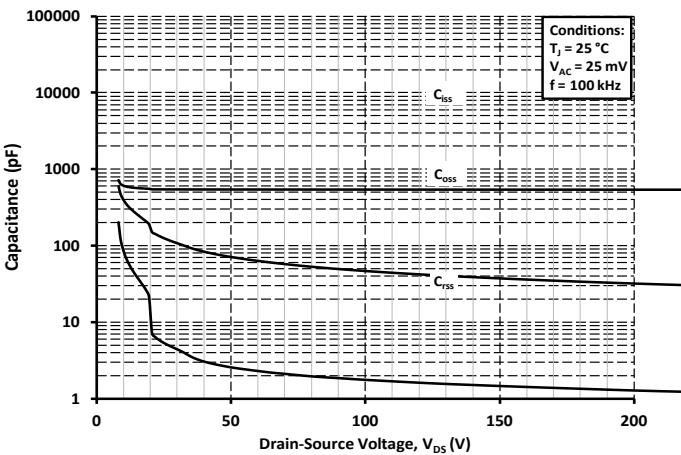

Figure 17. Capacitances vs. Drain-Source Voltage (0 - 200V)

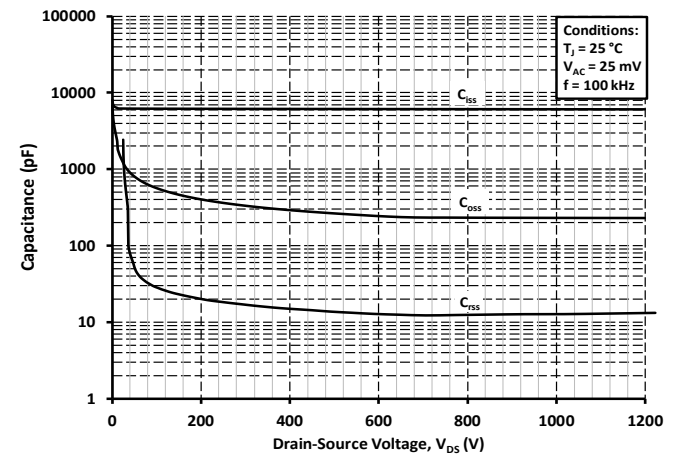

Figure 18. Capacitances vs. Drain-Source Voltage (0 - 1200V)



Typical Performance

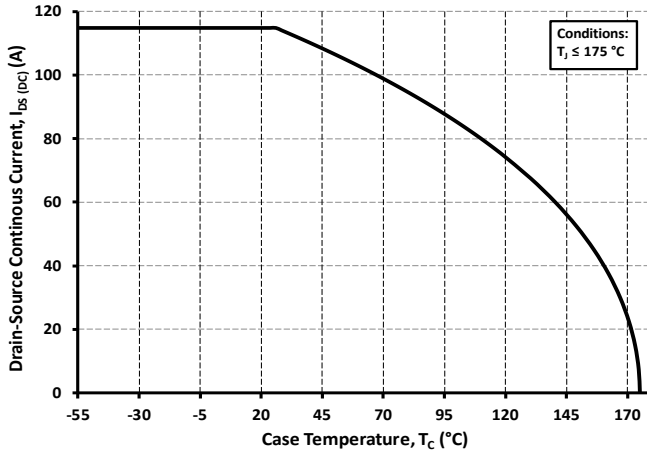

Figure 19. Continuous Drain Current Derating vs. Case Temperature

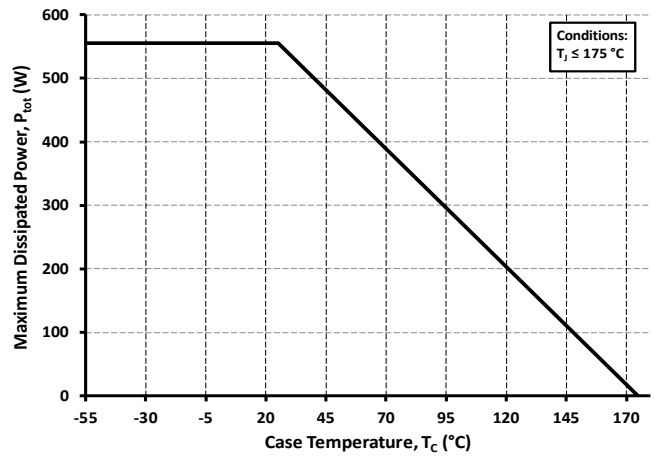

Figure 20. Maximum Power Dissipation Derating vs. Case Temperature

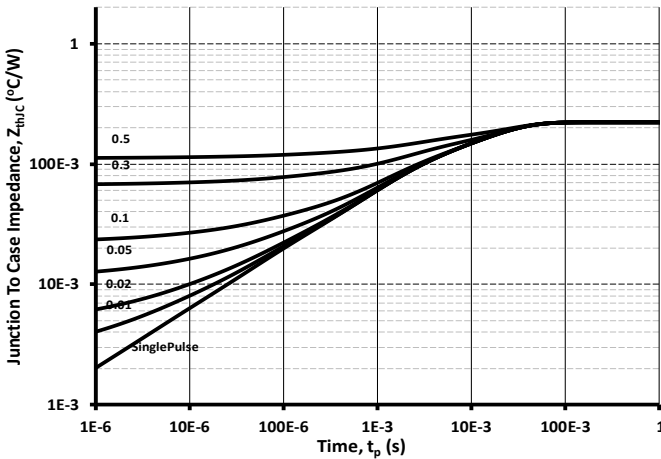

Figure 21. Transient Thermal Impedance (Junction - Case)

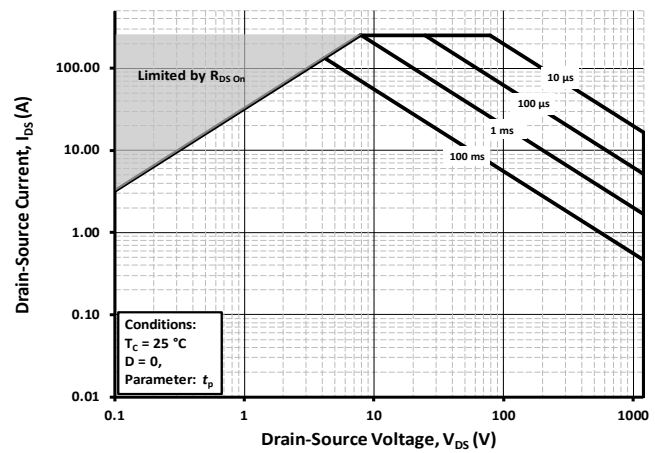

Figure 22. Safe Operating Area

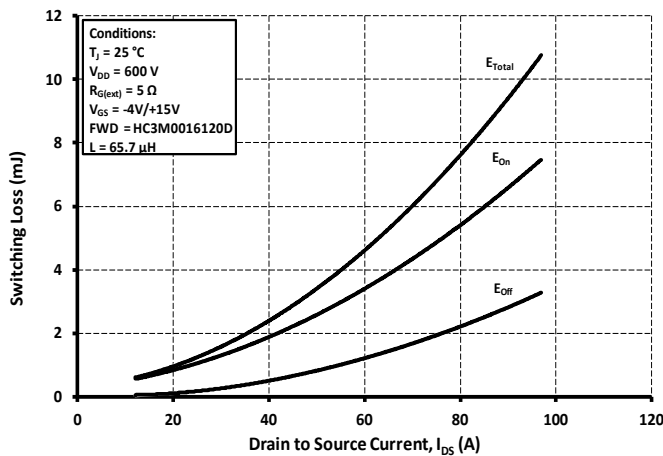

Figure 23. Clamped Inductive Switching Energy vs. Drain Current ( $V_{DD} = 600V$ )

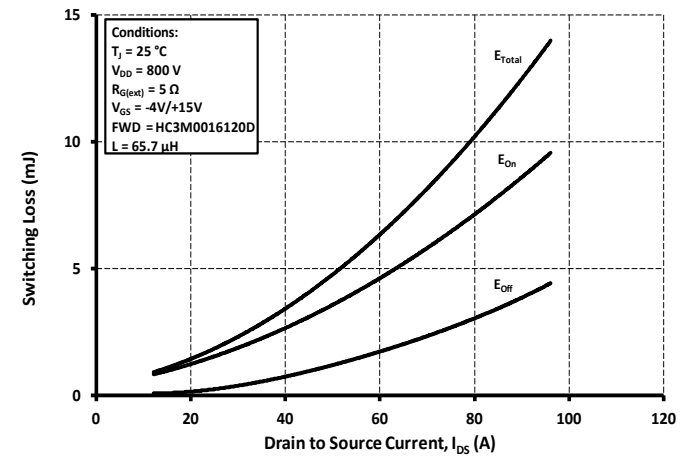

Figure 24. Clamped Inductive Switching Energy vs. Drain Current ( $V_{DD} = 800V$ )



### Typical Performance

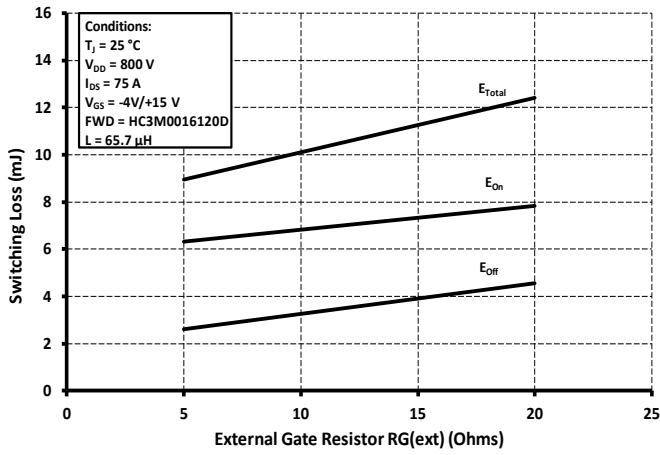

Figure 25. Clamped Inductive Switching Energy vs.  $R_{G(ext)}$

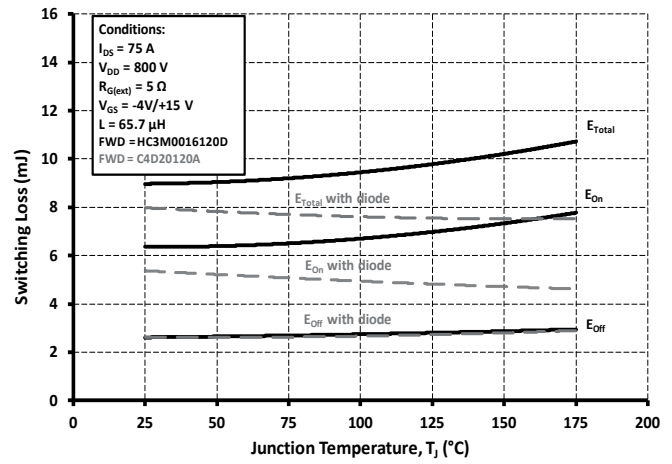

Figure 26. Clamped Inductive Switching Energy vs. Temperature

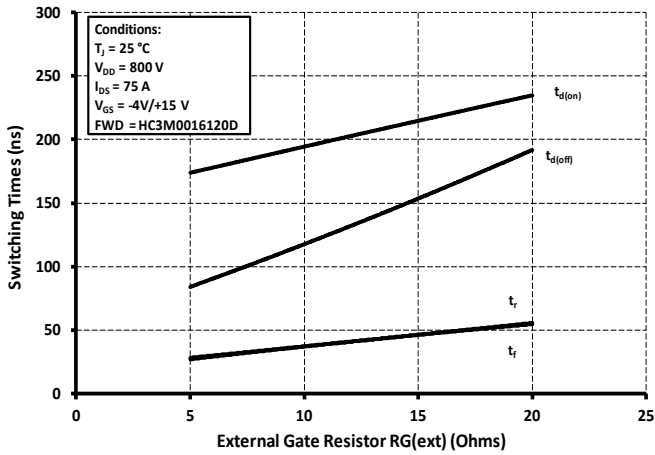

Figure 27. Switching Times vs.  $R_{G(ext)}$

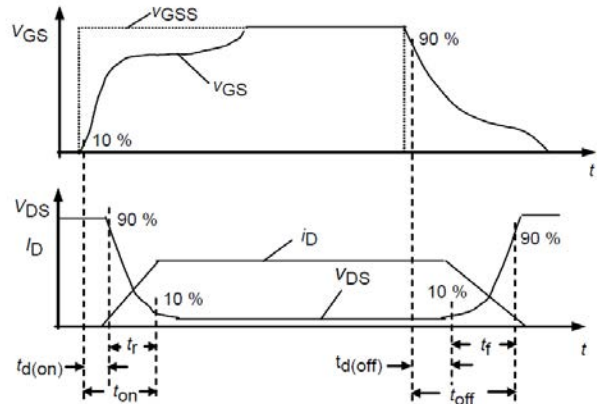

Figure 28. Switching Times Definition





### Test Circuit Schematic

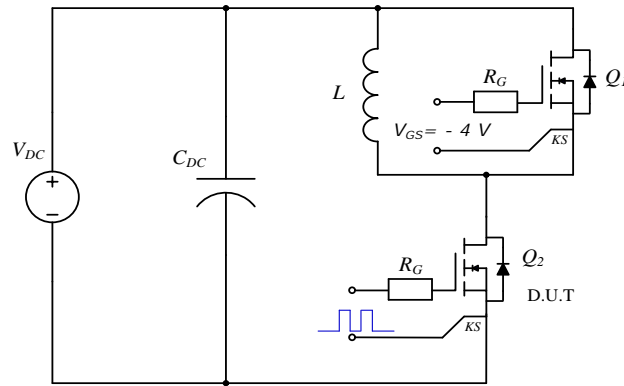

Figure 29. Clamped Inductive Switching  
Waveform Test Circuit

Note (3): Turn-off and Turn-on switching energy and timing values measured using SiC MOSFET Body Diode as shown above.



### Package Dimensions

#### Package T0247-3L

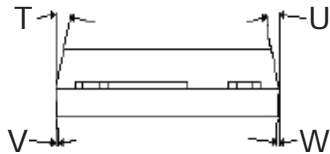
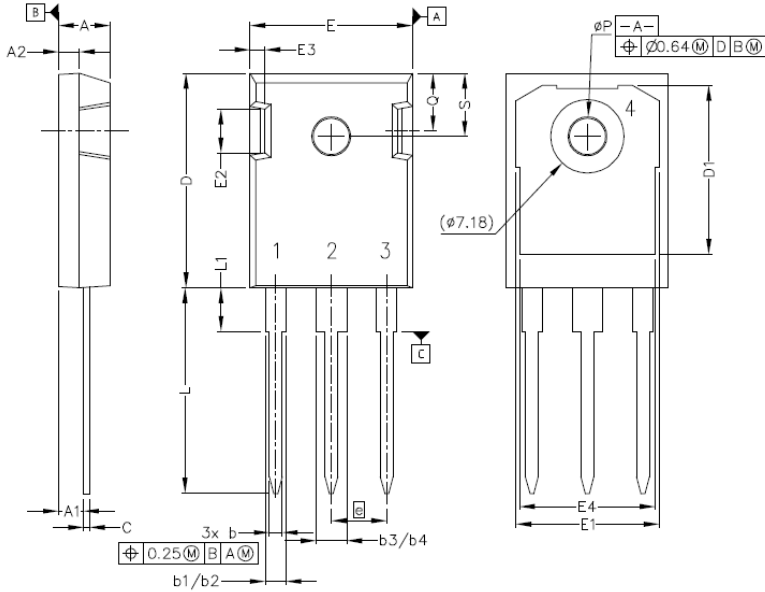

#### Pinout Information:

- Pin 1 = Gate
- Pin 2, 4 = Drain
- Pin 3 = Source

POS	Inches		Millimeters	
	Min	Max	Min	Max
A	.190	.205	4.83	5.21
A1	.090	.100	2.29	2.54
A2	.075	.085	1.91	2.16
b	.042	.052	1.07	1.33
b1	.075	.095	1.91	2.41
b2	.075	.085	1.91	2.16
b3	.113	.133	2.87	3.38
b4	.113	.123	2.87	3.13
c	.022	.027	0.55	0.68
D	.819	.831	20.80	21.10
D1	.640	.695	16.25	17.65
D2	.037	.049	0.95	1.25
E	.620	.635	15.75	16.13
E1	.516	.557	13.10	14.15
E2	.145	.201	3.68	5.10
E3	.039	.075	1.00	1.90
E4	.487	.529	12.38	13.43
e	.214 BSC		5.44 BSC	
N	3		3	
L	.780	.800	19.81	20.32
L1	.161	.173	4.10	4.40
ØP	.138	.144	3.51	3.65
Q	.216	.236	5.49	6.00
S	.238	.248	6.04	6.30
T	9°	11°	9°	11°
U	9°	11°	9°	11°
V	2°	8°	2°	8°
W	2°	8°	2°	8°

#### Recommended Solder Pad Layout

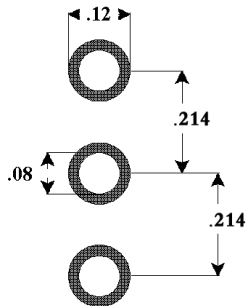

T0247-3L



### **Attention**

- Any and all HUA XUAN YANG ELECTRONICS products described or contained herein do not have specifications that can handle applications that require extremely high levels of reliability, such as life-support systems, aircraft's control systems, or other applications whose failure can be reasonably expected to result in serious physical and/or material damage. Consult with your HUA XUAN YANG ELECTRONICS representative nearest you before using any HUA XUAN YANG ELECTRONICS products described or contained herein in such applications.
- HUA XUAN YANG ELECTRONICS assumes no responsibility for equipment failures that result from using products at values that exceed, even momentarily, rated values (such as maximum ratings, operating condition ranges, or other parameters) listed in products specifications of any and all HUA XUAN YANG ELECTRONICS products described or contained herein.
- Specifications of any and all HUA XUAN YANG ELECTRONICS products described or contained herein stipulate the performance, characteristics, and functions of the described products in the independent state, and are not guarantees of the performance, characteristics, and functions of the described products as mounted in the customer's products or equipment. To verify symptoms and states that cannot be evaluated in an independent device, the customer should always evaluate and test devices mounted in the customer's products or equipment.
- HUA XUAN YANG ELECTRONICS CO.,LTD. strives to supply high-quality high-reliability products. However, any and all semiconductor products fail with some probability. It is possible that these probabilistic failures could give rise to accidents or events that could endanger human lives, that could give rise to smoke or fire, or that could cause damage to other property. When designing equipment, adopt safety measures so that these kinds of accidents or events cannot occur. Such measures include but are not limited to protective circuits and error prevention circuits for safe design, redundant design, and structural design.
- In the event that any or all HUA XUAN YANG ELECTRONICS products(including technical data, services) described or contained herein are controlled under any of applicable local export control laws and regulations, such products must not be exported without obtaining the export license from the authorities concerned in accordance with the above law.
- No part of this publication may be reproduced or transmitted in any form or by any means, electronic or mechanical, including photocopying and recording, or any information storage or retrieval system, or otherwise, without the prior written permission of HUA XUAN YANG ELECTRONICS CO.,LTD.
- Information (including circuit diagrams and circuit parameters) herein is for example only ; it is not guaranteed for volume production. HUA XUAN YANG ELECTRONICS believes information herein is accurate and reliable, but no guarantees are made or implied regarding its use or any infringements of intellectual property rights or other rights of third parties.
- Any and all information described or contained herein are subject to change without notice due to product/technology improvement, etc. When designing equipment, refer to the "Delivery Specification" for the HUA XUAN YANG ELECTRONICS product that you intend to use.