



### Features

- High Blocking Voltage with Low On-Resistance
- High Speed Switching with Low Capacitances
- Easy to Parallel and Simple to Drive
- Resistant to Latch-Up
- Halogen Free, RoHS Compliant

### Benefits

- Higher System Efficiency
- Reduced Cooling Requirements
- Increased Power Density
- Increased System Switching Frequency

### Applications

- Solar Inverters
- Switch Mode Power Supplies
- High Voltage DC/DC converters
- Battery Chargers
- Motor Drives
- Pulsed Power Applications

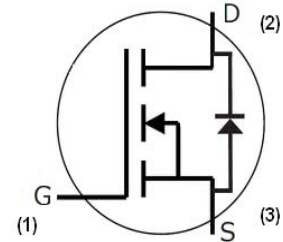
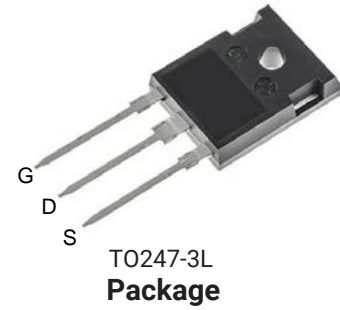

Part Number	Package	Marking
HC2M0160120D	TO247-3L	HC2M0160120D

### Maximum Ratings (T<sub>c</sub> = 25 °C unless otherwise specified)

Symbol	Parameter	Value	Unit	Test Conditions	Note
V <sub>DSmax</sub>	Drain - Source Voltage	1200	V	V <sub>GS</sub> = 0 V, I <sub>D</sub> = 100 μA	
V <sub>GSmax</sub>	Gate - Source Voltage	-10/+25	V	Absolute maximum values	
V <sub>GSop</sub>	Gate - Source Voltage	-5/+20	V	Recommended operational values	
I <sub>D</sub>	Continuous Drain Current	18	A	V <sub>GS</sub> = 20 V, T <sub>C</sub> = 25 °C	Fig. 19
		12		V <sub>GS</sub> = 20 V, T <sub>C</sub> = 100 °C	
I <sub>D(pulse)</sub>	Pulsed Drain Current	40	A	Pulse width t <sub>p</sub> limited by T <sub>Jmax</sub>	Fig. 22
P <sub>D</sub>	Power Dissipation	125	W	T <sub>C</sub> =25 °C, T <sub>J</sub> = 150 °C	Fig. 20
T <sub>J</sub> , T <sub>stg</sub>	Operating Junction and Storage Temperature	-55 to +150	°C		
T <sub>L</sub>	Solder Temperature	260	°C	1.6mm (0.063") from case for 10s	
M <sub>d</sub>	Mounting Torque	1 8.8	Nm lbf-in	M3 or 6-32 screw	



**Electrical Characteristics** ( $T_c = 25^\circ\text{C}$  unless otherwise specified)

Symbol	Parameter	Min.	Typ.	Max.	Unit	Test Conditions	Note
$V_{(BR)DSS}$	Drain-Source Breakdown Voltage	1200			V	$V_{GS} = 0\text{ V}, I_D = 100\ \mu\text{A}$	
$V_{GS(th)}$	Gate Threshold Voltage	2.0	2.9	4	V	$V_{DS} = V_{GS}, I_{DS} = 2.5\ \text{mA}$	Fig. 11
			2.4		V	$V_{DS} = V_{GS}, I_{DS} = 2.5\ \text{mA}, T_J = 150^\circ\text{C}$	
$I_{DSS}$	Zero Gate Voltage Drain Current		1	100	$\mu\text{A}$	$V_{DS} = 1200\ \text{V}, V_{GS} = 0\ \text{V}$	
$I_{GSS}$	Gate-Source Leakage Current			250	nA	$V_{GS} = 20\ \text{V}, V_{DS} = 0\ \text{V}$	
$R_{D(on)}$	Drain-Source On-State Resistance		160	196	m $\Omega$	$V_{GS} = 20\ \text{V}, I_D = 10\ \text{A}$	Fig. 4, 5, 6
			290			$V_{GS} = 20\ \text{V}, I_D = 10\ \text{A}, T_J = 150^\circ\text{C}$	
$g_{fs}$	Transconductance		3.8		S	$V_{DS} = 20\ \text{V}, I_{DS} = 10\ \text{A}$	Fig. 7
			5.3			$V_{DS} = 20\ \text{V}, I_{DS} = 10\ \text{A}, T_J = 150^\circ\text{C}$	
$C_{iss}$	Input Capacitance		606		pF	$V_{GS} = 0\ \text{V}$ $V_{DS} = 1000\ \text{V}$ $f = 1\ \text{MHz}$ $V_{AC} = 25\ \text{mV}$	Fig. 17, 18
$C_{oss}$	Output Capacitance		55				
$C_{rss}$	Reverse Transfer Capacitance		5				
$E_{oss}$	$C_{oss}$ Stored Energy		28				$\mu\text{J}$
$E_{AS}$	Avalanche Energy, Single Pulse		600		mJ	$I_D = 10\ \text{A}, V_{DD} = 50\ \text{V}$	Fig. 29
$E_{ON}$	Turn-On Switching Energy		121		$\mu\text{J}$	$V_{DS} = 800\ \text{V}, V_{GS} = -5/20\ \text{V}, I_D = 10\ \text{A}, R_{G(ext)} = 2.5\ \Omega, L = 434\ \mu\text{H}$	Fig. 25
$E_{OFF}$	Turn Off Switching Energy		48				
$t_{d(on)}$	Turn-On Delay Time		7		ns	$V_{DD} = 800\ \text{V}, V_{GS} = -5/20\ \text{V}$ $I_D = 10\ \text{A}$ $R_{G(ext)} = 2.5\ \Omega, R_L = 80\ \Omega$ Timing relative to $V_{DS}$ Per IEC60747-8-4 pg 83	Fig. 27
$t_r$	Rise Time		9				
$t_{d(off)}$	Turn-Off Delay Time		13				
$t_f$	Fall Time		14				
$R_{G(int)}$	Internal Gate Resistance		6.5		$\Omega$	$f = 1\ \text{MHz}, V_{AC} = 25\ \text{mV}$	
$Q_{gs}$	Gate to Source Charge		11		nC	$V_{DS} = 800\ \text{V}, V_{GS} = -5/20\ \text{V}$ $I_D = 10\ \text{A}$ Per IEC60747-8-4 pg 21	Fig. 12
$Q_{gd}$	Gate to Drain Charge		17				
$Q_g$	Total Gate Charge		40				

**Reverse Diode Characteristics**

Symbol	Parameter	Typ.	Max.	Unit	Test Conditions	Note
$V_{SD}$	Diode Forward Voltage	3.9		V	$V_{GS} = -5\ \text{V}, I_F = 5\ \text{A}$	Fig. 8, 9, 10
		3.5			$V_{GS} = -5\ \text{V}, I_F = 5\ \text{A}, T_J = 150^\circ\text{C}$	
$I_S$	Continuous Diode Forward Current		25	A	$T_C = 25^\circ\text{C}$	Note 1
$t_{rr}$	Reverse Recovery Time	20		ns	$V_{GS} = -5\ \text{V}, I_{SD} = 10\ \text{A}, V_R = 800\ \text{V}$ $dif/dt = 2400\ \text{A}/\mu\text{s}$	Note 1
$Q_{rr}$	Reverse Recovery Charge	192		nC		
$I_{rrm}$	Peak Reverse Recovery Current	16		A		

Note (1): When using SiC Body Diode the maximum recommended  $V_{GS} = -5\text{V}$

**Thermal Characteristics**

Symbol	Parameter	Typ.	Max.	Unit	Test Conditions	Note
$R_{\theta JC}$	Thermal Resistance from Junction to Case	0.9	1.0	K/W		Fig. 21
$R_{\theta JA}$	Thermal Resistance From Junction to Ambient		40			



Typical Performance

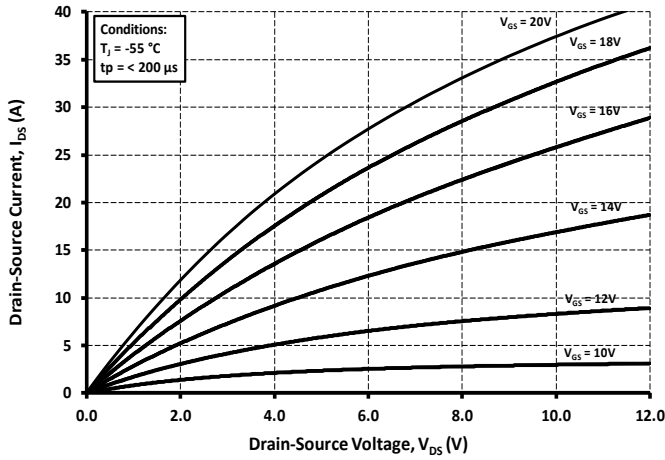

Figure 1. Output Characteristics  $T_J = -55\text{ }^\circ\text{C}$

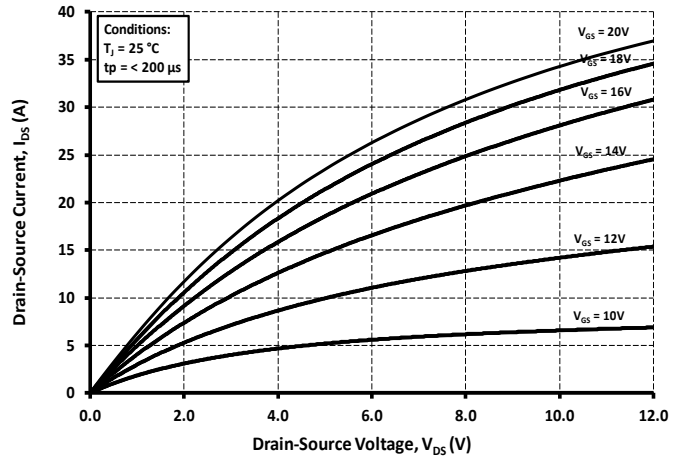

Figure 2. Output Characteristics  $T_J = 25\text{ }^\circ\text{C}$

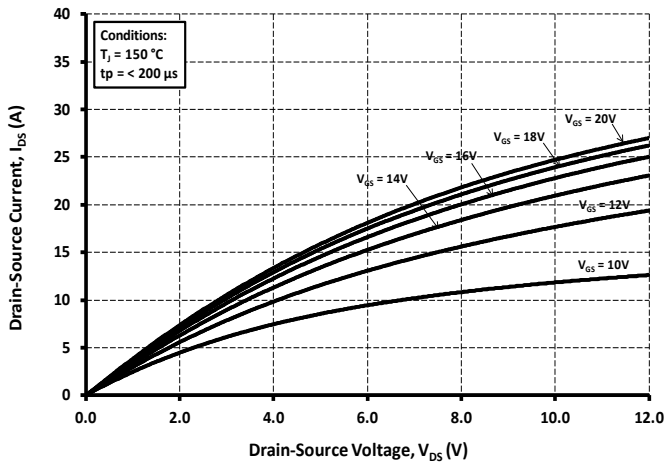

Figure 3. Output Characteristics  $T_J = 150\text{ }^\circ\text{C}$

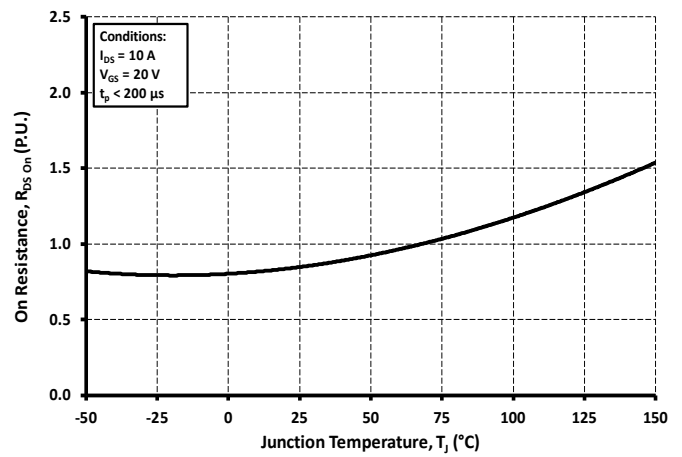

Figure 4. Normalized On-Resistance vs. Temperature

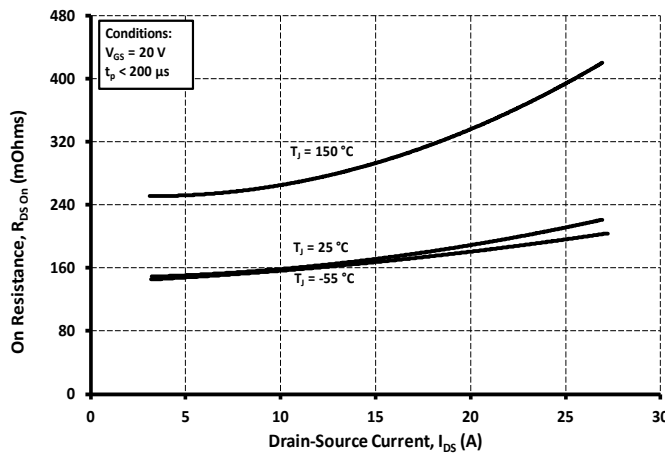

Figure 5. On-Resistance vs. Drain Current For Various Temperatures

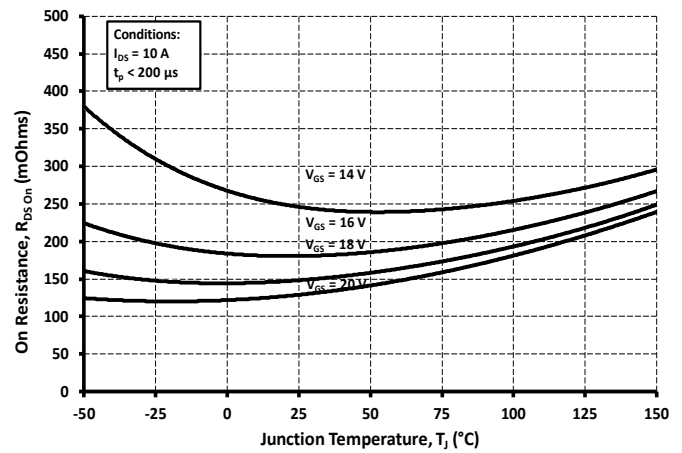

Figure 6. On-Resistance vs. Temperature For Various Gate Voltage



### Typical Performance

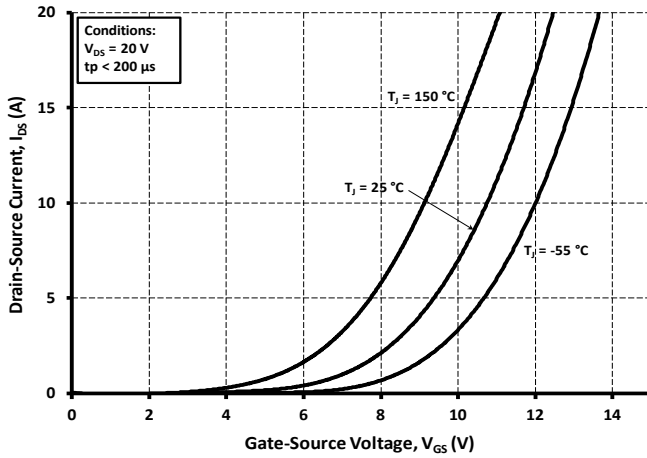

Figure 7. Transfer Characteristic for Various Junction Temperatures

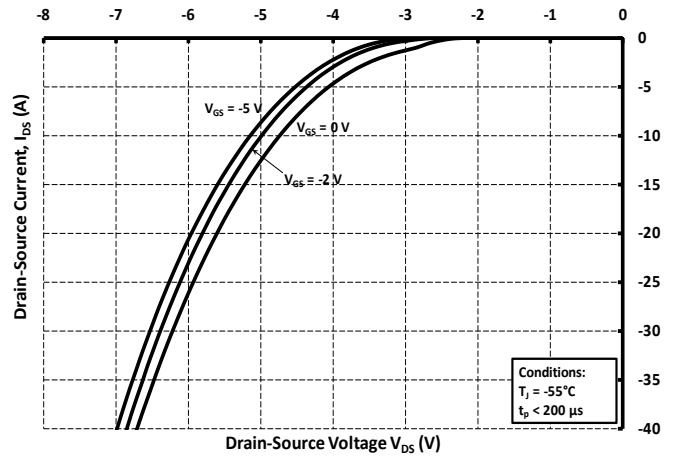

Figure 8. Body Diode Characteristic at  $-55^\circ\text{C}$

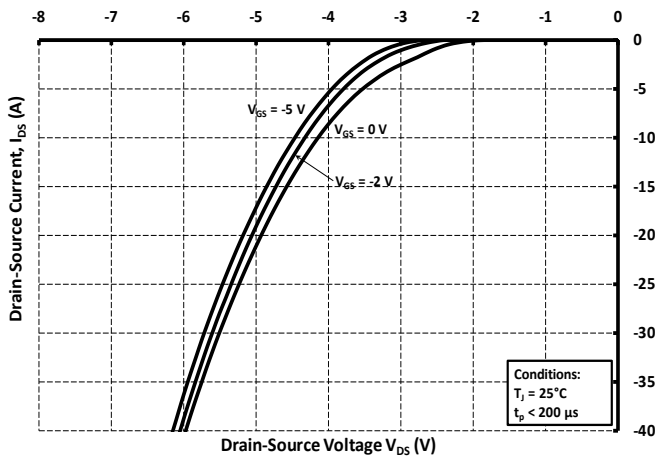

Figure 9. Body Diode Characteristic at  $25^\circ\text{C}$

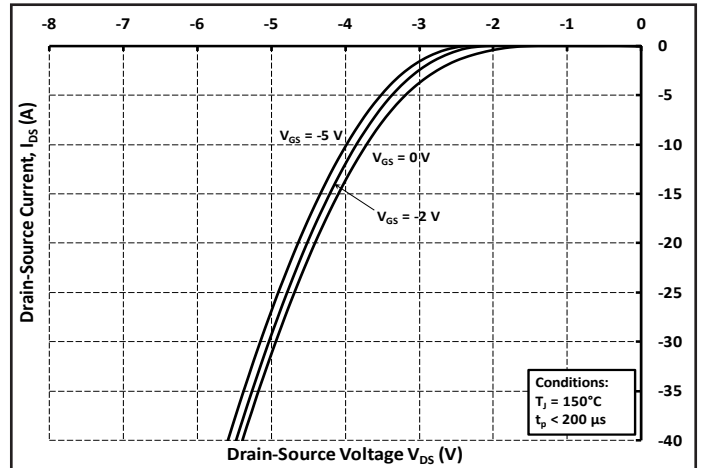

Figure 10. Body Diode Characteristic at  $150^\circ\text{C}$

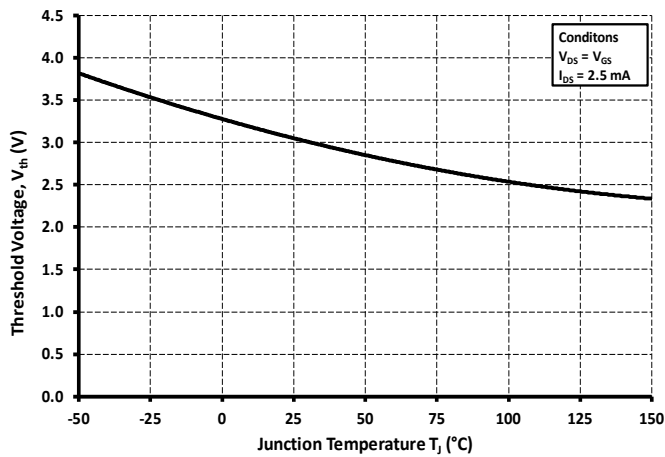

Figure 11. Threshold Voltage vs. Temperature

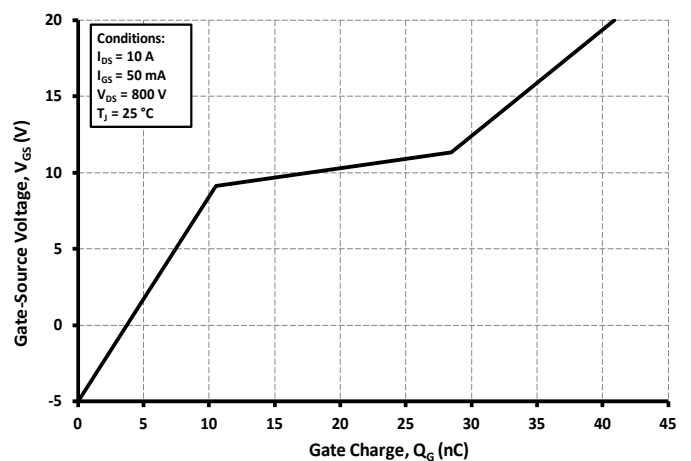

Figure 12. Gate Charge Characteristics



Typical Performance

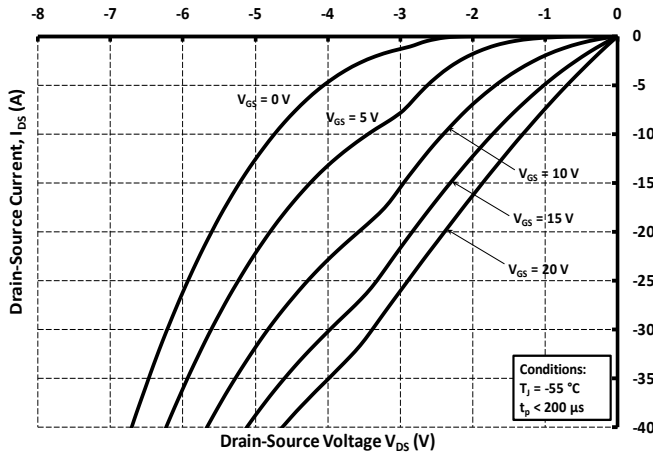

Figure 13. 3rd Quadrant Characteristic at  $-55\text{ }^\circ\text{C}$

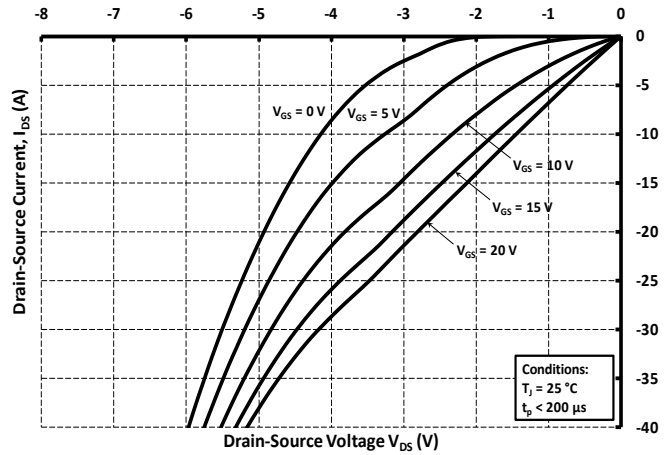

Figure 14. 3rd Quadrant Characteristic at  $25\text{ }^\circ\text{C}$

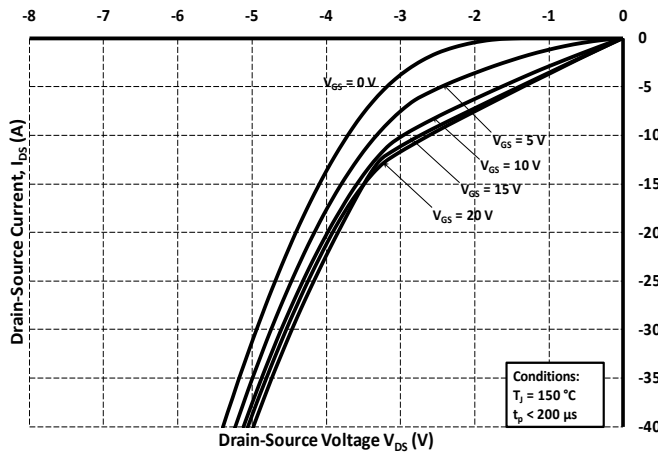

Figure 15. 3rd Quadrant Characteristic at  $150\text{ }^\circ\text{C}$

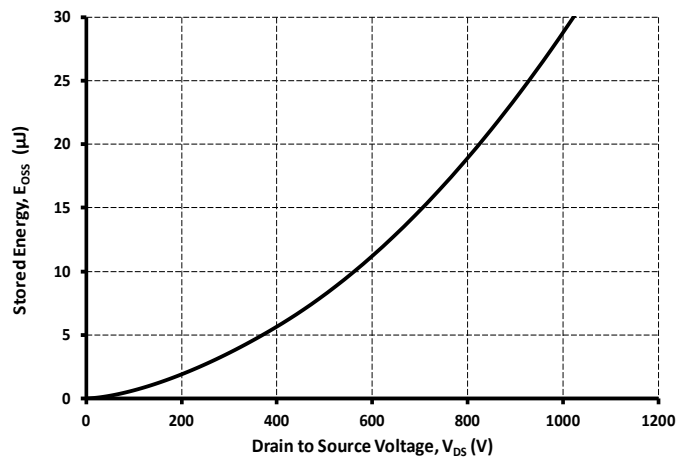

Figure 16. Output Capacitor Stored Energy

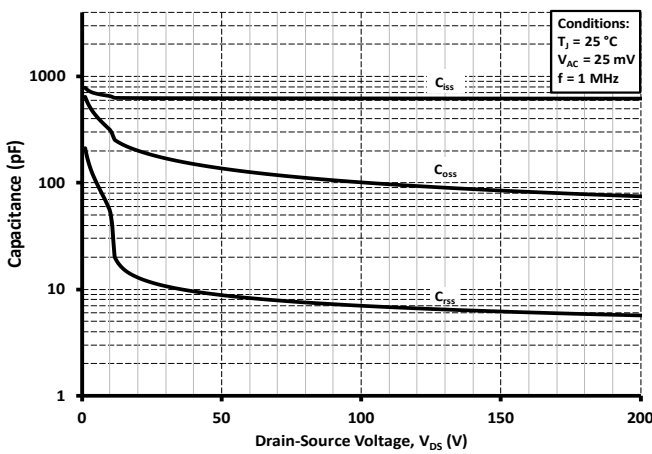

Figure 17. Capacitances vs. Drain-Source Voltage (0 - 200V)

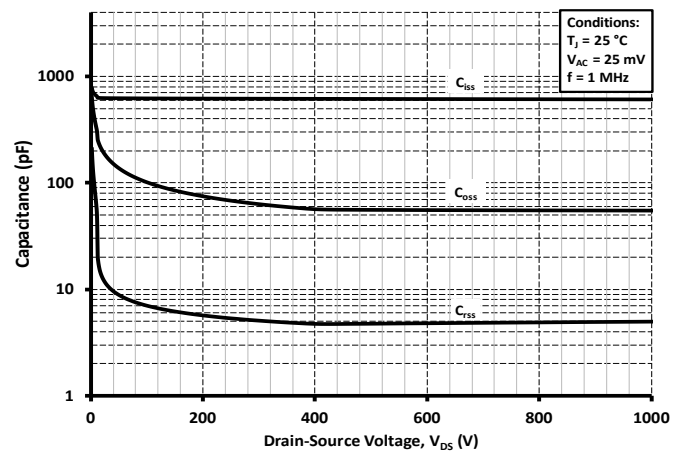

Figure 18. Capacitances vs. Drain-Source Voltage (0 - 1000V)



Typical Performance

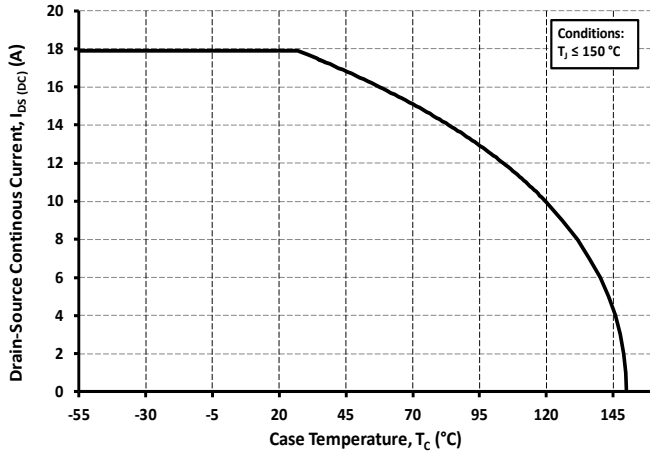

Figure 19. Continuous Drain Current Derating vs. Case Temperature

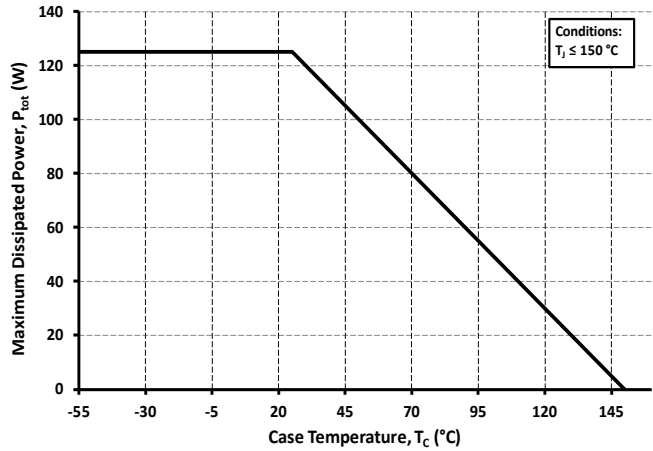

Figure 20. Maximum Power Dissipation Derating vs. Case Temperature

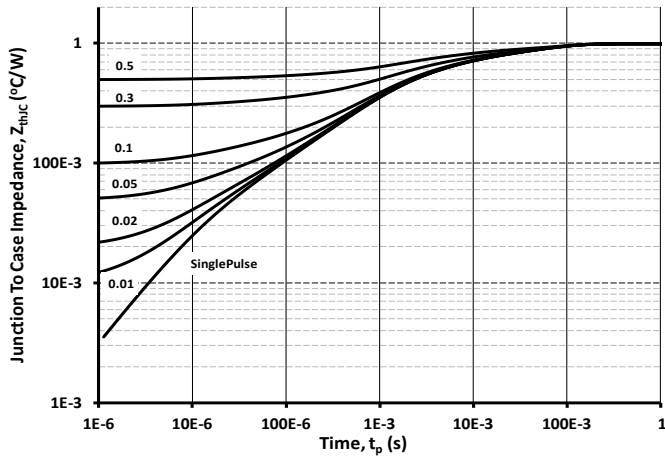

Figure 21. Transient Thermal Impedance (Junction - Case)

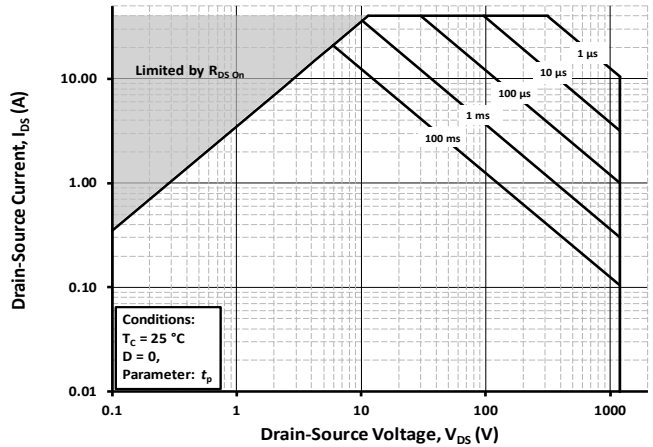

Figure 22. Safe Operating Area

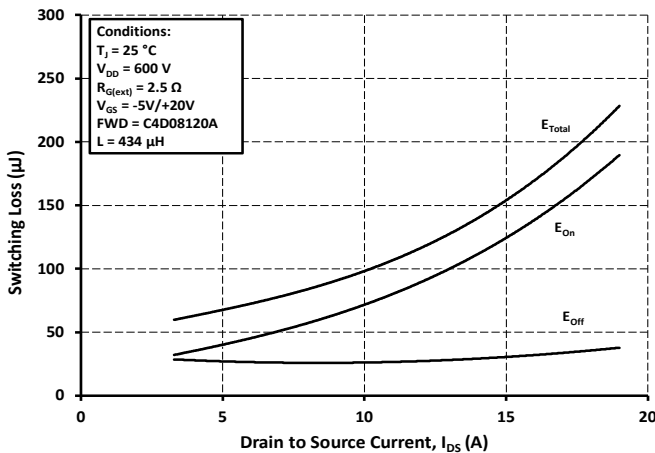

Figure 23. Clamped Inductive Switching Energy vs. Drain Current ( $V_{DS} = 600\text{ V}$ )

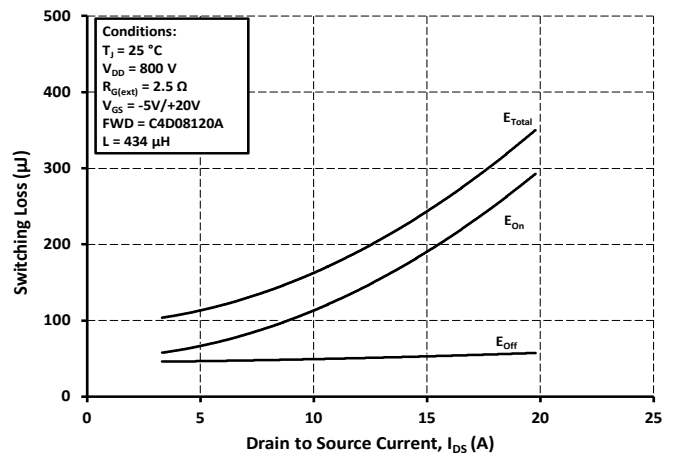

Figure 24. Clamped Inductive Switching Energy vs. Drain Current ( $V_{DS} = 800\text{ V}$ )



Typical Performance

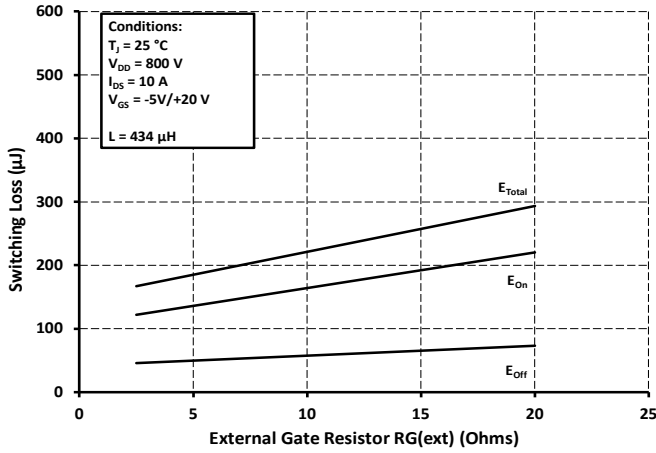

Figure 25. Clamped Inductive Switching Energy vs.  $R_{G(ext)}$

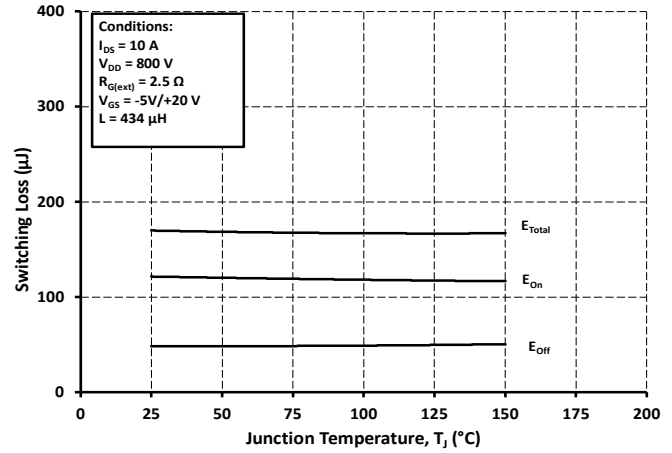

Figure 26. Clamped Inductive Switching Energy vs. Temperature

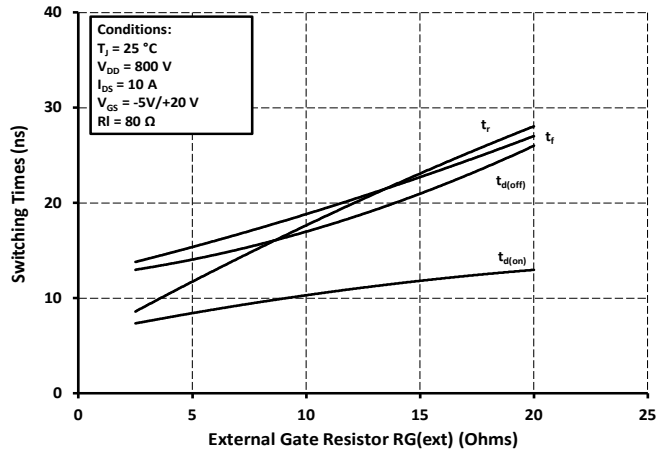

Figure 27. Switching Times vs.  $R_{G(ext)}$

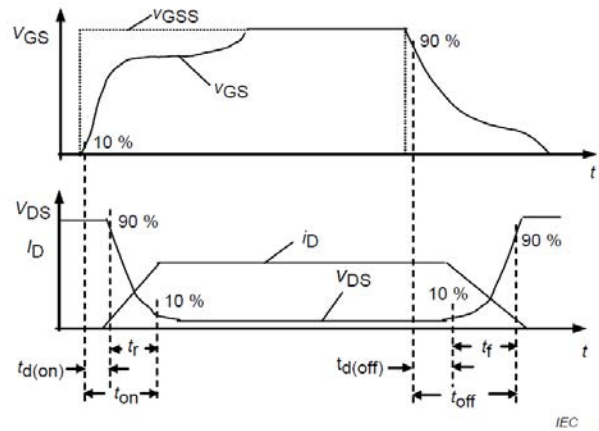

Figure 28. Switching Times Definition

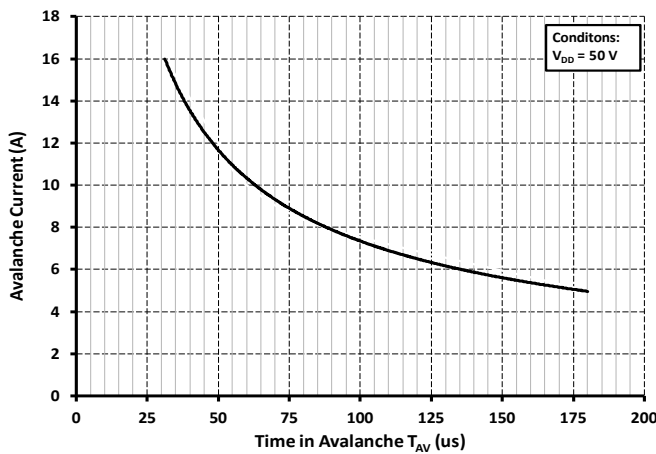

Figure 29. Single Avalanche SOA curve



### Test Circuit Schematic

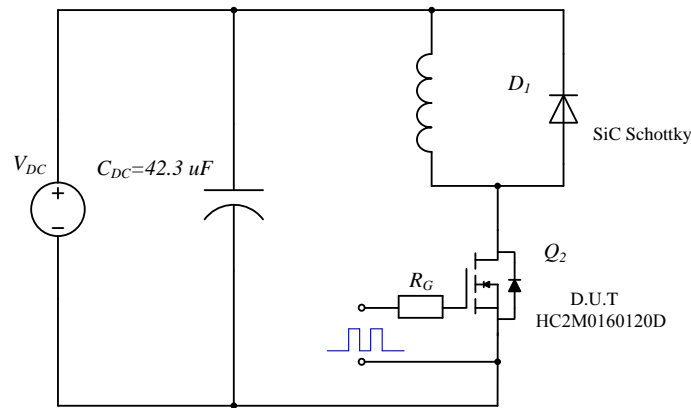

Figure 30. Clamped Inductive Switching  
Waveform Test Circuit

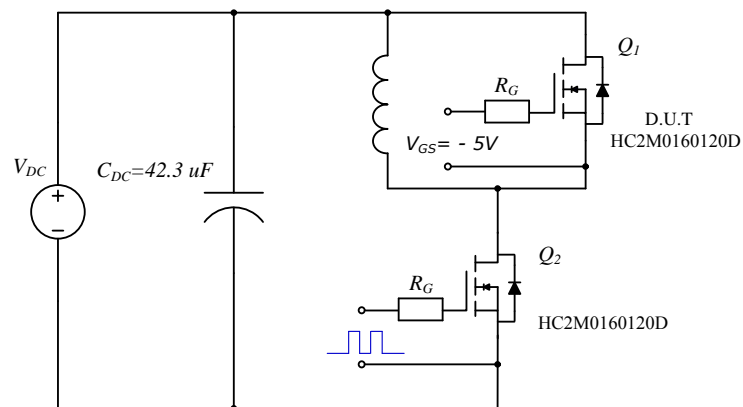

Figure 31. Body Diode Recovery Test Circuit

### ESD Ratings

ESD Test	Total Devices Sampled	Resulting Classification
ESD-HBM	All Devices Passed 1000V	2 (>2000V)
ESD-MM	All Devices Passed 400V	C (>400V)
ESD-CDM	All Devices Passed 1000V	IV (>1000V)





### Package Dimensions

Package T0247-3L

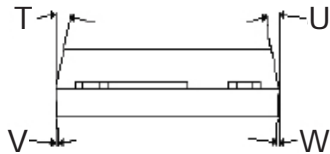
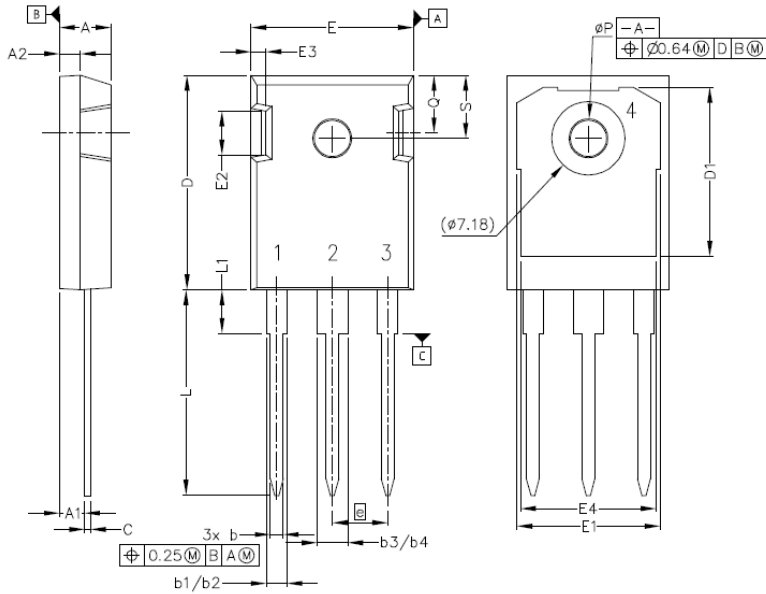

Pinout Information:

- Pin 1 = Gate
- Pin 2, 4 = Drain
- Pin 3 = Source

POS	Inches		Millimeters	
	Min	Max	Min	Max
A	.190	.205	4.83	5.21
A1	.090	.100	2.29	2.54
A2	.075	.085	1.91	2.16
b	.042	.052	1.07	1.33
b1	.075	.095	1.91	2.41
b2	.075	.085	1.91	2.16
b3	.113	.133	2.87	3.38
b4	.113	.123	2.87	3.13
c	.022	.027	0.55	0.68
D	.819	.831	20.80	21.10
D1	.640	.695	16.25	17.65
D2	.037	.049	0.95	1.25
E	.620	.635	15.75	16.13
E1	.516	.557	13.10	14.15
E2	.145	.201	3.68	5.10
E3	.039	.075	1.00	1.90
E4	.487	.529	12.38	13.43
e	.214 BSC		5.44 BSC	
N	3		3	
L	.780	.800	19.81	20.32
L1	.161	.173	4.10	4.40
ØP	.138	.144	3.51	3.65
Q	.216	.236	5.49	6.00
S	.238	.248	6.04	6.30
T	9°	11°	9°	11°
U	9°	11°	9°	11°
V	2°	8°	2°	8°
W	2°	8°	2°	8°

### Recommended Solder Pad Layout

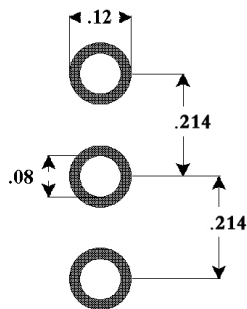

T0247-3L



### **Attention**

- Any and all HUA XUAN YANG ELECTRONICS products described or contained herein do not have specifications that can handle applications that require extremely high levels of reliability, such as life-support systems, aircraft's control systems, or other applications whose failure can be reasonably expected to result in serious physical and/or material damage. Consult with your HUA XUAN YANG ELECTRONICS representative nearest you before using any HUA XUAN YANG ELECTRONICS products described or contained herein in such applications.
  
- HUA XUAN YANG ELECTRONICS assumes no responsibility for equipment failures that result from using products at values that exceed, even momentarily, rated values (such as maximum ratings, operating condition ranges, or other parameters) listed in products specifications of any and all HUA XUAN YANG ELECTRONICS products described or contained herein.
  
- Specifications of any and all HUA XUAN YANG ELECTRONICS products described or contained herein stipulate the performance, characteristics, and functions of the described products in the independent state, and are not guarantees of the performance, characteristics, and functions of the described products as mounted in the customer's products or equipment. To verify symptoms and states that cannot be evaluated in an independent device, the customer should always evaluate and test devices mounted in the customer's products or equipment.
  
- HUA XUAN YANG ELECTRONICS CO.,LTD. strives to supply high-quality high-reliability products. However, any and all semiconductor products fail with some probability. It is possible that these probabilistic failures could give rise to accidents or events that could endanger human lives, that could give rise to smoke or fire, or that could cause damage to other property. When designing equipment, adopt safety measures so that these kinds of accidents or events cannot occur. Such measures include but are not limited to protective circuits and error prevention circuits for safe design, redundant design, and structural design.
  
- In the event that any or all HUA XUAN YANG ELECTRONICS products(including technical data, services) described or contained herein are controlled under any of applicable local export control laws and regulations, such products must not be exported without obtaining the export license from the authorities concerned in accordance with the above law.
  
- No part of this publication may be reproduced or transmitted in any form or by any means, electronic or mechanical, including photocopying and recording, or any information storage or retrieval system, or otherwise, without the prior written permission of HUA XUAN YANG ELECTRONICS CO.,LTD.
  
- Information (including circuit diagrams and circuit parameters) herein is for example only ; it is not guaranteed for volume production. HUA XUAN YANG ELECTRONICS believes information herein is accurate and reliable, but no guarantees are made or implied regarding its use or any infringements of intellectual property rights or other rights of third parties.
  
- Any and all information described or contained herein are subject to change without notice due to product/technology improvement, etc. When designing equipment, refer to the "Delivery Specification" for the HUA XUAN YANG ELECTRONICS product that you intend to use.