

STANDARD SPECIFICATION

产品规格书

客户 Customer : _____

客户料号 Customer P/N NO. : _____

产品描述 Product Description : 5032-2P 32.000MHZ 20PF ±10PPM

H X - C 料号 P/N. NO. : 5G032000CP

客户批准 Customer Approval :

审 核	批 准
Checked	APPROVED

(请批准后回签一份 PLEASE RETURN A COPY WITH APPROVAL)

拟 制 DESIGNER	审 核 CHECK	批 准 APPROVED
万力阳	蔡勤	柯建平

地址：深圳市龙华区龙胜路融创智汇大厦C座1401-1402室

Office add: Room 1401-1402, Building C, Rongchuang, Longhua District, shenzhen

TEL: 0755-21044642

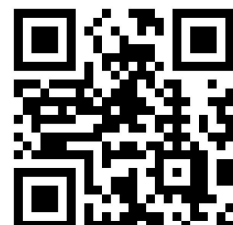

1. 石英晶体参数规格 QUARTZ CRYSTAL UNIT SPECIFICATION

描述 Description : Quartz Crystal
 产品型别 Product Type : 5032-2P
 测量设备 Measure equipment : S&A 250B
 电气特性 Electrical Characteristics

	项目 Item	符号 Symbol	电气特性规格 Electrical Specification				备注 Notes
			下限 Min.	中心 Typ.	上限 Max.	单位 Units	
1	标准频率 Nominal Frequency	FL	32.000			MHz	
2	震荡模式 Oscillation Mode	-	Fundamental			-	AT-CUT
3	负载电容 Load Capacitance	CL	20			pF	
4	频率偏差 Frequency Tolerance	-	-10	-	10	ppm	At 25°C±°C
5	温度频差 Equivalent Series Resistance		-30	-	30	ppm	
6	工作温度 Operating Temperature	TC	-40	-	85	°C	
7	激励功率 Drive Level	DL			400	μW	
8	谐振电阻 Resonant resistance	RR	≤60			Ω	
9	静电容 Direct capacitance	C0		≤3.0		pF	
10	绝缘电阻 Insulation resistance	IR		≥500		MΩ	At DC 100V
11	寄生衰减 Parasitic attenuation	SPDB		≤-3		dB	
12	老化率 Aging rate			±2		ppm	First year
13	储存温度范围 Storage temperature range	-	-55	-	+125	°C	

2. 外形尺寸 BOUNDARY DIMENSION

(单位: mm)

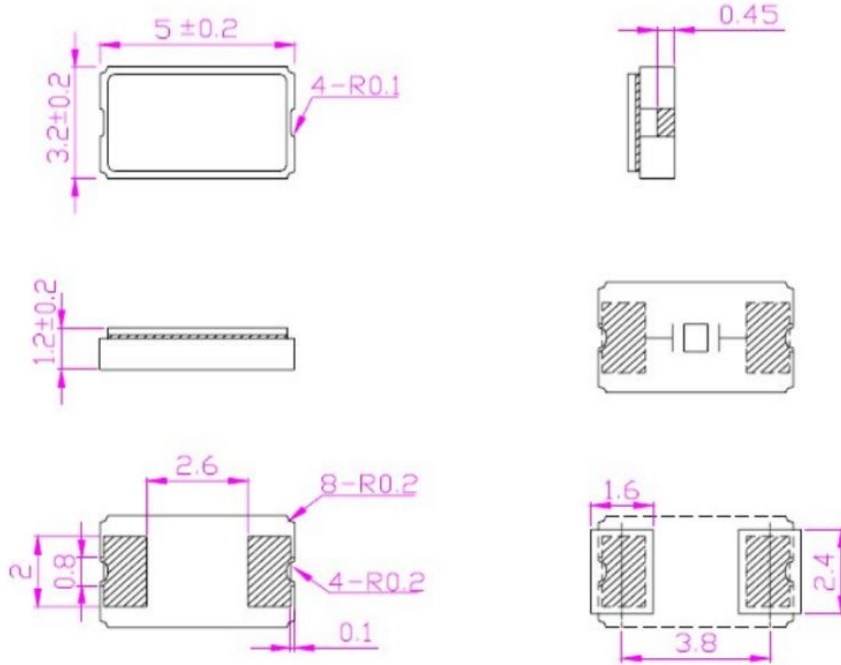

3. 印字

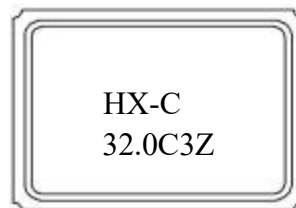

HX-C - - - - 华昕/HUAXIN

32.0 - - - - 频率

C - - - - 负载电容

3 - - - - 年份

Z - - - - 月份

4. 内部结构图 INSIDE STRUCTURE

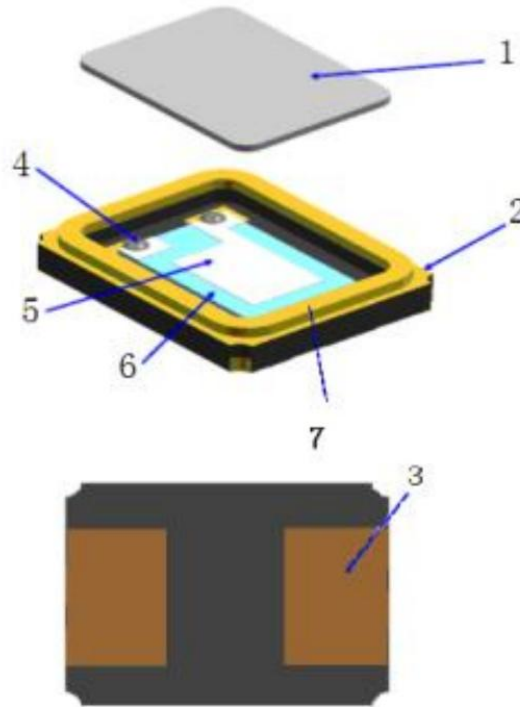

No.	组件 COMPONENTS	材料成份 MATERIALS
1	上盖 Loam cake	KOVAR
2	基座 Substrate	Al2O3
3	引脚 Pin	Au
4	导电胶 Conducting rein	Ag+硅树脂
5	电极 Electrode	Noble Metal
6	晶片 Crystal blank	SiO2
7	可伐环 Package	可伐合金

5. 编带包装 BRAID PACKAGING

(单位: mm)

1. 载带与编带盘尺寸

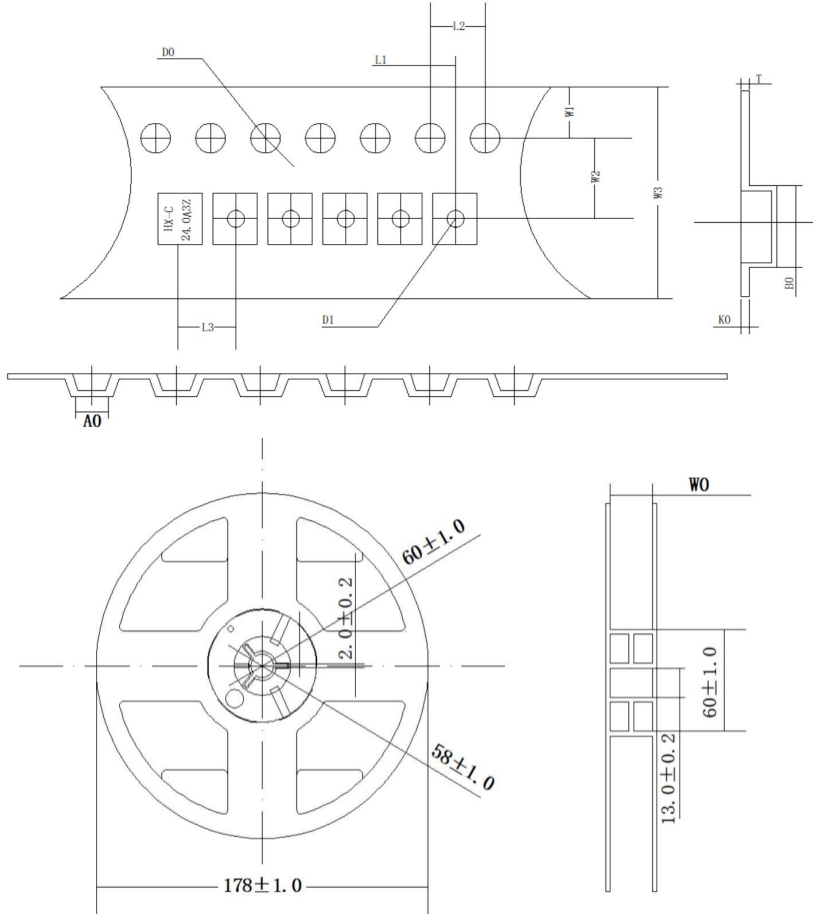

L1	2.00±0.1
L2	4.00±0.1
L3	4.00±0.1
D0	1.50±0.1
D1	1.00±0.1
W0	8.30±0.2
W1	1.75±0.1
W2	3.50±0.1
W3	8.00±0.1
A0	2.72±0.1
B0	3.46±0.1
K0	1.00±0.1
T	0.22±0.05

2. 剥离方式见下图, 强度: 20g-100g

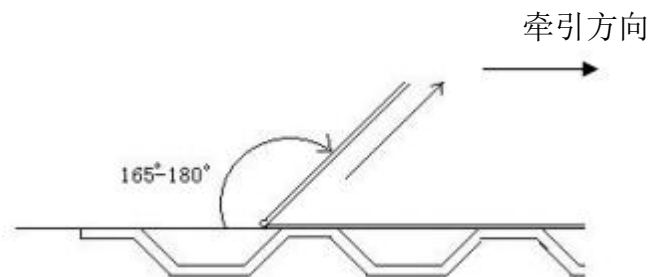

6. 可靠性试验 RELIABILITY SPECIFICATION

参考标准REFER		JIS C 6701	
NO.	项目 ITEM	测试条件 CONDITIONS	判定标准 Criteria
1	跌落 FREE FALL	从150cm位置高度,自由跌落在木板上,连续3次. FREE DROPPING FROM 150 cm HEIGHT 3 TIMES ON A HARD	A.C
2	振动 VIBRATION	振动频率: 10~2000 Hz, 振幅: 1.52mm, 时间: 每个方位三面(X、Y、Z)各振动2小时 FREQUENCY: 10.2000Hz;AMPLITUDE (TOTAL EXCURSION): 1.5mm SWEEP TIME: 2-3MIN, 3 DIRECTION(X, Y, Z) EACH FOR 2 Hrs.	A.C
3	温度冲击 TEMPERATURE SHOCK	晶体放入试验箱中, 高、低温循环10次 THE CRYSTAL UNIT SHALL BE SUBJECTED TO 10 SUCCESSIVE CHANGE OF TEMPERATURE CYCLE 	A.C.D
4	气密性 FINE LEAK	氦气压力标准: 5.0~5.5Kg/cm ² , 加压时间: 2 小时 HELIUM BOMBING 5.0~5.5 Kgf / cm ² ,FOR 2 HOURS.	D
5	可焊性 SOLDERABILITY	温度: 245±5°C, 浸锡时间: 3±0.5 秒 THE LEAD IS IMMERSIED IN A 245±5°C SOLDER BATH WITHIN 3±0.5 SECONDS.	E
6	稳态湿热 HIGH TEMP. & HUMIDITY	温度: 85±3°C, 湿度: 85%, 保持时间: 500个小时 STORED AT 85±3°C AND HUMIDITY 85% FOR 500±12H.	A.C.D
7	高温存储 HIGH TEMPERATURE STORAGE	高温温度: 125±2°C, 时间: 500±12 个小时 STORED AT 125±2°C FOR 500±12H. 如果客户的温度要求是高于标准,则必须根据客户的要求测试 If Customer's temperature request is higher than the standard, Temperature test must be done for customer requirements	A.C.D
8	低温存储 LOW TEMPERATURE STORAGE	低温温度: -40±2°C, 时间: 500±12 个小时 STORED AT -40±2°C FOR 500±12H. 如果客户的温度要求是低于标准,则必须根据客户的要求测试 If Customer's temperature request is lower than the standard, Temperature test must be done for customer requirements	A.C.D

7. 可靠性判定

规 格	
A	频率变化: $\pm 5\text{ppm}$ 以内或者满足客户规格要求。 Frequency variation: $\pm 5\text{ppm}$ or meet customer specifications.
B	频率变化: $\pm 10\text{ppm}$ 以内或者满足客户规格要求。 Frequency variation: $\pm 10\text{ppm}$ or meet customer specifications.
C	谐振电阻 (RR) 变化: $\pm 20\%$ 以内或者 $5\ \Omega$ 。(取较大值) Resonant resistance (RR) changes: $\pm 20\%$ or less than $5\ \Omega$ (take the larger value).
D	常温常湿状态下放置2小时后测试。规格要求。 Frequency variation: $\pm 10\text{ppm}$ or meet customer specifications.
E	侵入端至少95%面积覆盖着新的焊接材料。 At least 95% of the immersion end is covered with new welding material.

8. 回流焊温度曲线 REFLOW PROFILES



★ 备注:

1. 以上可靠性项目为我司常规测试项目, 若客户对产品有跌落, 冲击, 碰撞以及涉及到超声波焊接工艺的需求, 请将贵司的需求反馈给我司, 我司会对该产品的可靠性项目进行更新。 2. 客户端在对晶体加热后, 为了保证频率的准确性, 建议将晶体充分冷却后再进行相关测试。 3. 该产品符合公司环保标准要求。

1. The above reliability items are routine test items of our company. If the customer has requirements on the products including drop, impact, collision and ultrasonic wave welding process, please feedback your requirements to our company, and we will update the reliability items of this product. 2. In order to ensure the accuracy of frequency, it is recommended to fully cool the crystal after heating it on the client. 3. The product meets the company's environmental standards.