

The PT7706 is a high-performance 18-Amp Integrated Switching Regulator (ISR), housed in a 27-pin SIP package. The 18A capability allows easy integration of the latest high-speed, low-voltage μ Ps, DSPs, ASICs, and bus drivers into existing 3.3V systems.

The PT7706 series has been designed to work in parallel with one or more of the PT7749 - 18A current boosters for increased I_{out} in increments of 18A.

The output voltage of the PT7706 can be easily programmed with a 4 bit input compatible with Intel's Pentium[®] II Processor. A differential remote sense is also provided which automatically compensates for any voltage drop from the ISR to the load.

An input capacitance of 1200 μ F, and output capacitance of 330 μ F are required for proper operation.

Standard Application

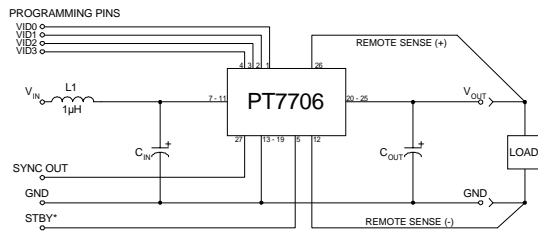

C_{in} = Required 1200 μ F electrolytic
 C_{out} = Required 330 μ F electrolytic
L1 = Optional 1 μ H input choke

Pin-Out Information

Pin Function	Pin Function	Pin Function
1 VID0	10 V_{in}	19 GND
2 VID1	11 V_{in}	20 V_{out}
3 VID2	12 Remote Sense Gnd	21 V_{out}
4 VID3	13 GND	22 V_{out}
5 STBY* - Stand-by	14 GND	23 V_{out}
6 Do not connect	15 GND	24 V_{out}
7 V_{in}	16 GND	25 V_{out}
8 V_{in}	17 GND	26 Remote Sense V_{out}
9 V_{in}	18 GND	27 Sync Out

For STBY* pin; open = output enabled
ground = output disabled.

Specifications

Characteristics ($T_a = 25^\circ\text{C}$ unless noted)	Symbols	Conditions	PT7706 SERIES			Units
			Min	Typ	Max	
Output Current	I_o	$T_a = +60^\circ\text{C}$, 200 LFM, pkg N $T_a = +25^\circ\text{C}$, natural convection	0.1 (1) 0.1 (1)	—	18 (2) 15 (2)	A
Input Voltage Range	V_{in}	$0.1\text{A} \leq I_o \leq 15\text{A}$	3.1 (3)	—	3.6	V
Output Voltage Tolerance	ΔV_o	$V_{in} = +3.3\text{V}$, $I_o = 18\text{A}$ $0^\circ\text{C} \leq T_a \leq +65^\circ\text{C}$	$V_o - 0.03$	—	$V_o + 0.03$	V
Line Regulation	Reg_{line}	$3.1\text{V} \leq V_{in} \leq 3.6\text{V}$, $I_o = 18\text{A}$	—	± 10	—	mV
Load Regulation	Reg_{load}	$V_{in} = +3.3\text{V}$, $0.1 \leq I_o \leq 18\text{A}$	—	± 10	—	mV
V_o Ripple/Noise	V_n	$V_{in} = +3.3\text{V}$, $I_o = 18\text{A}$	—	50	—	mV
Transient Response with $C_{out} = 330\mu\text{F}$	t_{tr} V_{os}	I_o step between 9A and 18A V_o over/undershoot	— —	100 200	— —	μSec mV
Efficiency	η	$V_{in} = +3.3\text{V}$, $I_o = 10\text{A}$	$V_o = 1.8\text{V}$ $V_o = 1.5\text{V}$	79 77	— —	% %
Switching Frequency	f_o	$3.1\text{V} \leq V_{in} \leq 3.6\text{V}$ $0.1\text{A} \leq I_o \leq 18\text{A}$	650	700	750	kHz
Absolute Maximum Operating Temperature Range	T_a	—	0	—	+85 (4)	$^\circ\text{C}$
Storage Temperature	T_s	—	-40	—	+125	$^\circ\text{C}$
Mechanical Shock		Per Mil-STD-883D, Method 2002.3 1 msec, Half Sine, mounted to a fixture	—	500	—	G's
Mechanical Vibration		Per Mil-STD-883D, Method 2007.2, 20-2000 Hz, Soldered in a PC board	—	10	—	G's
Weight	—	Vertical/Horizontal	—	31/41	—	grams

- Notes:** (1) The ISR will operate down to no load with reduced specifications. Please note that this product is not short-circuit protected.
(2) The PT7706 series can be easily paralleled with one or more of the PT7749 Current Boosters to provide increased output current in increments of 18A.
(3) The minimum input voltage is 3.1V or $V_{out} + 1.2\text{V}$, whichever is greater.
(4) See Safe Operating Area curves.

Output Capacitors: The PT7706 series requires a minimum output capacitance of 330 μ F for proper operation. Do not use Oscon type capacitors. The maximum allowable output capacitance is 15,000 μ F.

Input Filter: An input filter is optional for most applications. The input inductor must be sized to handle 18ADC with a typical value of 1 μ H. The input capacitance must be rated for a minimum of 1.3Arms of ripple current. For transient or dynamic load applications, additional capacitance may be required.

PT7706—3.3V

18 Amp “Big-Hammer” Programmable Integrated Switching Regulator

Features

- +3.3V input
- 4-bit Programmable: 1.3V to 2.05V@18A
- High Efficiency
- Input Voltage Range: 3.1V to 3.6V
- Differential Remote Sense
- 27-pin SIP Package
- Parallelable with PT7749 18A “Current Boosters”

Programming Information

VID3	VID2	VID1	VID0	Vout
1	1	1	1	1.30V
1	1	1	0	1.35V
1	1	0	1	1.40V
1	1	0	0	1.45V
1	0	1	1	1.50V
1	0	1	0	1.55V
1	0	0	1	1.60V
1	0	0	0	1.65V
0	1	1	1	1.70V
0	1	1	0	1.75V
0	1	0	1	1.80V
0	1	0	0	1.85V
0	0	1	1	1.90V
0	0	1	0	1.95V
0	0	0	1	2.00V

Logic 0 = Pin 12 potential (remote sense gnd)
 Logic 1 = Open circuit (no pull-up resistors)
 VID3 may not be changed while the unit is operating.

Ordering Information

PT7706□ = 1.3 to 2.05 Volts

(For dimensions and PC board layout, see Package Styles 800 and 810.)

PT Series Suffix (PT1234X)

Case/Pin Configuration

Vertical Through-Hole	N
Horizontal Through-Hole	A
Horizontal Surface Mount	C

TYPICAL CHARACTERISTICS

Safe Operating Area @V_{IN} = 3.3VDC (See Note B)

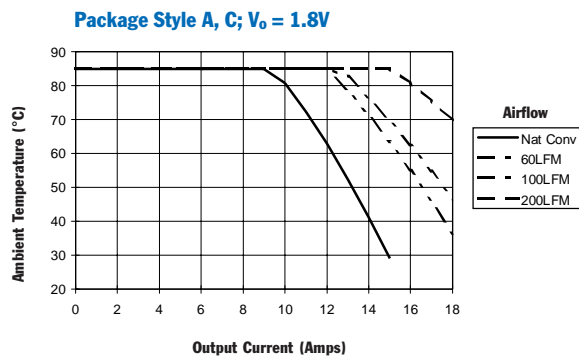
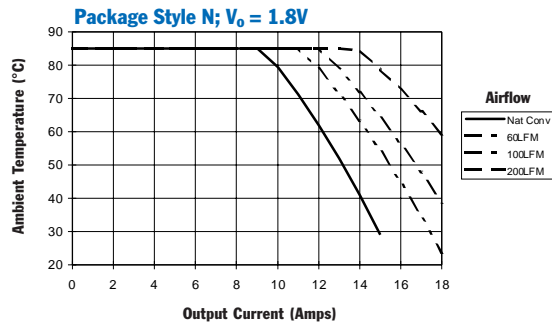

Characteristic Data @V_{IN} = 3.3VDC (See Note A)

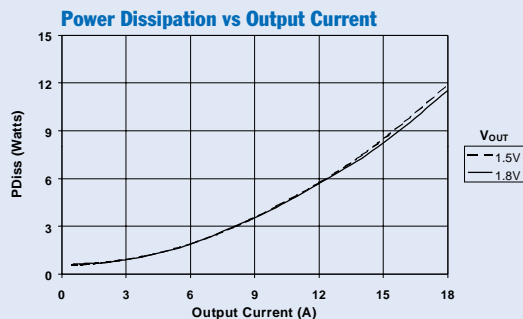
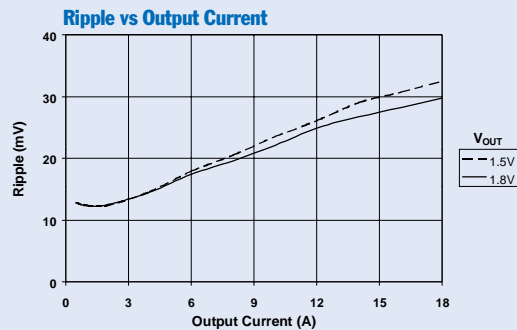
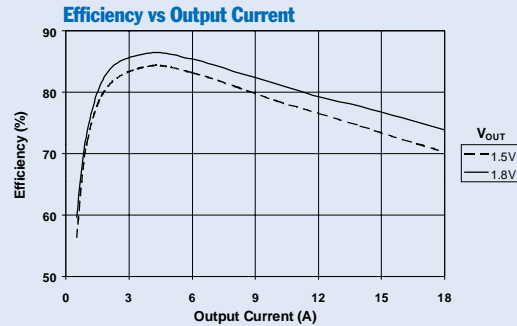

Note A: Characteristic data in the above graphs has been developed from actual products tested at 25°C. This data is considered typical data for the ISR.

Note B: SOA curves represent operating conditions at which internal components are at or above manufacturer's maximum rated operating temperatures.

Pin-Coded Output Voltage Adjustment on the “Big Hammer” Series ISRs

The ISRs related to Power Trends’ PT7705 incorporate pin-coded voltage control to adjust the output voltage. The control pins are identified VID0 - VID4 (pins 1, 2, 3, 4, & 6) respectively. When the control pins are left open-circuit, the ISR output will regulate at its factory trimmed output voltage. Each pin is internally connected to a precision resistor, which when grounded changes the output voltage by a set amount. By selectively grounding VID0 -VID4, the output voltage these ISRs can be programmed in incremental steps over the specified output voltage range. In each case, the program code and output voltage range offered by these ISRs are compatible with the voltage ID specification defined by Intel Corporation for voltage regulator modules (VRMs) used to power Pentium® microprocessors. Refer to Figure 1 below for the connection schematic, and the respective device Data Sheet for the appropriate programming code information.

Notes:

- The programming convention is as follows:-
 Logic 0: Connect to pin12 (Remote Sense Ground).
 Logic 1: Open circuit/open drain (See notes 2, & 4)
- Do not connect pull-up resistors to the voltage programming pins.
- To minimize output voltage error, always use pin 12 (Remote Sense Ground) as the logic “0” reference. While the regular ground (pins 13-19) can also be used for programming, doing so will degrade the load regulation of the product.

- If active devices are used to ground the voltage control pins, low-level open drain MOSFET devices should be used over bipolar transistors. The inherent $V_{ce(sat)}$ in bipolar devices introduces errors in the device’s internal divider network. Discrete transistors such as the BSS138, 2N7002, IRLML2402, or the 74C906 hex open-drain buffer are examples of appropriate devices.

Active Voltage Programming:

Special precautions should be taken when making changes to the voltage control program code while the unit is powered. It is highly recommended that the ISR be either powered down or held in standby. Changes made to the program code while V_{out} is enabled induces high current transients through the device. This is the result of the electrolytic output capacitors being either charged or discharged to the new output voltage set-point. The transient current can be minimized by making only incremental changes to the binary code, i.e. one LSB at a time. A minimum of 100µs settling time between each program state is also recommended. Making non-incremental changes to VID3 and VID4 with the output enabled is discouraged. If they are changed, the transients induced can overstress the device resulting in a permanent drop in efficiency. If the use of active devices prevents the program code being asserted prior to power-up, pull pin 5 (STBY) to the device GND during the period that the input voltage is applied to V_{in} . Releasing pin 5 will then allow the device output to execute a soft-start power-up to the programmed voltage.

Figure 1

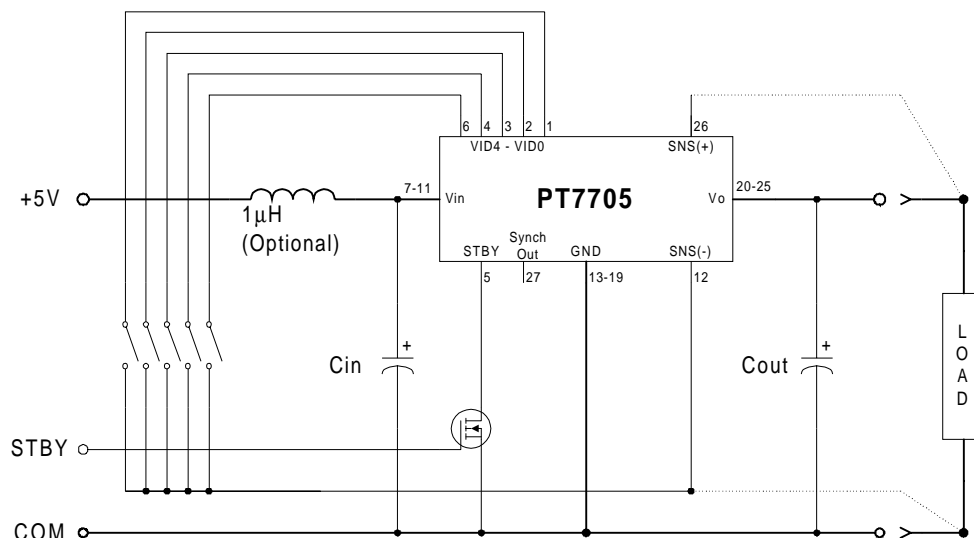

Using the Standby Function on the “Big Hammer” Programmable ISR Series

For applications requiring output voltage On/Off control, the PT7705 “Big Hammer” ISRs incorporate a standby function¹. This feature may be used for power-up/shutdown sequencing, and to change the output voltage while input power is applied. *See related notes:* “Pin-coded Output Voltage Adjustment on the ‘Big Hammer’ Series ISRs.”

The standby function is provided by the *STBY** control, pin 5. If pin 5 is left open-circuit the regulator operates normally, providing a regulated output whenever a valid supply voltage is applied to V_{in} (pins 7-11) with respect to GND (pins 13-19). Connecting pin 5 to ground² will set the regulator output to zero volts³. This places the regulator in standby mode, and reduces the input current to typically 45mA (75mA max). If a ground signal is applied to pin 5 prior to power-up, the regulator output will be held at zero volts during the period that input power is applied.

The standby input must be controlled with an open-collector (or open-drain) discrete transistor (See Figure 1). Table 1 gives the threshold requirements.

Table 1 Inhibit Control Threshold²

Parameter	Min	Max
Disable (V_{IL})	-0.1V	0.3V

Notes:

1. The Standby/Inhibit control logic is similar for all Power Trends’ modules, but the flexibility and threshold tolerances will be different. For specific information on this function for other regulator models, consult the applicable application note.
2. The Standby input on the PT7705 regulator series must be controlled using an open-collector (or open-drain) discrete transistor. *Do Not* use a pull-up resistor. The control input has an open-circuit voltage of about 1.5Vdc. To set the regulator output to zero, the control pin must be “pulled” to less than 0.3Vdc with a low-level 0.1mA sink to ground.
3. When placed in the standby mode, the regulator output discharges the output capacitance with a low impedance to ground. If an external voltage is applied to the output, it will sink current and possibly over-stress the part.
4. The turn-off time of Q_1 , or rise time of the standby input is not critical on the PT7705 series. Turning Q_1 off slowly, over periods up to 100ms, will not affect regulator operation. However, a slow turn-off time will increase both the initial delay and rise-time of the output voltage.

Figure 1

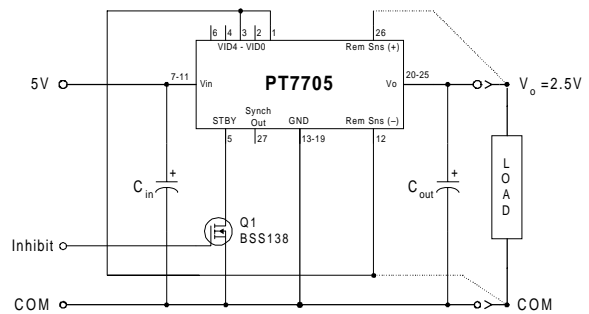

Turn-On Time: Turning Q_1 in Figure 1 off, removes the low-voltage signal at pin 5 and enables the output. Following a brief delay of 5-10ms, the output voltage of the PT7705 series regulators rise to full regulation within 15ms⁴. Figure 2 shows the typical output voltage waveform of a PT7705 following the prompt turn-off of Q_1 at time $t=0$ secs. The output voltage in Figure 1 is set to 2.5V by connecting VID0 (pin 1), and VID2 (pin 3) to the Remote Sense Gnd (pin 12)^{*}. The waveform in Figure 2 was measured with a 5V input source voltage, and 10A resistive load.

Figure 2

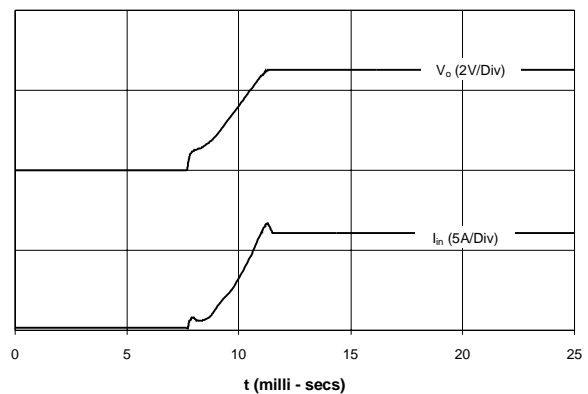

^{*} Consult the data sheet for details on other VID codes.

IMPORTANT NOTICE

Texas Instruments Incorporated and its subsidiaries (TI) reserve the right to make corrections, modifications, enhancements, improvements, and other changes to its products and services at any time and to discontinue any product or service without notice. Customers should obtain the latest relevant information before placing orders and should verify that such information is current and complete. All products are sold subject to TI's terms and conditions of sale supplied at the time of order acknowledgment.

TI warrants performance of its hardware products to the specifications applicable at the time of sale in accordance with TI's standard warranty. Testing and other quality control techniques are used to the extent TI deems necessary to support this warranty. Except where mandated by government requirements, testing of all parameters of each product is not necessarily performed.

TI assumes no liability for applications assistance or customer product design. Customers are responsible for their products and applications using TI components. To minimize the risks associated with customer products and applications, customers should provide adequate design and operating safeguards.

TI does not warrant or represent that any license, either express or implied, is granted under any TI patent right, copyright, mask work right, or other TI intellectual property right relating to any combination, machine, or process in which TI products or services are used. Information published by TI regarding third-party products or services does not constitute a license from TI to use such products or services or a warranty or endorsement thereof. Use of such information may require a license from a third party under the patents or other intellectual property of the third party, or a license from TI under the patents or other intellectual property of TI.

Reproduction of TI information in TI data books or data sheets is permissible only if reproduction is without alteration and is accompanied by all associated warranties, conditions, limitations, and notices. Reproduction of this information with alteration is an unfair and deceptive business practice. TI is not responsible or liable for such altered documentation. Information of third parties may be subject to additional restrictions.

Resale of TI products or services with statements different from or beyond the parameters stated by TI for that product or service voids all express and any implied warranties for the associated TI product or service and is an unfair and deceptive business practice. TI is not responsible or liable for any such statements.

TI products are not authorized for use in safety-critical applications (such as life support) where a failure of the TI product would reasonably be expected to cause severe personal injury or death, unless officers of the parties have executed an agreement specifically governing such use. Buyers represent that they have all necessary expertise in the safety and regulatory ramifications of their applications, and acknowledge and agree that they are solely responsible for all legal, regulatory and safety-related requirements concerning their products and any use of TI products in such safety-critical applications, notwithstanding any applications-related information or support that may be provided by TI. Further, Buyers must fully indemnify TI and its representatives against any damages arising out of the use of TI products in such safety-critical applications.

TI products are neither designed nor intended for use in military/aerospace applications or environments unless the TI products are specifically designated by TI as military-grade or "enhanced plastic." Only products designated by TI as military-grade meet military specifications. Buyers acknowledge and agree that any such use of TI products which TI has not designated as military-grade is solely at the Buyer's risk, and that they are solely responsible for compliance with all legal and regulatory requirements in connection with such use.

TI products are neither designed nor intended for use in automotive applications or environments unless the specific TI products are designated by TI as compliant with ISO/TS 16949 requirements. Buyers acknowledge and agree that, if they use any non-designated products in automotive applications, TI will not be responsible for any failure to meet such requirements.

Following are URLs where you can obtain information on other Texas Instruments products and application solutions:

Products		Applications	
Amplifiers	amplifier.ti.com	Audio	www.ti.com/audio
Data Converters	dataconverter.ti.com	Automotive	www.ti.com/automotive
DSP	dsp.ti.com	Broadband	www.ti.com/broadband
Interface	interface.ti.com	Digital Control	www.ti.com/digitalcontrol
Logic	logic.ti.com	Military	www.ti.com/military
Power Mgmt	power.ti.com	Optical Networking	www.ti.com/opticalnetwork
Microcontrollers	microcontroller.ti.com	Security	www.ti.com/security
RFID	www.ti-rfid.com	Telephony	www.ti.com/telephony
Low Power Wireless	www.ti.com/lpw	Video & Imaging	www.ti.com/video
		Wireless	www.ti.com/wireless

Mailing Address: Texas Instruments, Post Office Box 655303, Dallas, Texas 75265
Copyright © 2007, Texas Instruments Incorporated