

SERIES TL1105 SWITCHES

TACT SWITCHES - 6mm x 6mm

TACT SWITCHES

NAVIGATION SWITCHES

PUSHBUTTON SWITCHES

TOGGLE SWITCHES

ROCKER SWITCHES

SLIDE SWITCHES

SNAP-ACTION SWITCHES

DIP SWITCHES

KEYLOCK SWITCHES

ROTARY SWITCHES

DETECTOR SWITCHES

CAP OPTIONS



FEATURES & BENEFITS

- ▶ Reliable dome contact technology
- ▶ Strong tactile/audible feedback
- ▶ Multiple operating force options

APPLICATIONS/MARKETS

- ▶ Telecommunications
- ▶ Consumer Electronics
- ▶ Audio/visual
- ▶ Medical
- ▶ Testing/instrumentation
- ▶ Computer/servers/peripherals

SPECIFICATIONS

Contact Rating:	50mA @ 12 VDC (50mA @ 50VDC-gold)
Life Expectancy:	100,000 cycles
Contact Resistance:	100mΩ max., typical @ 2-4 VDC 100mA for both silver and gold plated contacts
Insulation Resistance:	100MΩ min.
Dielectric Strength:	250 VAC
Actuation Force:	100 ± 50 gf, 160 ± 50 gf, 250 ± 50 gf
Operating Temperature:	-20°C to 70°C
Travel:	0.25 Typ

MATERIALS

Housing:	Nylon or PBT
Actuator:	Nylon, Acetal or PBT
Cover:	Polyester
Contacts:	Gold or silver plated
Terminals:	Silver plated brass

HOW TO ORDER

SERIES	MODEL NO.	ACTUATOR ("L" Dimension)	OPERATING FORCE	CONTACT MTL./TERMINATION	CAP (Where Avail.)	CAP COLOR
TL TLE = Earth Ground	1105	(None) = 4.3mm A = 5.0mm B = 9.5mm C = 8.0mm D = 13.0mm E = 7.3mm F = 7.0mm G = 9.7mm H = 12.5mm K = 13.5mm L = 17.0mm P = 8.5mm Y = 16.3mm T = 2.4mm <input type="checkbox"/> SP = 2.8mm <input type="checkbox"/>	F100 F160 F250	Q = Silver R = Gold	See Cap Options Caps available for SP option only.	

- Square Snap-on Actuator Head
"L" Dimension is 7.5mm

TL	1105 (Rt. Angle)	V = 3.85mm W = 3.15mm X = 5.85mm R = 6.15mm M = 6.85mm S = 8.35mm N = 11.85mm Q = 15.85mm J = 2.4mm <input type="checkbox"/> JA = 2.8mm <input type="checkbox"/>	F100 F160 F250	Q = Silver R = Gold	See Cap Options Caps available for JA option only.	
----	---------------------	---	----------------------	------------------------	---	--

- Square Snap-on Actuator Head
"L" Dimension is 6.35mm

Example Ordering Number
TL-1105-SP-F160-Q-1R RED

Specifications subject to change without notice 2.28.2018



TL 1105

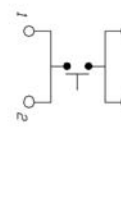

SCHEMATIC

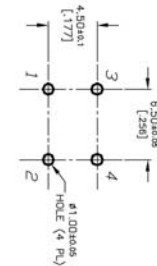

P.C. MOUNTING

TLE 1105

TLE (EARTH TERMINAL)

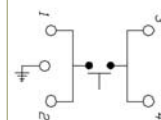
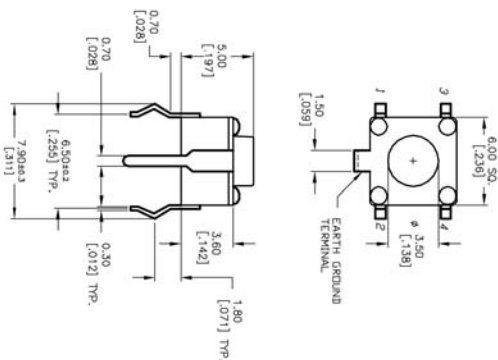

SCHEMATIC

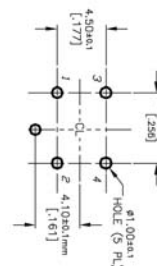

P.C. MOUNTING

TL 1105 T



Model No.	'S' Dim.
TL1105T	2.4 mm
TL1105SP	2.8 mm

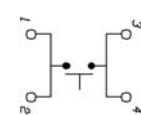
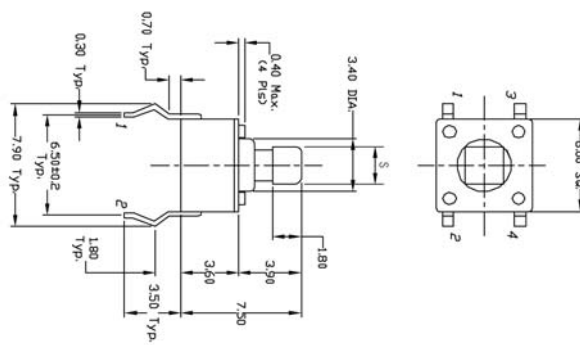

SCHEMATIC

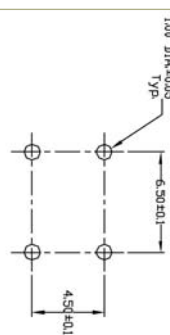

P.C. MOUNTING

- TACT SWITCHES
- NAVIGATION SWITCHES
- PUSHBUTTON SWITCHES
- TOGGLE SWITCHES
- ROCKER SWITCHES
- SLIDE SWITCHES
- SNAP-ACTION SWITCHES
- DIP SWITCHES
- KEYLOCK SWITCHES
- ROTARY SWITCHES
- DETECTOR SWITCHES
- CAP OPTIONS

SERIES TL1105 SWITCHES

TACT SWITCHES - 6mm x 6mm

TACT SWITCHES

TL 1105 J

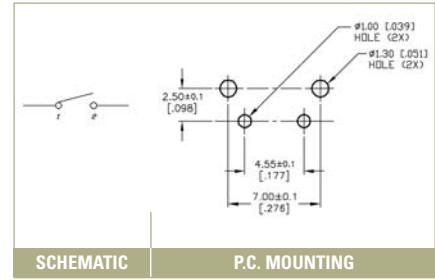
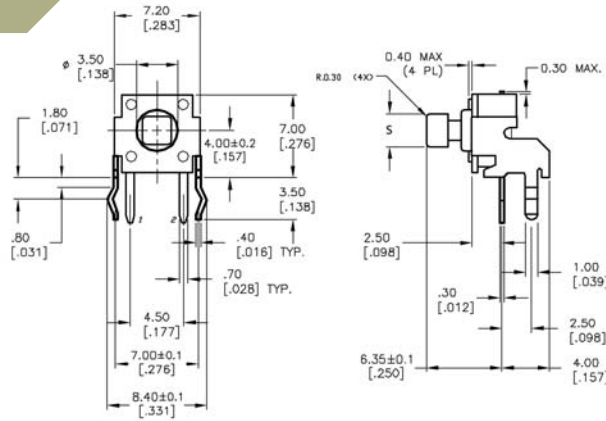

SCHEMATIC

P.C. MOUNTING

Model No.	'S' Dim.
TL1105J	□ 2.4 mm
TL1105JA	□ 2.8 mm

NAVIGATION SWITCHES

PUSHBUTTON SWITCHES

TOGGLE SWITCHES

ROCKER SWITCHES

TL 1105

RIGHT ANGLE

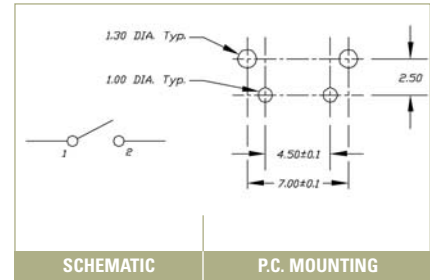

SCHEMATIC

P.C. MOUNTING

SLIDE SWITCHES

SNAP-ACTION SWITCHES

DIP SWITCHES

KEYLOCK SWITCHES

ROTARY SWITCHES

DETECTOR SWITCHES

CAP OPTIONS