





**BZX84C2V4 THRU BZX84C75**

PLASTIC-ENCAPSULATE ZENER DIODE



VOLTAGE	2.4~51 Volts	POWER	500.0 mW	SOT-23								
<b>FEATURES</b>		<p><b>PINNING</b></p> <table border="1"> <thead> <tr> <th>PIN</th> <th>DESCRIPTION</th> </tr> </thead> <tbody> <tr> <td>1</td> <td>Anode</td> </tr> <tr> <td>2</td> <td>N/A</td> </tr> <tr> <td>3</td> <td>Cathode</td> </tr> </tbody> </table>  			PIN	DESCRIPTION	1	Anode	2	N/A	3	Cathode
PIN	DESCRIPTION											
1	Anode											
2	N/A											
3	Cathode											
<ul style="list-style-type: none"> <li>Low Zener Impedance</li> <li>Power Dissipation of 300mW</li> <li>High Stability and High Reliability</li> <li>Zener Voltage Tolerance: ± 5%</li> </ul>												
<b>MECHANICAL DATA</b>												
<ul style="list-style-type: none"> <li>Case: SOT-23 Small Outline Plastic Package</li> <li>Epoxy UL: 94V-0</li> <li>Mounting position: Any</li> </ul>												
Maximum Ratings & Thermal Characteristics (Ratings at 25°C ambient temperature unless otherwise specified.)												
Parameter	Symbol	Value	Unit									
Power Dissipation	$P_d$	300 (Note1)	mW									
Forward Voltage @IF=10mA	$V_f$	0.9 (Note2)	V									
Junction temperature	$T_j$	150	°C									
Storage temperature range	$T_s$	-65-150	°C									
Storage temperature range	$R_{\theta JA}$	417	K / W									
Notes: 1. Valid provided that device terminals are kept at ambient temperature. 2. Test with pulse, period=5ms, pulse width=300us.												



**BZX84C2V4 THRU BZX84C75**

PLASTIC-ENCAPSULATE ZENER DIODE



**Electrical Characteristics** (Ratings at 25°C ambient temperature unless otherwise specified).

Device	MARKING	Zener Voltage Range				Maximum Zener Impedance			Maximum Reverse Current		Typical Temperature coefficient @ IZTC=mV/°C		Test Current IZTC
		V <sub>Z</sub> @I <sub>ZT</sub>			I <sub>ZT</sub>	Z <sub>ZT</sub> @I <sub>ZT</sub>	Z <sub>ZK</sub> @I <sub>ZK</sub>	I <sub>ZK</sub>	I <sub>R</sub>	V <sub>R</sub>	Min	Max	
		Min(V)	Nom(V)	Max(V)	mA	Ω		mA	uA	V	Min	Max	
BZX84C2V4	Z11	2.2	2.4	2.6	5	100	600	1.0	50	1.0	-3.5	0.0	5
BZX84C2V7	Z12	2.5	2.7	2.9	5	100	600	1.0	20	1.0	-3.5	0.0	5
BZX84C3V0	Z13	2.8	3.0	3.2	5	95	600	1.0	10	1.0	-3.5	0.0	5
BZX84C3V3	Z14	3.1	3.3	3.5	5	95	600	1.0	5	1.0	-3.5	0.0	5
BZX84C3V6	Z15	3.4	3.6	3.8	5	90	600	1.0	5	1.0	-3.5	0.0	5
BZX84C3V9	Z16	3.7	3.9	4.1	5	90	600	1.0	3	1.0	-3.5	0.0	5
BZX84C4V3	Z17	4.0	4.3	4.6	5	90	600	1.0	3	1.0	-3.5	0.0	5
BZX84C4V7	Z1	4.4	4.7	5.0	5	80	500	1.0	3	2.0	-3.5	0.2	5
BZX84C5V1	Z2	4.8	5.1	5.4	5	60	480	1.0	2	2.0	-2.7	1.2	5
BZX84C5V6	Z3	5.2	5.6	6.0	5	40	400	1.0	1	2.0	-2.0	2.5	5
BZX84C6V2	Z4	5.8	6.2	6.6	5	10	150	1.0	3	4.0	0.4	3.7	5
BZX84C6V8	Z5	6.4	6.8	7.2	5	15	80	1.0	2	4.0	1.2	4.5	5
BZX84C7V5	Z6	7.0	7.5	7.9	5	15	80	1.0	1	5.0	2.5	5.3	5
BZX84C8V2	Z7	7.7	8.2	8.7	5	15	80	1.0	0.7	5.0	3.2	6.2	5
BZX84C9V1	Z8	8.5	9.1	9.6	5	15	100	1.0	0.5	6.0	3.8	7.0	5
BZX84C10	Z9	9.4	10.0	10.6	5	20	150	1.0	0.2	7.0	4.5	8.0	5
BZX84C11	Y1-	10.4	11.0	11.6	5	20	150	1.0	0.1	8.0	5.4	9.0	5
BZX84C12	Y2-	11.4	12.0	12.7	5	25	150	1.0	0.1	8.0	6.0	10.0	5
BZX84C13	Y3	12.4	13.0	14.1	5	30	170	1.0	0.1	8.0	7.0	11.0	5
BZX84C15	Y4	13.8	15.0	15.6	5	30	200	1.0	0.1	10.5	9.2	13.0	5
BZX84C16	Y5	15.3	16.0	17.1	5	40	200	1.0	0.1	11.2	10.4	14.0	5
BZX84C18	Y6-	16.8	18.0	19.1	5	45	225	1.0	0.1	12.6	12.4	16.0	5
BZX84C20	Y7	18.8	20.0	21.2	5	55	225	1.0	0.1	14.0	14.4	18.0	5
BZX84C22	Y8	20.8	22.0	23.3	5	55	250	1.0	0.1	15.4	16.4	20.0	5
BZX84C24	Y9	22.8	24.0	25.6	5	70	250	1.0	0.1	16.8	18.4	22.0	5
BZX84C27	Y10	25.1	27.0	28.9	2	80	300	0.5	0.1	18.9	21.4	25.3	2
BZX84C30	Y11-	28.0	30.0	32.0	2	80	300	0.5	0.1	21.0	24.4	29.4	2
BZX84C33	Y12	31.0	33.0	35.0	2	80	325	0.5	0.1	23.1	27.4	33.4	2
BZX84C36	Y13	34.0	36.0	38.0	2	90	350	0.5	0.1	25.2	30.4	37.4	2
BZX84C39	Y14	37.0	39.0	41.0	2	130	350	0.5	0.1	27.3	33.4	41.2	2
BZX84C43	Y15	40.0	43.0	46.0	2	100	700	1.0	0.1	32.0	10.0	12.0	5
BZX84C47	Y16	44.0	47.0	50.0	2	100	750	1.0	0.1	35.0	10.0	12.0	5
BZX84C51	Y17	48.0	51.0	54.0	2	125	750	1.0	0.1	38.0	10.0	12.0	5
BZX84C56	Y18	52.0	56.0	60.0	2	135	700	1.0	0.1	39.0	10.0	12.0	5
BZX84C62	Y19	58.0	62.0	66.0	2	200	1000	1.0	0.2	47.0	10.0	12.0	5
BZX84C68	Y20	64.0	68.0	72.0	2	250	1000	1.0	0.2	52.0	10.0	12.0	5
BZX84C75	Y21-	70.0	75.0	79.0	2	300	1000	1.0	0.2	57.0	10.0	12.0	5

**BZX84C2V4 THRU BZX84C75**  
PLASTIC-ENCAPSULATE ZENER DIODE



**RATING AND CHARACTERISTIC CURVES**

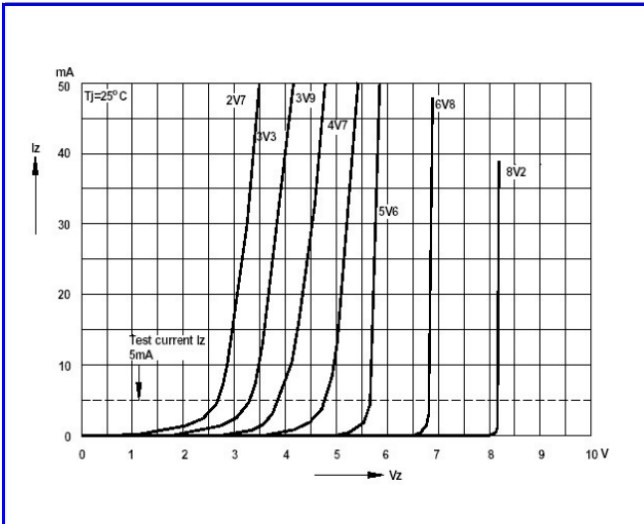

Fig.1-Breakdown characteristics

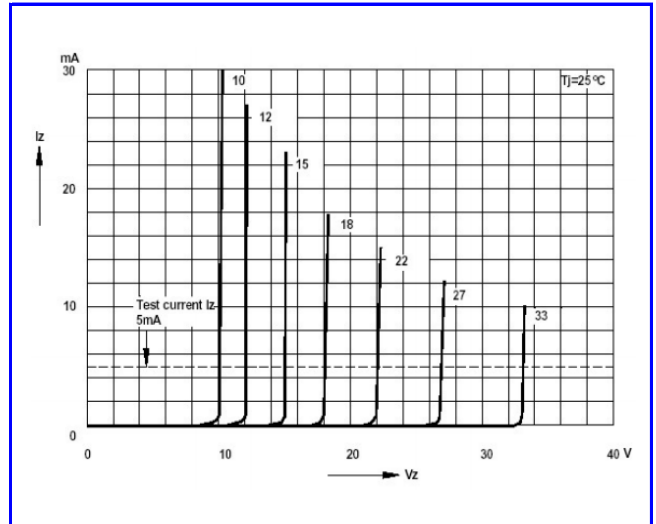

Fig.2- Breakdown characteristics

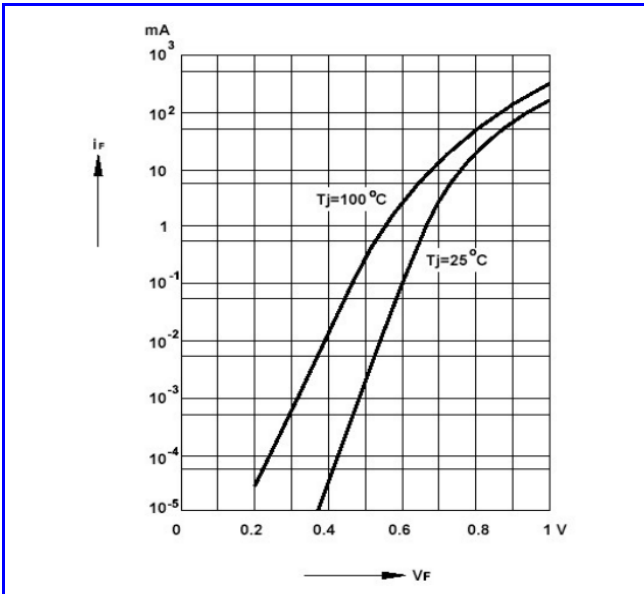

Fig.3- Forward characteristics

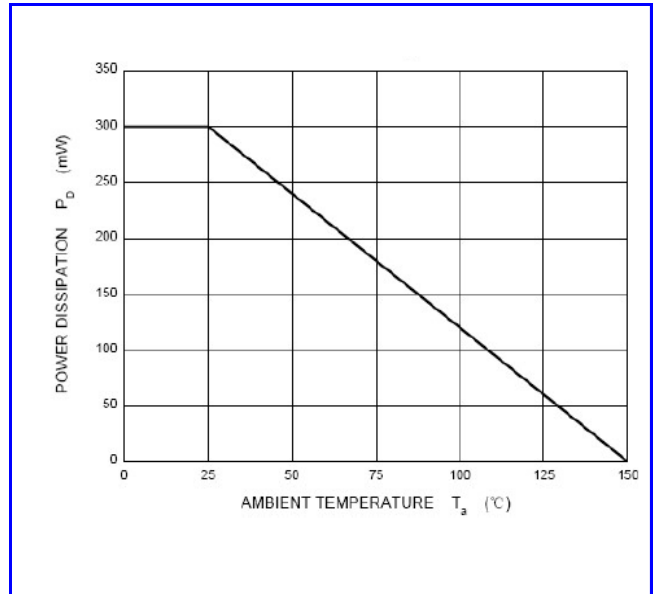

Fig.4- Admissible power dissipation versus ambient temperature

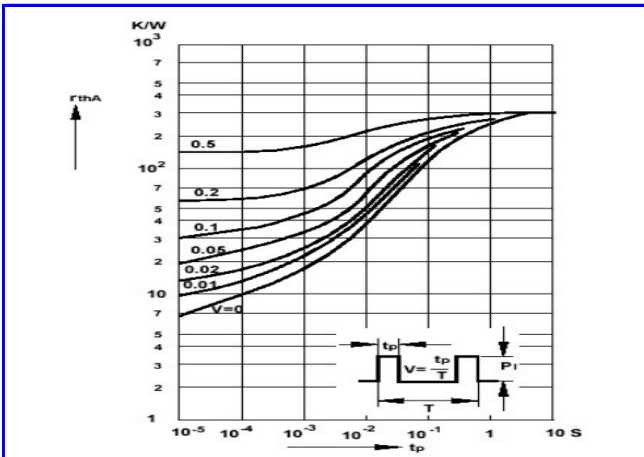

Fig.5-Pulse thermal resistance versus pulse duration

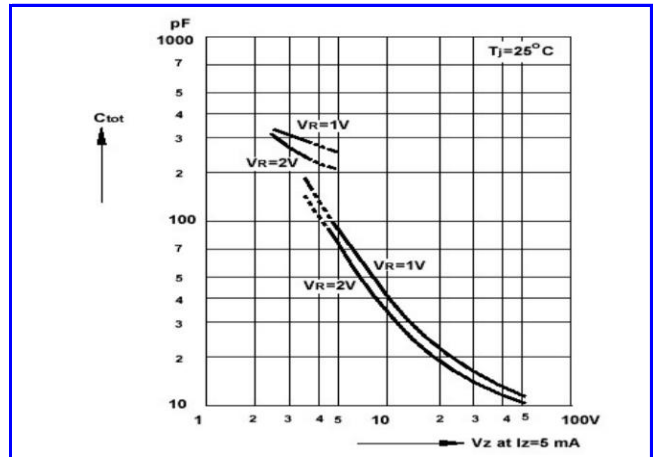

Fig.6-Capacitance versus Zener voltage

**BZX84C2V4 THRU BZX84C75**  
PLASTIC-ENCAPSULATE ZENER DIODE



**RATING AND CHARACTERISTIC CURVES**

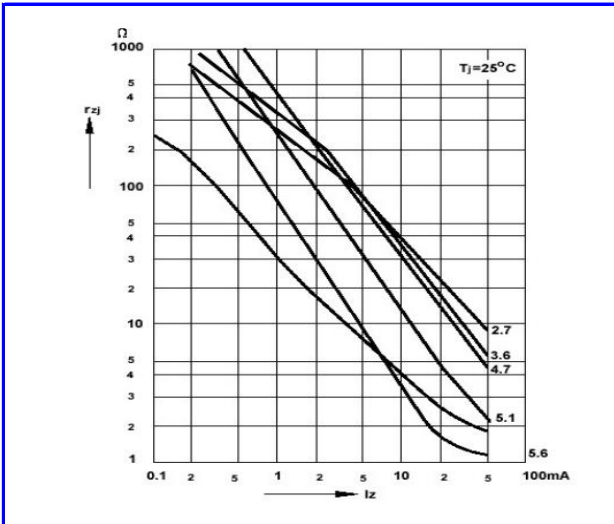

Fig.7-Dynamic resistance versus Zener current

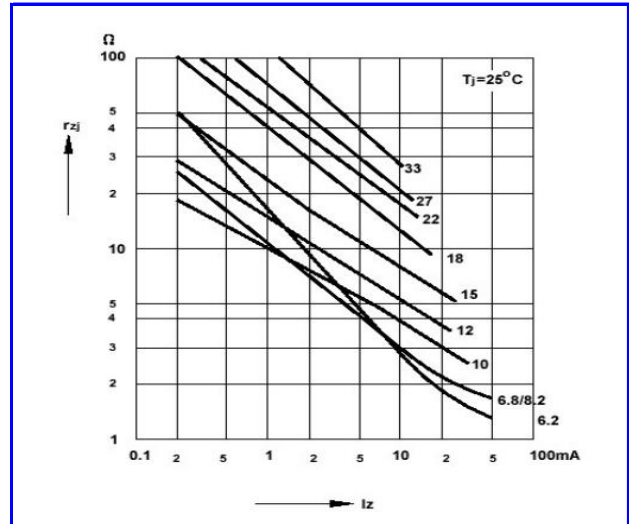

Fig.8-Dynamic resistance versus Zener current

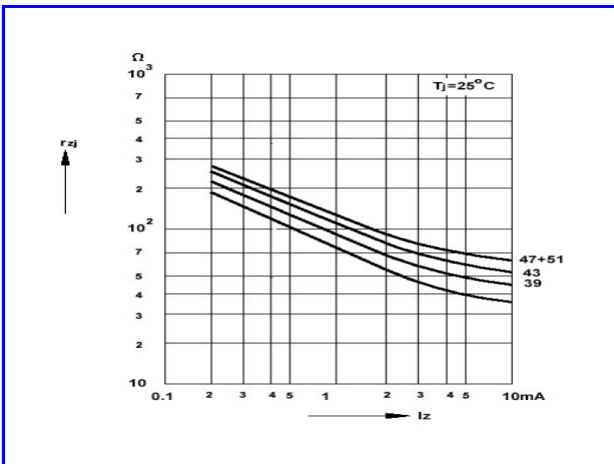

Fig.9-Dynamic resistance versus Zener current

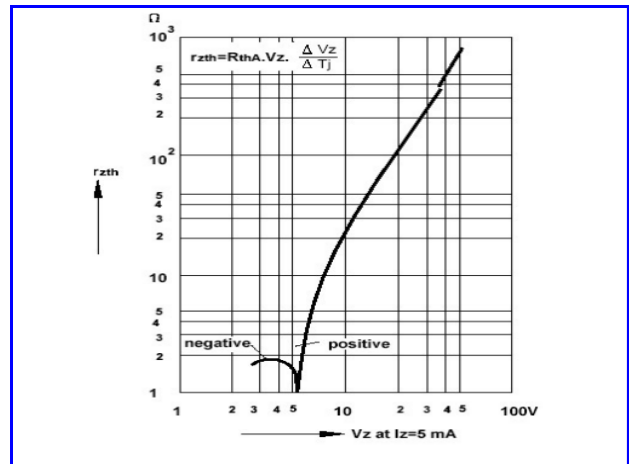

Fig.10-Thermal differential resistance versus Zener voltage

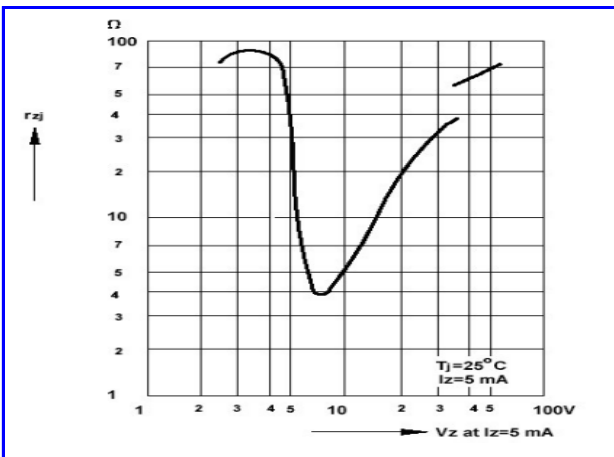

Fig.11-Dynamic resistance versus Zener voltage

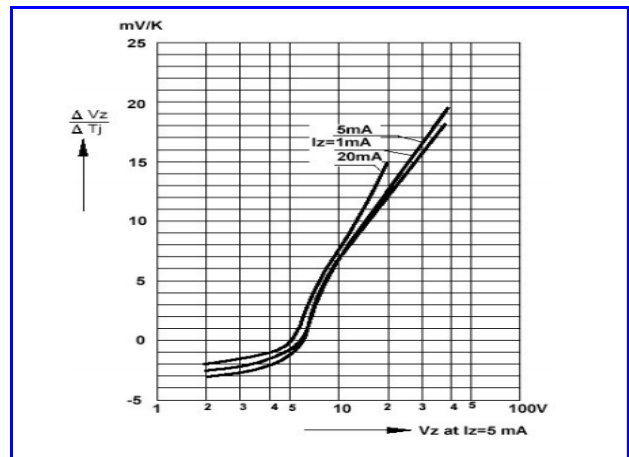

Fig.12-Temperature dependence of Zener voltage versus Zener voltage

**BZX84C2V4 THRU BZX84C75**  
PLASTIC-ENCAPSULATE ZENER DIODE



**RATING AND CHARACTERISTIC CURVES**

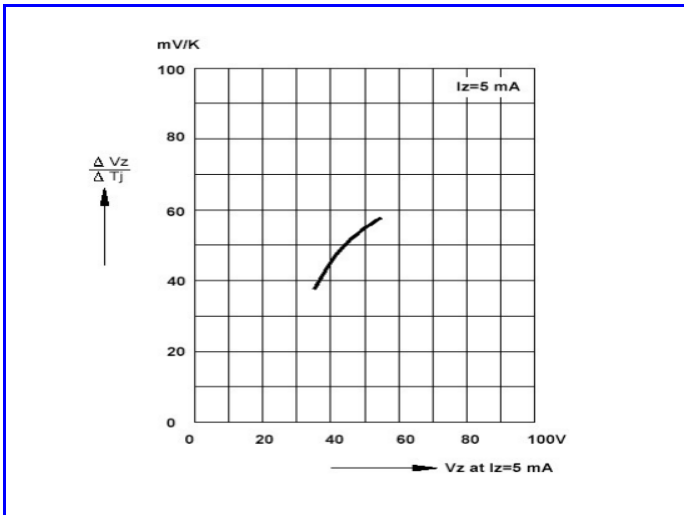

Fig.13-Temperature dependence of Zener voltage versus Zener voltage

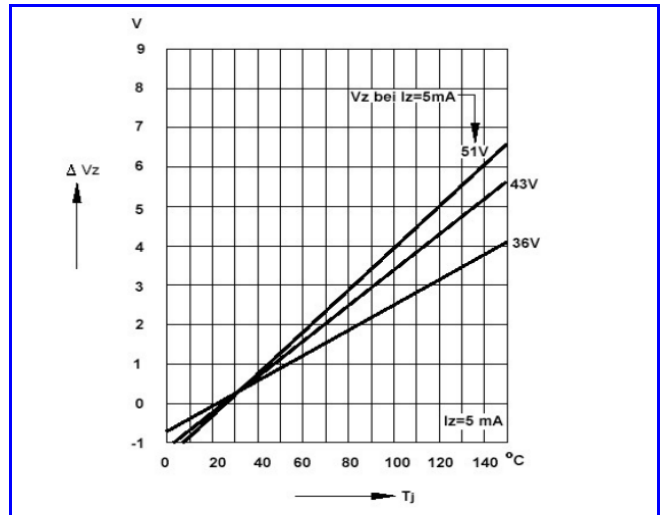

Fig.14-Change of Zener voltage versus junction temperature

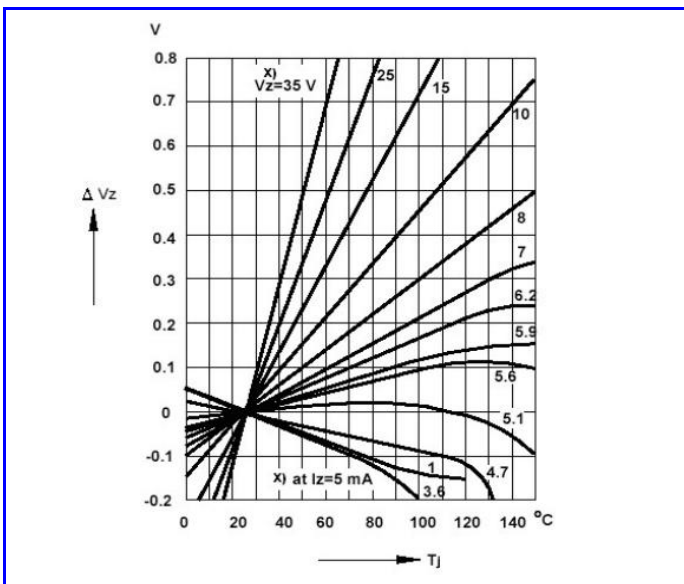

Fig.15- Change of Zener voltage versus junction temperature

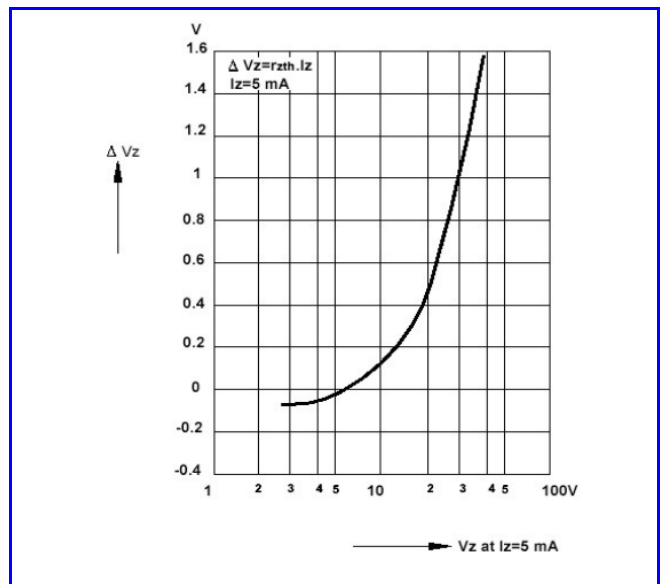
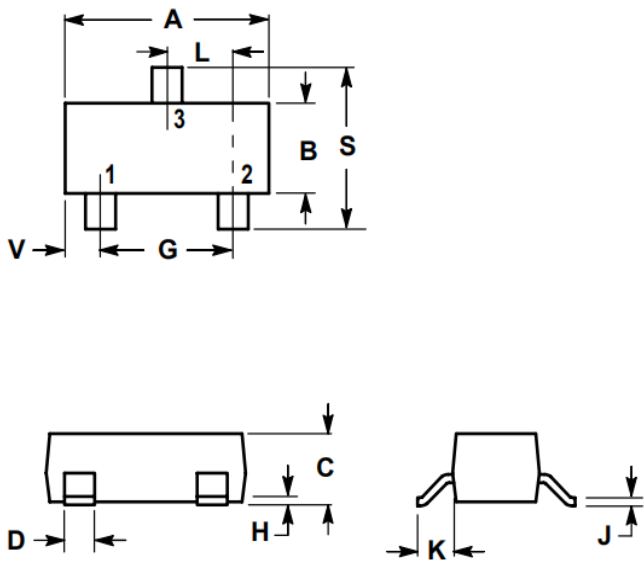

Fig.16- Change of Zener voltage from turn-on up to the point of thermal equilibrium versus Zener voltage

**BZX84C2V4 THRU BZX84C75**  
PLASTIC-ENCAPSULATE ZENER DIODE



**OUTLINE DRAWINGS**



**SOT-23**

OUTLINE DIMENSIONS						
Dim.	Millimeters			Inches		
	Min.	Typ.	Max.	Min.	Typ.	Max.
A	2.800	-	3.040	0.1102	-	0.1197
B	1.200	-	1.400	0.0472	-	0.0551
C	0.890	-	1.110	0.0350	-	0.0437
D	0.370	-	0.500	0.0146	-	0.0197
G	1.780	-	2.040	0.0701	-	0.0803
H	0.013	-	0.100	0.0005	-	0.0039
J	0.085	-	0.177	0.0033	-	0.0070
K	0.350	-	0.690	0.0138	-	0.0272
L	0.890	-	1.020	0.0350	-	0.0402
S	2.100	-	2.640	0.0827	-	0.1039
V	0.450	-	0.600	0.0177	-	0.0236

**MOUNTING PAD LAYOUT**

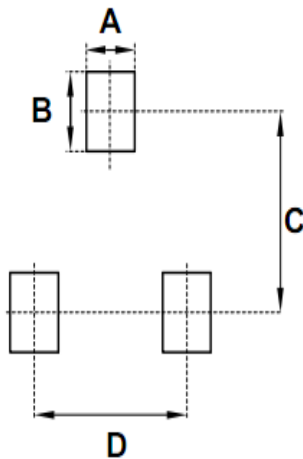

**SOT-23**

RECOMMENDED MOUNTING PAD DIMENSIONS						
Dim.	Millimeters			Inches		
	Min.	Typ.	Max.	Min.	Typ.	Max.
A	-	0.600	-	-	0.0236	-
B	-	0.800	-	-	0.0315	-
C	-	2.020	-	-	0.0795	-
D	-	1.900	-	-	0.0748	-

**PACKING INFORMATION**

**SOT-23**

Package Method	Reel Size (mm)	Quantity (pcs/reel)	Inner Box Size LxWxH(mm)	Quantity (pcs/Inner Box)	Carton Size LxWxH(mm)	Quantity (pcs/carton)
Tape Reel	Φ180	3000	340x340x40	6000	364x364x360	160000

**BZX84C2V4 THRU BZX84C75**

PLASTIC-ENCAPSULATE ZENER DIODE



**Recommended wave soldering condition**

Product	Peak Temperature	Soldering Time
Pb-free devices	260 +0/-5 °C	5 +1/-1 seconds

**Recommended temperature profile for IR reflow**

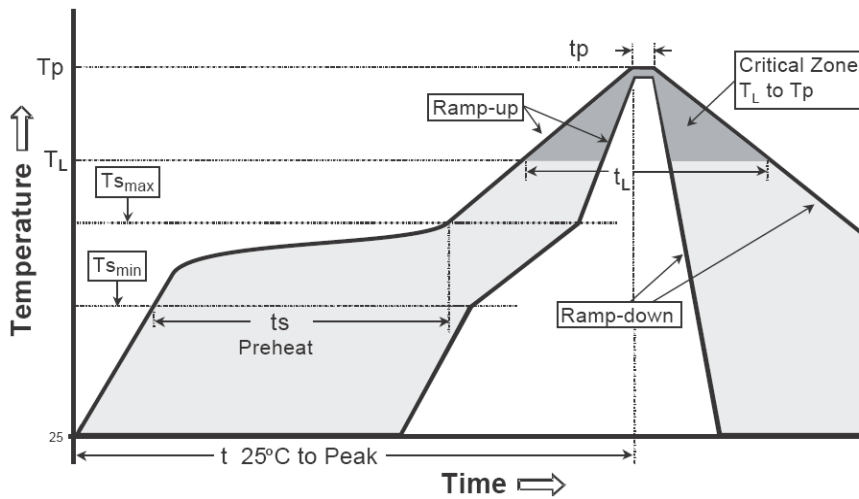

Profile feature	Sn-Pb eutectic Assembly	Pb-free Assembly
Average ramp-up rate (Tsmmax to Tp)	3°C/second max.	3°C/second max.
Preheat -Temperature Min(TS min) -Temperature Max(TS max) -Time(ts min to ts max)	100°C 150°C 60-120 seconds	150°C 200°C 60-180 seconds
Time maintained above: -Temperature (TL) - Time (tL)	183°C 60-150 seconds	217°C 60-150 seconds
Peak Temperature(TP)	240 +0/-5 °C	260 +0/-5 °C
Time within 5°C of actual peak temperature(tp)	10-30 seconds	20-40 seconds
Ramp down rate	6°C/second max.	6°C/second max.
Time 25 °C to peak temperature	6 minutes max.	8 minutes max.

Note : All temperatures refer to topside of the package, measured on the package body surface.

**BZX84C2V4 THRU BZX84C75**  
PLASTIC-ENCAPSULATE ZENER DIODE**Disclaimer**

- Reproducing and modifying information of the document is prohibited without permission from niuhang Electronics co., LTD
- Niuhan Electronics co., LTD. reserves the rights to make changes of the content herein the document anytime without notification.
- Niuhan Electronics co., LTD. disclaims any and all liability arising out of the application or use of any product including damages incidentally and consequentially occurred.
- Niuhan Electronics co., LTD. does not assume any and all implied warranties, including warranties of fitness for particular purpose, non-infringement and merchantability.
- Applications shown on the herein document are examples of standard use and operation. Customers are responsible in comprehending the suitable use in particular applications. Niuhan Electronics co., LTD. makes no representation or warranty that such applications will be suitable for the specified use without further testing or modification.
- The products shown herein are not designed and authorized for equipments requiring high level of reliability or relating to human life and for any applications concerning life-saving or life-sustaining, such as medical instruments, transportation equipment, aerospace machinery et cetera. Customers using or selling these products for use in such applications do so at their own risk and agree to fully indemnify Niuhan Electronics co., LTD. for any damages resulting from such improper use or sale.
- When the appearance of the product and chip size does not change, in order to product the customer quality, change the internal structure and the production process Niuhan can not notify