



# P-DUKE POWER

## MAD40 Multi Series

2 X 3.5 Inch AC-DC POWER SUPPLIES  
Up to 40 Watts

**5**  
YEARS  
WARRANTY

ROHS  
COMPLIANT

REACH  
COMPLIANT

+85°C  
-40°C  
AMBIENT TEMP.



Medical



Automation



Datacom



IPC



Industry



Measurement



Telecom



Automobile



Boat



Charger



PV



Railway

UL US CB CE UK CA



2 X MOPP
4000 VAC Isolation Voltage
ADJ. Output Voltage
Internal EN55032 Class B Filter
LOW Cross Reg.
LOW Leakage Current
LOW Standby Power
Operating Altitude 5000 meter
Protection Class I Class II
OPP
OVP
SCP

### PART NUMBER STRUCTURE

MAD	40	U						C	- xx	yy	-	
Series Name	Output Power (W)	Input Voltage (VAC)	Output Quantity	Output Voltage 1 (VDC)	Output Voltage 2 (VDC)	Output Voltage 3 (VDC)	Output Voltage 3 (VDC)	Protection Type	Vo2 Voltage Code	Vo3 Voltage Code		Connector Options
				Vo1	Vo2	Vo3 (Triple only)						
A: Open type U: U chassis type E: Enclosed type D: Din rail type		U: Universal 85 ~ 264	D: Dual T: Triple	3: 5V 4: 7.5V 5: 9V 6: 12V 7: 15V 8: 18V 9: 24V 0: 28V	1: 2.5V 2: 3.3V 3: 5V x: refer to Suffix xx	M: Minus □: Positive	1: 2.5V 2: 3.3V 3: 5V 4: 7.5V 5: 9V 6: 12V 7: 15V 8: 18V 9: 24V y: refer to Suffix yy	C: CLASS I D: CLASS II  □: CLASS I (※NRND) B: CLASS II (※NRND)				□: JST M: Molex T: Terminal Block
								※NRND: Not recommended for new designs				



**TECHNICAL SPECIFICATION** All specifications are typical at 230VAC input, full load and 25°C unless otherwise noted

Model Number	Output 1			Output 2			Output 3		Max. Output Power	Efficiency	Maximum Capacitor Load
	Voltage	Current (Normal)	Current (MAX)	Voltage	Current (Normal)	Current (MAX)	Voltage	Current (MAX)			
	VDC	A	A	VDC	A	A	VDC	A			
MAD40UD32C MUD40UD32C MED40UD32C MDD40UD32C	+5	5	8	+3.3	4	6	---	---	40	89.5	12000 / 2000
MAD40UD63C MUD40UD63C MED40UD63C MDD40UD63C	+12	2.1	3.34	+5	4	6	---	---	40	89	1750 / 2000
MAD40UD62C MUD40UD62C MED40UD62C MDD40UD62C	+12	2.1	3.34	+3.3	4	6	---	---	40	90	1750 / 2000
MAD40UD73C MUD40UD73C MED40UD73C MDD40UD73C	+15	1.7	2.67	+5	4	6	---	---	40	88.5	1670 / 2000
MAD40UD93C MUD40UD93C MED40UD93C MDD40UD93C	+24	1.05	1.67	+5	4	6	---	---	40	86	440 / 2000
MAD40UD03C MUD40UD03C MED40UD03C MDD40UD03C	+28	0.72	1.43	+5	4	6	---	---	40	85.5	220 / 2000
MAD40UT32M3C MUD40UT32M3C MED40UT32M3C MDD40UT32M3C	+5	5	8	+3.3	4	6	-5	0.5	40	89	10000 / 2000 / 420
MAD40UT326C MUD40UT326C MED40UT326C MDD40UT326C	+5	5	8	+3.3	4	6	+12	0.5	40	89	10000 / 2000 / 420
MAD40UT32M6C MUD40UT32M6C MED40UT32M6C MDD40UT32M6C	+5	5	8	+3.3	4	6	-12	0.5	40	89	10000 / 2000 / 420
MAD40UT63M3C MUD40UT63M3C MED40UT63M3C MDD40UT63M3C	+12	2.1	3.34	+5	4	6	-5	0.5	40	88.5	1750 / 2000 / 420
MAD40UT63M6C MUD40UT63M6C MED40UT63M6C MDD40UT63M6C	+12	2.1	3.34	+5	4	6	-12	0.5	40	88	1750 / 2000 / 420
MAD40UT623C MUD40UT623C MED40UT623C MDD40UT623C	+12	2.1	3.34	+3.3	4	6	+5	0.5	40	88.5	1750 / 2000 / 420



Model Number	Output 1			Output 2			Output 3		Max. Output Power	Efficiency	Maximum Capacitor Load
	Voltage	Current (Normal)	Current (MAX)	Voltage	Current (Normal)	Current (MAX)	Voltage	Current (MAX)			
	VDC	A	A	VDC	A	A	VDC	A			
MAD40UT62M6C MUD40UT62M6C MED40UT62M6C MDD40UT62M6C	+12	2.1	3.34	+3.3	4	6	-12	0.5	40	88	1750 / 2000 / 420
MAD40UT73M7C MUD40UT73M7C MED40UT73M7C MDD40UT73M7C	+15	1.7	2.67	+5	4	6	-15	0.5	40	88	1670 / 2000 / 420
MAD40UT936C MUD40UT936C MED40UT936C MDD40UT936C	+24	1.05	1.67	+5	4	6	+12	0.5	40	86	440 / 2000 / 420
MAD40UT93M6C MUD40UT93M6C MED40UT93M6C MDD40UT93M6C	+24	1.05	1.67	+5	4	6	-12	0.5	40	86	440 / 2000 / 420

### INPUT SPECIFICATIONS

Parameter	Conditions	Min.	Typ.	Max.	Unit
Operating input voltage range	AC input	85		264	VAC
	DC input	120		370	VDC
Input frequency	AC input	47		63	Hz
Input current	100VAC			1.05	A
	240VAC			0.55	A
No load input power	230VAC		0.15		Watts
Leakage current	264VAC		75		µA
Start up time				1000	ms
Rise time			20		ms
Hold up time	115VAC and Full Load		25		ms
Input inrush current	230VAC		60		A
Input protection	Internal fuse			T3.15A/250VAC	

OUTPUT SPECIFICATIONS							
Parameter	Conditions		Min.	Typ.	Max.	Unit	
Output power	Pout 1+Pout 2+Pout 3				40	Watts	
Initial set voltage accuracy	230VAC and Full Load	Vout 1	-1.0		+1.0	%	
		Vout 2 · Vout 3	-2.0		+2.0		
Line regulation	Low Line to High Line at Full Load		-0.2		+0.2	%	
Load regulation	No Load to Full Load	Vout 1	-0.5		+0.5	%	
		Vout 3	-0.7		+0.7		
		Vout 2	-1.5		+1.5		
	No Load to Full Load	Vout 2	-0.7		+0.7	%	
	0.1W Load to Full Load	Vout 2	-1.5		+1.5	%	
Cross regulation	Asymmetrical load 25%/100% FL		-1.5		+1.5	%	
Voltage adjustability			-10		+10	%	
Minimum load	M□D40UD□□			0		W	
	M□D40UT□□□; Vout 3 is full load			0.5			
Ripple and noise	Measured by 20MHz bandwidth					mVp-p	
	With a 10μF/25V 1206 X7R MLCC	Vout 1	5V		100		
		Vout 1	12V		120		
			15V		150		
			24V		240		
	With a 10μF/25V 1206 X7R MLCC	Vout 2	28V		280		
			All		100		
			Vout 3	5V			100
12V					120		
	15V		150				
Temperature coefficient			-0.02		+0.02	%/°C	
Transient response	Load step from 50 ~ 75% change at 2.5A/μs	Vout 1	Peak deviation		3	% Vout	
			Recovery time	600		μs	
Over voltage protection	% of Vout(nom); Latch mode	Vout 1		125	140	%	
Over power protection	% of nominal output power; Hiccup mode	Pout 1+Pout 2		145		%	
Short circuit protection			Continuous, automatics recovery				

GENERAL SPECIFICATIONS						
Parameter	Conditions		Min.	Typ.	Max.	Unit
Isolation voltage	1 minute (2MOPP insulation)	Input to Output	4000			VAC
		Input (Output) to F.G.	2500			
Isolation resistance	500VDC		0.1			GΩ
Switching frequency	230VAC	Vout 1	5V	70		kHz
			Others	115		
		Vout 2		750		
			Vout 3		510	
Safety approvals	IEC/ EN/ ANSI/AAMI ES 60601-1 IEC/ EN/ UL 62368-1					UL:E360199 UL:E193009 CB:UL(Demko)
Weight						150 (5.29oz)
						198 (6.98oz)
						216 (7.62oz)
						238 (8.40oz)
MTBF	MIL-HDBK-217F, Full load					1.716 x 10 <sup>6</sup> hrs

ENVIRONMENTAL SPECIFICATIONS						
Parameter	Conditions		Min.	Typ.	Max.	Unit
Operating ambient temperature	With derating		-40		+85	°C
Storage temperature range			-40		+85	°C
Operating altitude					5000	m
Shock			IEC60068-2-27			
Vibration			IEC60068-2-6			
Relative humidity	Non-condensing		5% to 95% RH			

## EMC SPECIFICATIONS

Parameter	Conditions	Level
EMI	EN55011, EN55032, EN60601-1-2 and FCC Part 18 / 15 External components may be required for class I application.	Conducted Class B Radiated Class B
Harmonic currents	EN61000-3-2 Full Load	Class A
Voltage flicker	EN61000-3-3	
EMS	EN55035 and EN60601-1-2	
ESD	EN61000-4-2	Perf. Criteria A
Radiated immunity	EN61000-4-3 20 V/m	Perf. Criteria A
Fast transient	EN61000-4-4 $\pm 2kV$	Perf. Criteria A
Surge	EN61000-4-5 DM $\pm 1kV$ and CM $\pm 2kV$	Perf. Criteria A
Conducted immunity	EN61000-4-6 20 Vr.m.s	Perf. Criteria A
Power frequency magnetic field	EN61000-4-8 30 A/m	Perf. Criteria A
Dip and interruptions	EN61000-4-11	

## CHARACTERISTIC CURVE

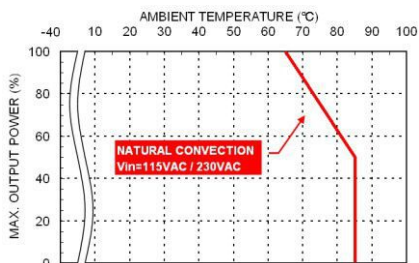

Derating Curve vs. Ambient Temperature  
M□D40UD

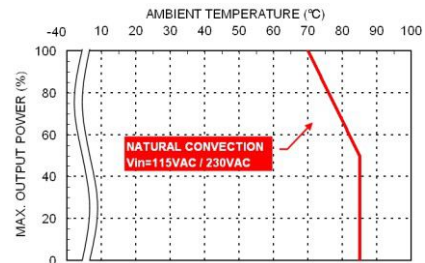

Derating Curve vs. Ambient Temperature  
M□D40UT

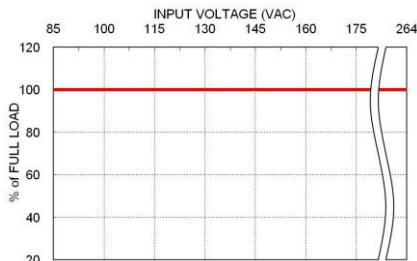

Derating Curve vs. Input Voltage  
M□D40

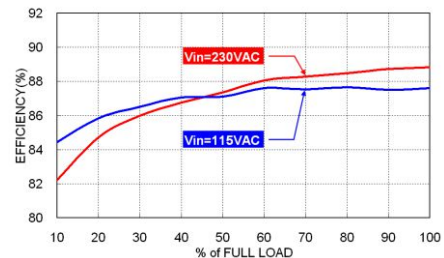

Efficiency vs. Output Load  
M□D40UT63M6B

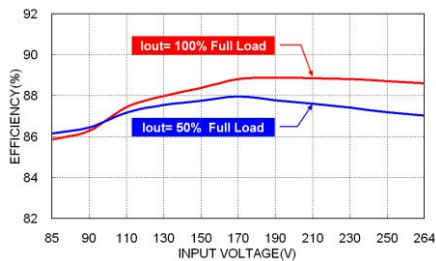

Efficiency vs. Input Voltage  
M□D40UT63M6B

**MECHANICAL DRAWING**

**MAD** Open type

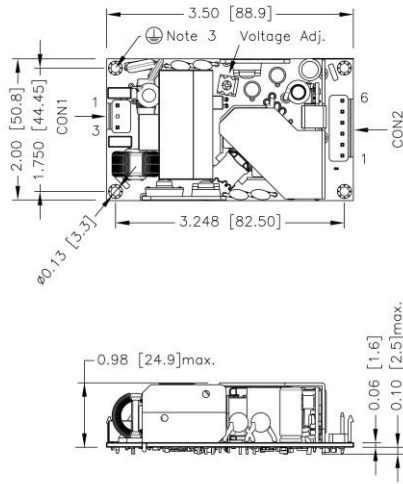

FRONT VIEW

- 1.All dimensions in inch[mm]  
Tolerance:x.xx±0.02[x.x±0.5] x.xxx±0.010[x.xx±0.25]
- 2.The screw locked torque: MAX 5.0kgf-cm/0.49N-m
- 3.The screws holes can be considered as PE connection for CLASS I application.

**MDD** Din rail type

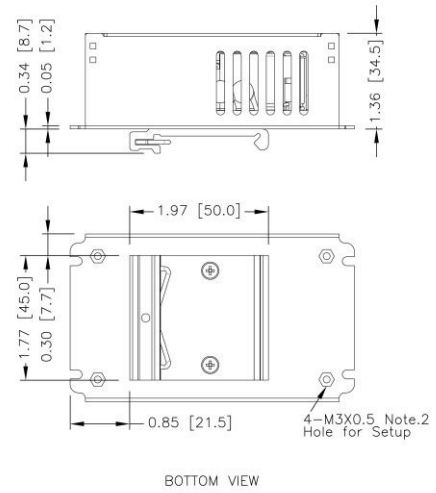

BOTTOM VIEW

- 1.All dimensions in inch[mm]  
Tolerance:x.xx±0.02[x.x±0.5] x.xxx±0.010[x.xx±0.25]
- 2.The screw locked torque: MAX 5.0kgf-cm/0.49N-m

**MED** Enclosed type

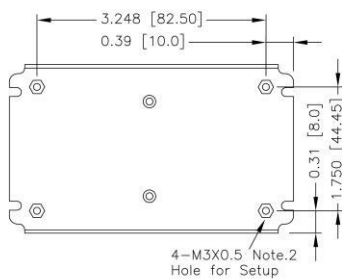
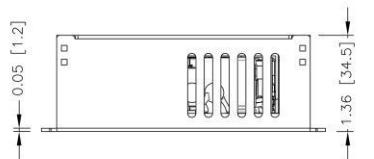
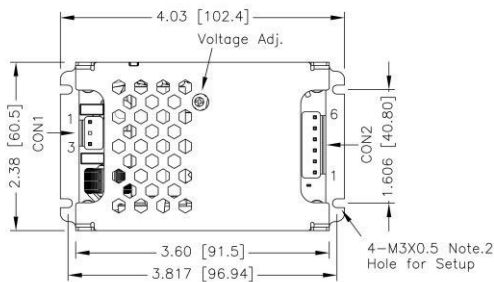

BOTTOM VIEW

- 1.All dimensions in inch[mm]  
Tolerance:x.xx±0.02[x.x±0.5] x.xxx±0.010[x.xx±0.25]
- 2.The screw locked torque: MAX 5.0kgf-cm/0.49N-m

**MUD** U chassis type

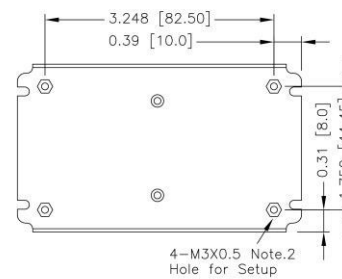
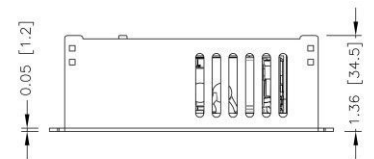
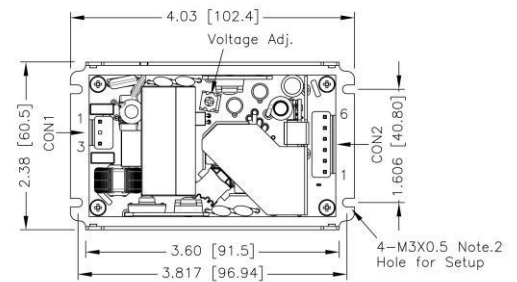

BOTTOM VIEW

- 1.All dimensions in inch[mm]  
Tolerance:x.xx±0.02[x.x±0.5] x.xxx±0.010[x.xx±0.25]
- 2.The screw locked torque: MAX 5.0kgf-cm/0.49N-m



## CONNECTOR CONNECTIONS

CON1 – Input Connector		
Pin Number	AC Input	DC Input
		M□D40UDXXC · M□D40UDXXD M□D40UTXXC · M□D40UTXXD
Pin 1	Line	DC+
Pin 3	Neutral	DC-

CON2 – Output Connector	
Pin 1	Vout3
Pin 2,3	Com
Pin 4,5	Vout2
Pin 6	Vout1

\*Either one of four screws holes of Chassis type can be considered as PE connection for CLASS I application.

## CONNECTOR OPTIONS

Blank:	JST Type	-M	Molex Type	-T	Terminal Block
	Mates with housing <b>CON1: VHR-3N</b> <b>CON2: VHR-6N</b>		Mates with housing <b>CON1: 09-50-8031</b> <b>CON2: 09-50-8061</b>		Screw locked torque <b>MAX 2Kgf.cm/0.2N.m</b>
	Crimp terminals <b>CON1: SVH-21T-P1.1</b> <b>CON2: SVH-21T-P1.1</b>		Crimp terminals <b>CON1: SD-2478</b> <b>CON2: SD-2478</b>		Wire dimension range <b>26 ~ 16AWG</b>