



Features

- Up to 75W Output: 20A @3.3V, 15A @5V
- Input Voltage Range: 36V to 75V
- Programmable Output Voltage
- 91% Efficiency (PT4403)
- 1500 VDC Isolation
- On/Off Control
- Over-Current Protection
- Differential Remote Sense
- Output Over-Voltage Protection
- Over-Temperature Shutdown
- Undervoltage Lockout
- Low Profile Package (12mm)
- Compact PCB Layout: (Horizontal Config. 1.45in × 2.6in, Vertical Config. < 1 in²)
- Solderable Copper Case
- Agency Approvals Pending

Description

The PT4400 series of power modules are single-output isolated DC/DC converters, housed in a compact 21-pin low-profile (12mm) package. These modules are rated up to 75W with load currents as high as 20A. The output voltage is set within a pre-defined range via a 5-bit input code.

The PT4400 series operates from a standard 48-V telecom CO supply and occupies only 3.9in² of PCB area. These modules offer OEMs a compact and flexible high-output power source for use with high-end microprocessors, DSPs, general purpose logic and analog. They are suitable for distributed power applications in both telecom and computing environments.

Features include output over-current protection, on/off control, output over-voltage protection (OVP), over-temperature shutdown, under-voltage lockout (UVLO), and an output differential remote sense. The modules are fully integrated for stand-alone operation, and require no additional components.

Ordering Information

- PT4401□ = 1.3 to 3.5 Volts
 PT4402□ = 1.05 to 1.75 Volts
 PT4403□ = 3.4 to 5.7 Volts

PT Series Suffix (PT1234 x)

Case/Pin Configuration	Order Suffix	Package Code
Vertical	N	(ENM)
Horizontal	A	(ENN)
SMD	C	(ENP)

(Reference the applicable package code drawing for the dimensions and PC layout)

Pin-Out Information

Pin	Function
1	Remote On/Off*
2	-V _{in}
3	-V _{in}
4	+V _{in}
5	+V _{in}
6	Pin Not Present
7	VID 0
8	VID 1
9	VID 2
10	VID 3
11	VID 4†
12	(-)Remote Sense
13	-V _o
14	-V _o
15	-V _o
16	-V _o
17	+V _o
18	+V _o
19	+V _o
20	+V _o
21	(+)Remote Sense

* For more information consult the applicable application note.
 † VID 4 does not function on the PT4402 & PT4403

Standard Application

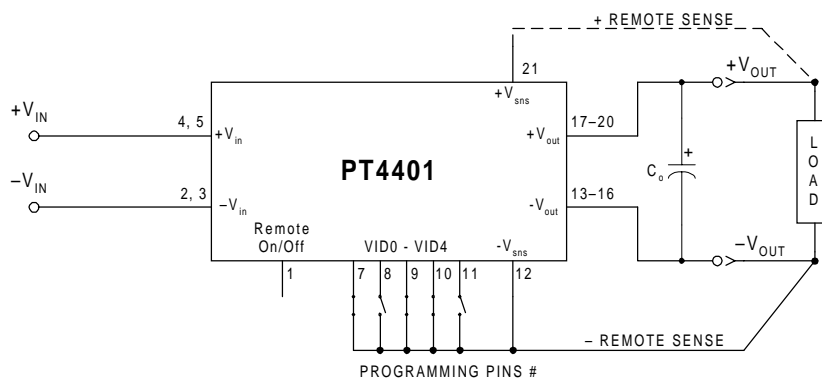

C_o = Optional 330µF Electrolytic Capacitor
 #VID programming pins set for 3.3V output

Environmental Specifications

Characteristics	Symbols	Conditions	Min	Typ	Max	Units
Operating Temperature Range	T _a	Over V _{in} Range	-40	—	+85 ⁽ⁱ⁾	°C
Storage Temperature	T _s	—	-40	—	+125	°C
Mechanical Shock		Per Mil-STD-883D, Method 2002.3 1 msec, ½ Sine, mounted	—	TBD	—	G's
Mechanical Vibration		Mil-STD-883D, Method 2007.2 20-2000 Hz, PCB mounted	—	TBD ⁽ⁱⁱ⁾ TBD ⁽ⁱⁱ⁾	—	G's
Weight	—	Vertical/Horizontal	—	50	—	grams
Shutdown Temperature	OTP	Case temperature - auto reset	—	115	—	°C
Flammability	—	Meets UL 94V-O				

Notes (i) See SOA curves or consult factory for appropriate derating

(ii) The case pins on the through-hole package types (suffixes N & A) must be soldered. For more information see the applicable package outline drawing.

Output Voltage Programming Information

VID3	VID2	VID1	VID0	PT4401		PT4402	PT4403
				VID4=1 Vout	VID4=0 Vout	VID4= × † Vout	VID4= × † Vout
1	1	1	1	N/D *	1.30V	N/D *	N/D *
1	1	1	0	2.10V	1.35V	1.05V	3.40V
1	1	0	1	2.20V	1.40V	1.10V	3.56V
1	1	0	0	2.30V	1.45V	1.15V	3.72V
1	0	1	1	2.40V	1.50V	1.20V	3.88V
1	0	1	0	2.50V	1.55V	1.25V	4.05V
1	0	0	1	2.60V	1.60V	1.30V	4.21V
1	0	0	0	2.70V	1.65V	1.35V	4.37V
0	1	1	1	2.80V	1.70V	1.40V	4.53V
0	1	1	0	2.90V	1.75V	1.45V	4.69V
0	1	0	1	3.00V	1.80V	1.50V	4.86V
0	1	0	0	3.10V	1.85V	1.55V	5.02V
0	0	1	1	3.20V	1.90V	1.60V	5.18V
0	0	1	0	3.30V	1.95V	1.65V	5.34V
0	0	0	1	3.40V	2.00V	1.70V	5.50V
0	0	0	0	3.50V	2.05V	1.75V	5.67V

Logic 0 = Pin 12 potential; (-)Remote Sense
Logic 1 = Open circuit (no pull-up resistors)

* N/D = Output voltage is not defined

† VID 4 (pin 11) of PT4402 & PT4403 is don't care (×).

Note: During operation, changes to the program code should be limited to 15% of V_o so as to avoid activating the output OV protection.

Pin Descriptions

+Vin: The positive input for the module with respect to -V_{in}. When powering the module from a -48V telecom central office supply, this input is connected to the primary system ground.

-Vin: The negative input supply for the module, and the 0VDC reference for the Remote On/Off input. When powering the module from a +48V supply, this input is connected to the 48V(Return).

Remote On/Off: A positive logic input that is referenced to -V_{in}. Pulling this input down to -V_{in} potential disables the module's output. If this input is left open-circuit, the module will produce an output whenever a valid input source is applied.

VID0 – VID4: Selects the set-point output voltage of the converter according to the applicable program code. VID0 – VID4 must either be connected to (-)Remote Sense or left open circuit. *Note: For the PT4402 & PT4403, VID 4 is internally disabled and may be left open circuit.*

+Vo: The positive power output with respect to -V_o, which is DC isolated from the input supply pins. If a negative output voltage is desired, +V_o should be connected to the secondary circuit common and the output taken from -V_o.

-Vo: The negative power output with respect to +V_o, which is DC isolated from the input supply pins. This output is normally connected to the secondary circuit common when a positive output voltage is desired.

+Remote Sense: Provides the converter with remote sense capability to regulate the set-point voltage directly at the load. When used with -Remote Sense, the regulation circuitry will compensate for voltage drop between the converter and the load. The pin may be left open circuit, but connecting it to +V_o will improve load regulation.

-Remote Sense: This is the logic '0' reference for the inputs VID0 – VID4, and provides the converter with remote sense capability when used in conjunction with +Remote Sense. For optimum output voltage accuracy this pin should always be connected to -V_o.

PT4401—48V

75-W 48-V Input Isolated
DC/DC Converter

PT4401 Specifications (Unless otherwise stated, $T_a = 25^\circ\text{C}$, $V_{in} = 48\text{V}$, $V_o = 3.3\text{V}$, $C_o = 0\mu\text{F}$, and $I_o = I_{o,max}$)

Characteristic	Symbol	Conditions	PT4401			Units
			Min	Typ	Max	
Output Current	I_o	Over V_{in} range	0	—	20	A
Input Voltage Range	V_{in}	Over I_o Range	36	48	75	V
Set Point Voltage Tolerance	V_o tol		—	± 0.6 (1)	—	% V_o
Temperature Variation	Reg_{temp}	$-40^\circ > T_a > +85^\circ\text{C}$	—	± 0.8	—	% V_o
Line Regulation	Reg_{line}	Over V_{in} range	—	± 1	—	mV
Load Regulation	Reg_{load}	Over I_o range	—	± 1	—	mV
Total Output Voltage Variation	$\Delta V_{o,tot}$	Includes set-point, line, load, $-40^\circ > T_a > +85^\circ\text{C}$	—	± 1.6	± 3	% V_o
Efficiency	η		—	89	—	%
V_o Ripple (pk-pk)	V_r	20MHz bandwidth	—	50	—	mV _{pp}
Transient Response	t_{tr}	1A/ μs load step, 50% to 100% $I_{o,max}$	—	75	—	μs
	ΔV_{tr}	V_o over/undershoot	—	± 5	—	% V_o
Over-Current Threshold	I_{TRIP}	Shutdown, followed by auto-recovery	—	26	—	A
Output Over-Voltage Protection	OVP	Output shutdown and latch off	—	125	—	% V_o
Switching Frequency	f_o	Over V_{in} range	—	300	—	kHz
Under-Voltage Lockout	UVLO		—	32	—	V
Remote On/Off Input	V_{IH} V_{IL} I_{IL}	Referenced to $-V_{in}$	4.5	—	Open (2)	V
Input High Voltage			-0.2	—	+0.8	
Input Low Voltage			—	-0.3	—	
Input Low Current			—	2	—	mA
Standby Input Current	$I_{in, standby}$	pins 1 & 2 connected	—	2	—	mA
Internal Input Capacitance	C_{in}		—	1.4	—	μF
External Output Capacitance	C_{out}	Between $+V_o$ and $-V_o$	0	—	5,000	μF
Isolation Voltage	Capacitance	Input-output & input-case	1500	—	—	Vdc
		Input-output	—	1200	—	pF
		Input-output	10	—	—	M Ω

Notes: (1) If (-)Remote Sense is not used, pin 12 must be connected to pin 13 for optimum output voltage accuracy.

(2) The Remote On/Off input has an internal pull-up. If it is left open-circuit the module will operate when input power is applied. A discrete MOSFET or bipolar transistor is recommended to control this input. The open-circuit voltage is typically 5V. See application notes for interface considerations.

PT4401 Characteristic Data

Efficiency vs Load Current; $V_{in} = 48\text{V}$ (See Note A)

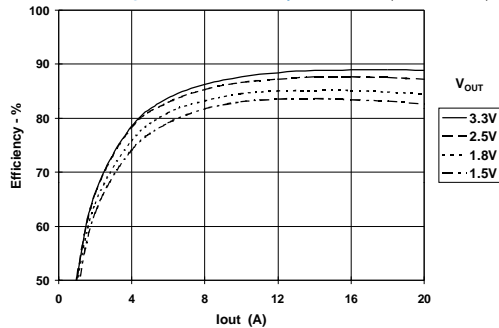

Power Dissipation vs Load Current; $V_o = 3.3\text{V}$ (See Note A)

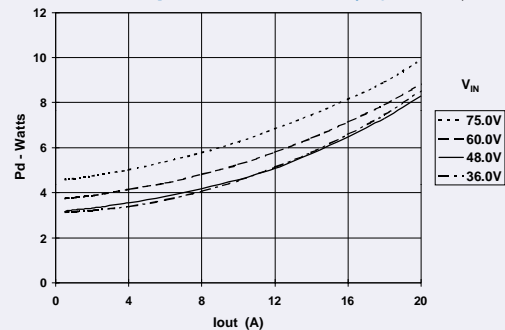

Output Ripple vs Load Current; $V_{in} = 48\text{V}$ (See Note A)

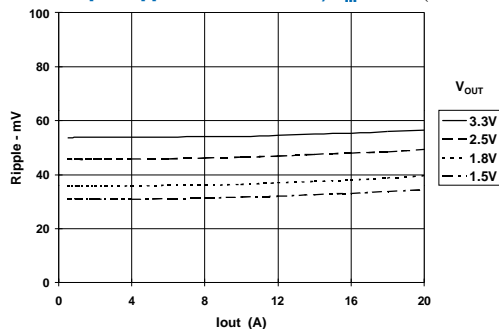

Safe Operating Area; $V_{in} = 48\text{V}$ (See Note B)

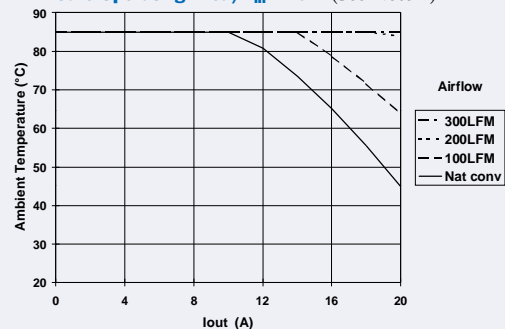

Note A: All data listed in the above graphs has been developed from actual products tested at 25°C . This data is considered typical data for the DC-DC Converter.

Note B: SOA curves represent operating conditions at which internal components are at or below manufacturer's maximum rated operating temperature.

PT4402—48V

75-W 48-V Input Isolated
DC/DC Converter

PT4402 Specifications (Unless otherwise stated, $T_a = 25^\circ\text{C}$, $V_{in} = 48\text{V}$, $V_o = 1.5\text{V}$, $C_o = 0\mu\text{F}$, and $I_o = I_{o,max}$)

Characteristic	Symbol	Conditions	PT4402			Units
			Min	Typ	Max	
Output Current	I_o	Over V_{in} range	0	—	20	A
Input Voltage Range	V_{in}	Over I_o Range	36	48	75	V
Set Point Voltage Tolerance	V_o tol		—	± 0.6 (1)	—	% V_o
Temperature Variation	Reg_{temp}	$-40^\circ > T_a > +85^\circ\text{C}$	—	± 0.8	—	% V_o
Line Regulation	Reg_{line}	Over V_{in} range	—	± 1	—	mV
Load Regulation	Reg_{load}	Over I_o range	—	± 1	—	mV
Total Output Voltage Variation	$\Delta V_{o,tot}$	Includes set-point, line, load, $-40^\circ > T_a > +85^\circ\text{C}$	—	± 1.6	± 3	% V_o
Efficiency	η	$I_o = 10\text{A}$	—	84	—	%
V_o Ripple (pk-pk)	V_r	20MHz bandwidth	—	40	—	mV _{pp}
Transient Response	t_{tr}	1A/ μs load step, 50% to 100% $I_{o,max}$	—	75	—	μs
	ΔV_{tr}	V_o over/undershoot	—	± 3	—	% V_o
Over-Current Threshold	I_{TRIP}	Shutdown, followed by auto-recovery	—	28	—	A
Output Over-Voltage Protection	OVP	Output shutdown and latch off	—	125	—	% V_o
Switching Frequency	f_o	Over V_{in} range	—	300	—	kHz
Under-Voltage Lockout	UVLO		—	32	—	V
Remote On/Off Input		Referenced to $-V_{in}$				
Input High Voltage	V_{IH}		4.5	—	Open (2)	V
Input Low Voltage	V_{IL}		-0.2	—	+0.8	V
Input Low Current	I_{IL}		—	-0.3	—	mA
Standby Input Current	$I_{in, standby}$	pins 1 & 2 connected	—	2	—	mA
Internal Input Capacitance	C_{in}		—	1.4	—	μF
External Output Capacitance	C_{out}	Between $+V_o$ and $-V_o$	0	—	5,000	μF
Isolation Voltage		Input-output & input-case	1500	—	—	Vdc
Capacitance		Input-output	—	1200	—	pF
Resistance		Input-output	10	—	—	$\text{M}\Omega$

Notes: (1) If (-) Remote Sense is not used, pin 12 must be connected to pin 13 for optimum output voltage accuracy.

(2) The Remote On/Off input has an internal pull-up. If it is left open-circuit the module will operate when input power is applied. A discrete MOSFET or bipolar transistor is recommended to control this input. The open-circuit voltage is typically 5V. See application notes for interface considerations.

PT4402 Characteristic Data

Efficiency vs Load Current; $V_{in} = 48\text{V}$ (See Note A)

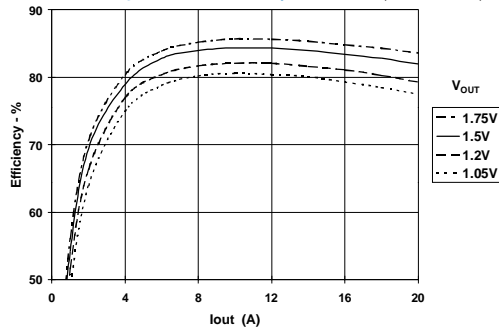

Power Dissipation vs Load Current; $V_o = 1.5\text{V}$ (See Note A)

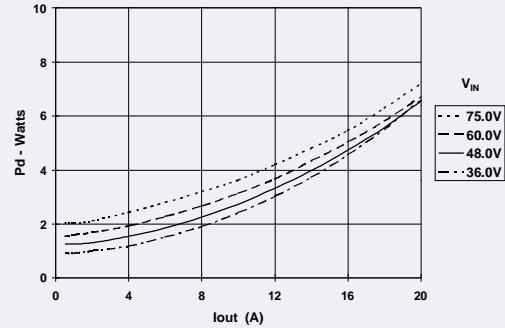

Output Ripple vs Load Current; $V_{in} = 48\text{V}$ (See Note A)

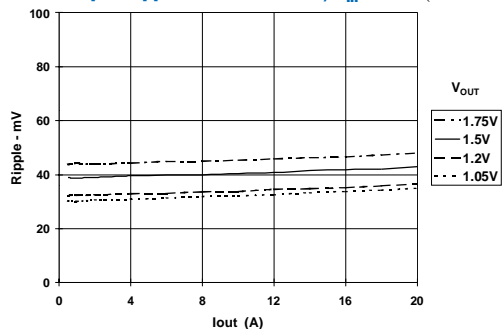

Safe Operating Area; $V_{in} = 48\text{V}$ (See Note B)

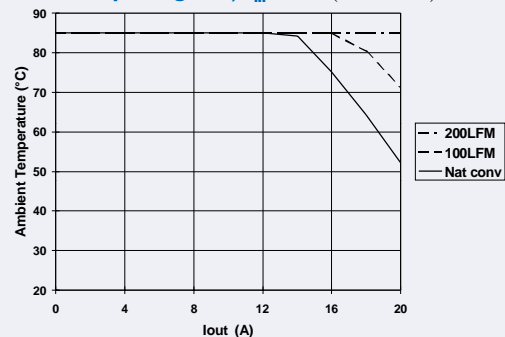

Note A: All data listed in the above graphs has been developed from actual products tested at 25°C . This data is considered typical data for the DC-DC Converter.

Note B: SOA curves represent operating conditions at which internal components are at or below manufacturer's maximum rated operating temperature.

PT4403—48V

75-W 48-V Input Isolated DC/DC Converter

PT4403 Specifications (Unless otherwise stated, $T_a = 25^\circ\text{C}$, $V_{in} = 48\text{V}$, $V_o = 5.02\text{V}$, $C_o = 0\mu\text{F}$, and $I_o = I_{o\text{max}}$)

Characteristic	Symbol	Conditions	PT4403			Units
			Min	Typ	Max	
Output Current	I_o	Over V_{in} range	0	—	15	A
Input Voltage Range	V_{in}	Over I_o Range	36	48	75	V
Set Point Voltage Tolerance	$V_o\text{tol}$		—	± 0.6 (1)	—	$\%V_o$
Temperature Variation	Reg_{temp}	$-40^\circ > T_a > +85^\circ\text{C}$	—	± 0.8	—	$\%V_o$
Line Regulation	Reg_{line}	Over V_{in} range	—	± 2	—	mV
Load Regulation	Reg_{load}	Over I_o range	—	± 1	—	mV
Total Output Voltage Variation	$\Delta V_{o\text{tot}}$	Includes set-point, line, load, $-40^\circ > T_a > +85^\circ\text{C}$	—	± 1.6	± 3	$\%V_o$
Efficiency	η		—	91	—	%
V_o Ripple (pk-pk)	V_r	20MHz bandwidth	—	70	—	mV _{pp}
Transient Response	t_{tr}	1A/ μs load step, 50% to 100% $I_{o\text{max}}$	—	75	—	μs
	ΔV_{tr}	V_o over/undershoot	—	± 2	—	$\%V_o$
Over-Current Threshold	I_{TRIP}	Shutdown, followed by auto-recovery	—	23	—	A
Output Over-Voltage Protection	OVP	Output shutdown and latch off	—	125	—	$\%V_o$
Switching Frequency	f_o	Over V_{in} range	—	300	—	kHz
Under-Voltage Lockout	UVLO		—	32	—	V
Remote On/Off Input		Referenced to $-V_{in}$				
Input High Voltage	V_{IH}		4.5	—	Open (2)	V
Input Low Voltage	V_{IL}		-0.2	—	+0.8	V
Input Low Current	I_{IL}		—	-0.3	—	mA
Standby Input Current	$I_{in\text{ standby}}$	pins 1 & 2 connected	—	2	—	mA
Internal Input Capacitance	C_{in}		—	1.4	—	μF
External Output Capacitance	C_{out}	Between $+V_o$ and $-V_o$	0	—	5,000	μF
Isolation Voltage		Input-output & input-case	1500	—	—	V _{dc}
Capacitance		Input-output	—	1200	—	pF
Resistance		Input-output	10	—	—	M Ω

Notes: (1) If (-) Remote Sense is not used, pin 12 must be connected to pin 13 for optimum output voltage accuracy.

(2) The Remote On/Off input has an internal pull-up. If it is left open-circuit the module will operate when input power is applied. A discrete MOSFET or bipolar transistor is recommended to control this input. The open-circuit voltage is typically 5V. See application notes for interface considerations.

PT4403 Characteristic Data

Efficiency vs Load Current; $V_o = 5\text{V}$ (See Note A)

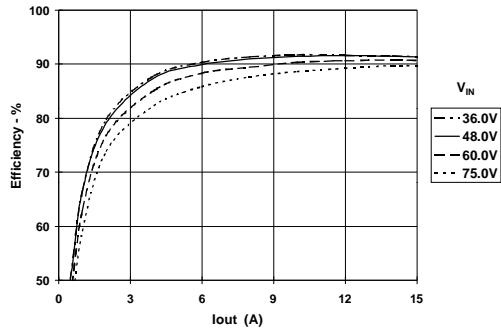

Power Dissipation vs Load Current; $V_o = 5\text{V}$ (See Note A)

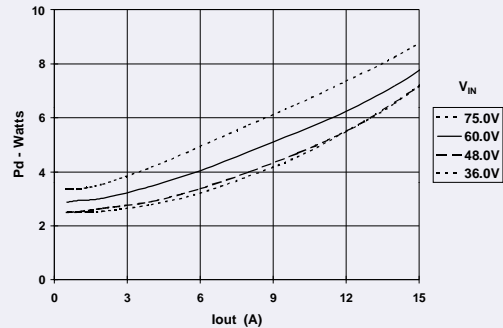

Output Ripple vs Load Current; $V_o = 5\text{V}$ (See Note A)

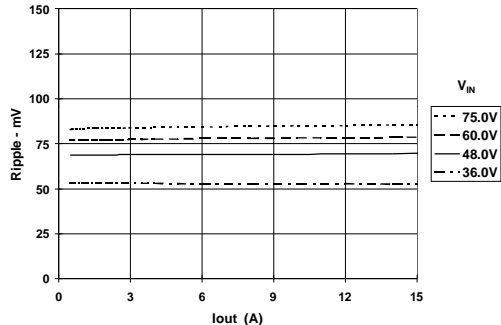

Safe Operating Area; $V_{in} = 48\text{V}$ (See Note B)

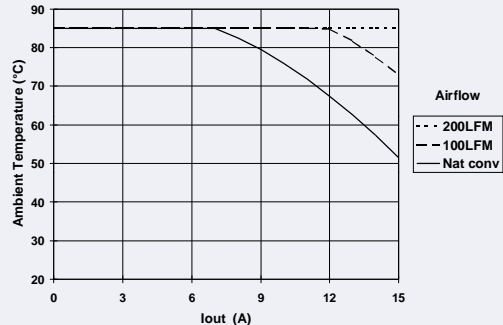

Note A: All data listed in the above graphs has been developed from actual products tested at 25°C . This data is considered typical data for the DC-DC Converter.

Note B: SOA curves represent operating conditions at which internal components are at or below manufacturer's maximum rated operating temperature.

Operating Features and System Considerations for the PT4400 Series of Isolated DC/DC Converters

Over-Current Protection

To protect against load faults, the PT4400 series incorporates output over-current protection. Applying a load that exceeds the converter's over-current threshold (see applicable specification) will cause the regulated output to momentarily fold back and shut down. Following shutdown the module will periodically attempt to automatically recover by initiating a soft-start power-up. This is often described as a "hiccup" mode of operation, whereby the module continues in the cycle of successive shutdown and power up until the load fault is removed. Once the fault is removed, the converter then automatically recovers and returns to normal operation.

Output Over-Voltage Protection

The PT4400 DC/DC converter series incorporates protection circuitry that continually senses for an output overvoltage (OV) condition. The OV threshold automatically tracks the VID output voltage program setting to a level that is 25% higher than that programmed at the control pins, VID0 through VID4. If the converter output voltage exceeds this OV threshold, the converter is immediately shut down and remains in a latched-off state. In order to resume normal operation the converter must be actively reset. This can only be done by momentarily removing the input power to the converter. For failsafe operation and redundancy, the OV protection uses circuitry that is independent of the converter's internal feedback loop.

Over-Temperature Protection

Over-temperature protection is provided by an internal temperature sensor, which closely monitors the temperature of the converter's metal case. If the case temperature exceeds a nominal 115°C, the converter will shut down. The converter will then automatically restart when the sensed temperature drops back to approximately 105°C. When operated outside its recommended thermal derating envelope (see data sheet SOA curves), the converter will typically cycle on and off at intervals from a few seconds to one or two minutes. This is to ensure that the internal components are not permanently damaged from excessive thermal stress.

Under-Voltage Lockout

The Under-Voltage Lock-Out (UVLO) is designed to prevent the operation of the converter until the input voltage is close to the minimum input voltage. The converter is held off when the input voltage is below the UVLO threshold, and turns on when the input voltage

risers above the threshold. This prevents high start-up current during normal power-up of the converter, and minimizes the current drain from the input source during low input voltage conditions. The converter will meet full specifications when the minimum specified input voltage is reached. The UVLO circuitry also overrides the operation of the *Remote On/Off* control. Only when the input voltage is above the UVLO threshold will the *Remote On/Off* control be functional.

Primary-Secondary Isolation

The PT4400 DC/DC converter series incorporates electrical isolation between the input terminals (primary) and the output terminals (secondary). All converters are production tested to a withstand voltage of 1500VDC. This specification complies with UL60950 and EN60950 and the requirements for operational isolation. This allows the converter to be configured for either a positive or negative input voltage source. The data sheet 'Pin Descriptions' section provides guidance as to the correct reference that must be used for the external control signals.

Fuse Recommendations

If desired, an input fuse may be added to protect against the application of a reverse input voltage.

Thermal Considerations

Airflow may be necessary to ensure that the module can supply the desired load current in environments with elevated ambient temperatures. The required airflow rate may be determined from the Safe Operating Area (SOA) thermal derating chart (see converter specifications). The recommended direction for airflow is into, or perpendicular to, the longest side of the module's metal case. See Figure 1.

Figure 1

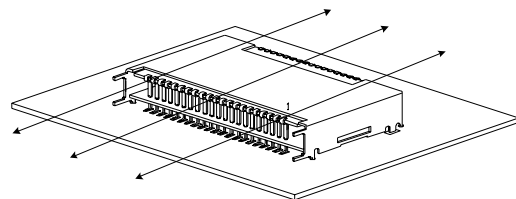

Recommended direction for airflow is into (perpendicular to) the longest side.

Using the Remote On/Off Function on the PT4400 Series of Isolated DC/DC Converters

For applications requiring output voltage On/Off control, the PT4400 DC/DC converter series incorporates a “Remote On/Off” control (pin 1). This feature can be used to switch the module off without removing the applied input source voltage.

The converter functions normally with Pin 1 open-circuit, providing a regulated output voltage when a valid source voltage is applied to +V_{in} (pins 4, 5), with respect to -V_{in} (pins 2, 3). When a low-level 1 ground signal is applied to pin 1, the converter output will be turned off.

Figure 1 is an application schematic, which shows the typical use of the Remote On/Off function. Note the discrete transistor (Q₁). The Remote On/Off pin has its own internal pull-up, allowing it to be controlled with an open-collector or open-drain device (See notes 2 & 3). Table 1 gives the threshold requirements.

When placed in the “Off” state, the standby current drawn from the input source is typically reduced to less than 1mA.

Table 1; Pin 1 Remote On/Off Control Requirements ¹

Parameter	Min	Typ	Max
Enable (V _{IH})	4.5V	—	—
Disable (V _{IL})	—	—	0.8V
V _{O/c} [Open-Circuit]	—	5.0V	—
I _{in} [pin 1 at -V _{in}]	—	—	-0.5mA

Notes:

1. The Remote On/Off control uses -V_{in} (pins 2, 3) as its ground reference. All voltages are with respect to -V_{in}.
2. Use an open-collector device (preferably a discrete transistor) for the Remote On/Off input. A pull-up resistor is not necessary. To disable the output voltage, the control pin should be pulled low to less than +0.8V.
3. The Remote On/Off pin may be controlled with devices that have a totem-pole output. This is provided the output high-level voltage (V_{OH}) meets the module’s minimum V_{IH} specified in Table 1. *Do not* apply more than +20V. If a TTL gate is used, a pull-up resistor may be required to the logic supply voltage.
4. The PT4400 converters incorporate an “Under-Voltage Lockout” (UVLO). The UVLO keeps the converter off until the input voltage is close to the minimum specified operating voltage. This is regardless of the state of the Remote On/Off control. Table 2 gives the UVLO input voltage thresholds.

Table 2; UVLO Thresholds ⁴

Series	V _{in} Range	UVLO Threshold
PT4400	36–75V	32V ±2V

Figure 1

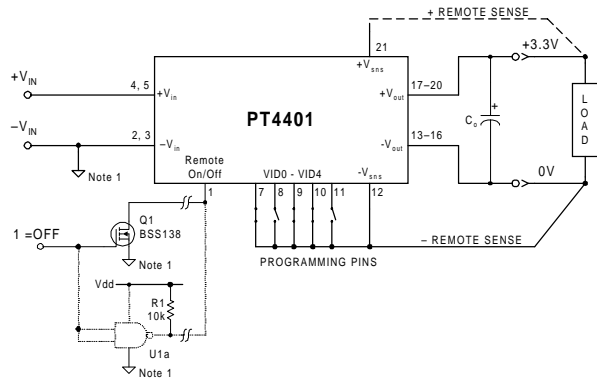

Turn-On Time: In the circuit of Figure 1, turning Q₁ on applies a low-voltage to pin 1 and disables the converter output. Correspondingly, turning Q₁ off allows pin 1 to be pulled high by an internal pull-up resistor. The converter produces a regulated output voltage within 50ms. Figure 2 shows the output response of a PT4401 following the turn-off of Q₁. The turn off of Q₁ corresponds to the drop in Q₁ V_{gs}. Although the rise-time of the output voltage is short (<5ms), the indicated delay time will vary depending upon the input voltage and the module’s internal timing. The output voltage of the PT4401 was set to 3.3V by connecting VID0 (pin 7), VID2 (pin 9), and VID3 (pin 10) to the (-)Remote Sense (pin 12). The waveforms were measured with 48VDC input voltage, and a 10A resistive load.

Figure 2

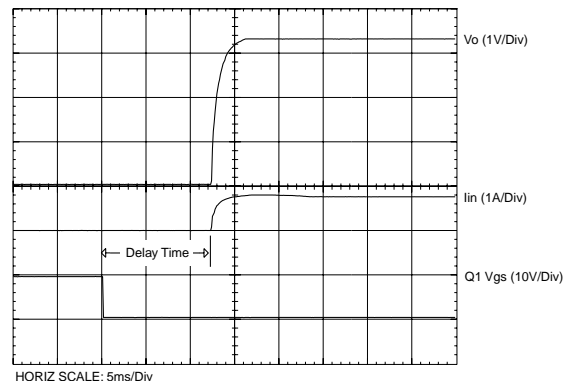

Pin-Coded Output Voltage Adjustment on the PT4400 Programmable DC/DC Converters

The PT4400 series of isolated DC/DC converters have a programmable output voltage. In each case the desired output voltage must be selected from one of a number of discrete voltages using the voltage programming control pins. Depending on each model's resolution and adjustment range, there are up to five control pins. They are identified VID0–VID4 (pins 7–11) respectively. By selectively strapping these control pins to (–)Remote Sense (pin 12), the output voltage can be programmed in incremental steps over the defined output voltage range. The program code and output voltage range of the PT4401 is also compatible with the “Voltage ID” code defined in the Intel® VRM 8.2 specification. Refer to Figure 1 for the connection schematic, and the product specification sheet for each model's applicable program code.

Notes:

- The programming convention is as follows:-
 Logic 0: Connect to pin 12 (–Remote Sense).
 Logic 1: Open circuit/open drain (See notes 2, & 4)
- Do not connect pull-up resistors to the voltage programming pins.
- To minimize output voltage error, always use pin 12 (–Remote Sense) as the logic “0” reference. While $-V_{out}$ (pins 13–16) can also be used for programming, doing so will degrade the voltage selection accuracy and load regulation of the product.
- When VID0–VID4 are all open circuit (logic 1), the output voltage is undefined. In this state the output voltage of the converter cannot be guaranteed, and can vary with output load and input voltage.

- On all models other than the PT4401, the control input VID4 (pin 11) is internally disabled and not functional.
- If active devices are used to ground the voltage control pins, low-level open drain MOSFET devices should be used over bipolar transistors. The inherent $V_{ce(sat)}$ in bipolar devices introduces errors in the device's internal voltage control circuit. Discrete transistors such as the BSS138 or IRLML2402 are examples of appropriate devices.

Active Voltage Programming:

Special precautions should be taken when making changes to the voltage program code while the output is active. This activity induces a transient, which may activate the module's output over-voltage (OV) protection. Once triggered the OV protection circuit latches the output off, and requires the momentary removal of input power to reset the module. OV protection trips can be avoided by limiting the output voltage adjustment to no more than a 15% change from the initial voltage. Large transitions are best made with a series of incremental changes, allowing 100 μ s settling time between each program state. When using active devices to program the output voltage, their state should be asserted prior to input power being applied. An alternative is to pull pin 1 (Remote On/Off) to $-V_{in}$ (pins 2, 3) during the application of power, assert the required program code, and then release pin 1. The module will then initiate a soft-start power-up to the desired program voltage.

Figure 1

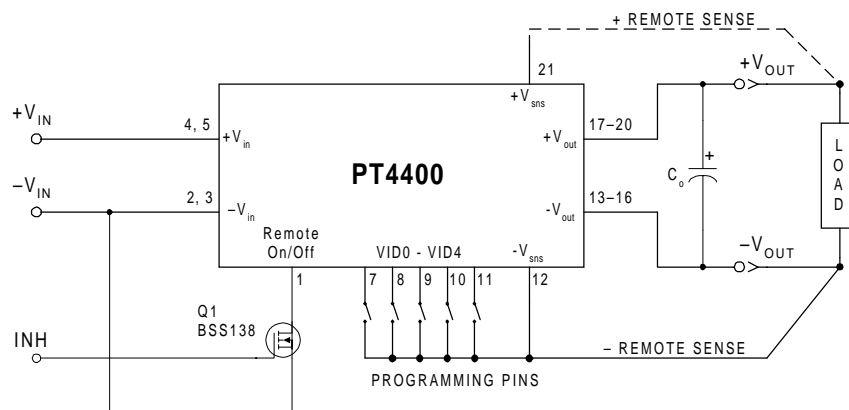

IMPORTANT NOTICE

Texas Instruments Incorporated and its subsidiaries (TI) reserve the right to make corrections, modifications, enhancements, improvements, and other changes to its products and services at any time and to discontinue any product or service without notice. Customers should obtain the latest relevant information before placing orders and should verify that such information is current and complete. All products are sold subject to TI's terms and conditions of sale supplied at the time of order acknowledgment.

TI warrants performance of its hardware products to the specifications applicable at the time of sale in accordance with TI's standard warranty. Testing and other quality control techniques are used to the extent TI deems necessary to support this warranty. Except where mandated by government requirements, testing of all parameters of each product is not necessarily performed.

TI assumes no liability for applications assistance or customer product design. Customers are responsible for their products and applications using TI components. To minimize the risks associated with customer products and applications, customers should provide adequate design and operating safeguards.

TI does not warrant or represent that any license, either express or implied, is granted under any TI patent right, copyright, mask work right, or other TI intellectual property right relating to any combination, machine, or process in which TI products or services are used. Information published by TI regarding third-party products or services does not constitute a license from TI to use such products or services or a warranty or endorsement thereof. Use of such information may require a license from a third party under the patents or other intellectual property of the third party, or a license from TI under the patents or other intellectual property of TI.

Reproduction of information in TI data books or data sheets is permissible only if reproduction is without alteration and is accompanied by all associated warranties, conditions, limitations, and notices. Reproduction of this information with alteration is an unfair and deceptive business practice. TI is not responsible or liable for such altered documentation.

Resale of TI products or services with statements different from or beyond the parameters stated by TI for that product or service voids all express and any implied warranties for the associated TI product or service and is an unfair and deceptive business practice. TI is not responsible or liable for any such statements.

Mailing Address:

Texas Instruments
Post Office Box 655303
Dallas, Texas 75265