

# ESTF15SS120S/C/E

Fast Recovery Diode

## Features

- Repetitive Reverse Voltage :  $V_{RRM} = 1200V$
- Forward Voltage Drop :  $V_F(\text{typ.}) = 3.2V$
- Average Forward Current :  $I_{F(AV.)} = 15A @ T_c = 100^\circ C$
- Fast Reverse Recovery Time :  $t_{rr}(\text{typ.}) = 75ns$
- RoHS product

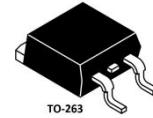

ESF15SS120E

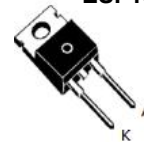

TO-220C



TO-247

ESF15SS120C

ESF15SS120S

## Applications

- Switching Power Supplies
- Power Switching Circuits
- General Purpose
- UPS



## Absolute Maximum Ratings @ $T_c=25^\circ C$

Symbol	Parameter	ratings	Unit
$V_{RRM}$	Repetitive peak reverse voltage @ $50\mu A$	1200	V
$V_{RWM}$	Working Peak Reverse Voltage	1200	V
$V_R$	DC Blocking Voltage	1200	V
$I_{F(AV)}$	Average forward current @ $T_c=100^\circ C$	15	A
$I_{FRM}$	Repetitive Peak Surge Current	30	A
$I_{FSM}$	Peak one Cycle Surge Forward @ $t=10ms$	200	A
$P_D$	Maximum Power Dissipation	100	W
$E_{AVL}$	Avalanche Energy(See Figures 10 and 11)	20	mJ
$T_j$	Junction Temperature	-65~+175	$^\circ C$
$T_{STG}$	Storage temperature range	-65~+175	$^\circ C$

## Electrical Specifications @ $T_c=25^\circ C$

Symbol	Parameter		Ratings			Unit
			Min	Typ	Max	
$I_R$	$T_j=25^\circ C$	$V_R=V_{RRM}$			100	$\mu A$
	$T_j=125^\circ C$				500	$\mu A$
$V_F$	$T_j=25^\circ C$	$I_F=15A$		2.2	3.2	V
	$T_j=125^\circ C$				2.6	V
$T_{rr}$	$I_F=1A, diF/dt=100A/\mu s$				65	ns
	$I_F=15A, diF/dt=100A/\mu s$				75	ns

$t_a$	$I_F=15A, di_F/dt=100A/\mu s$		36		ns
$t_b$	$I_F=15A, di_F/dt=100A/\mu s$		28		ns
$Q_{rr}$	$I_F=15A, di_F/dt=100A/\mu s$		150		nC
$C_J$	$V_R=10V, I_F=0A$		55		pF
$R_{th(j-c)}$	Thermal resistance from junction to case	TO-247-2L		0.9	$^{\circ}C/W$
$R_{th(j-c)}$		TO-220C-2L		1.5	$^{\circ}C/W$
$R_{th(j-c)}$		TO-263		0.8	$^{\circ}C/W$

## Order Information

Order codes	Silkscreen	Package	Packaging
ESTF15SS120C	F15S120C	TO-220C-2L	
ESTF15SS120S	F15S120S	TO-247-2L	
ESTF15SS120E	F15S120E	TO-263	

## Test Circuits and Waveform

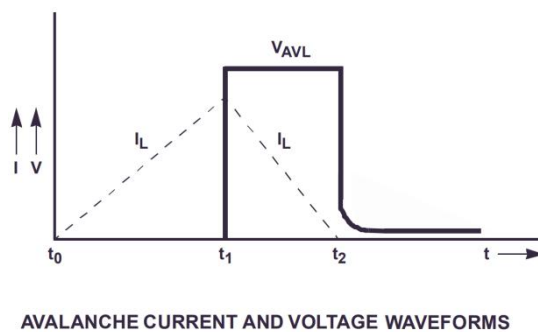
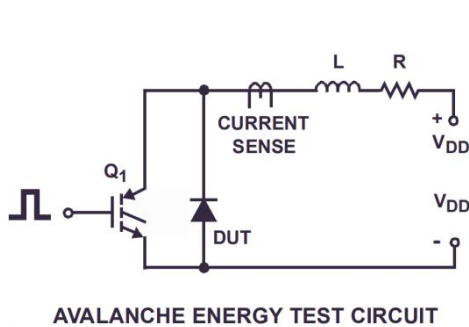
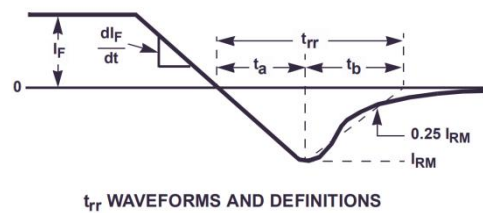
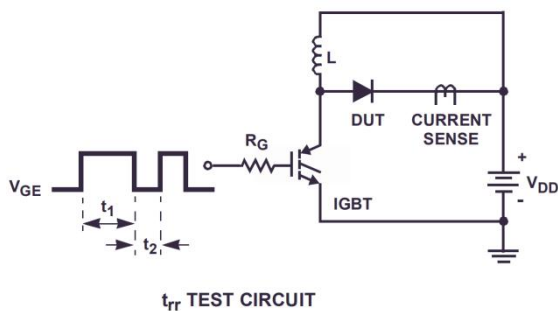

## Typical Performance Curves

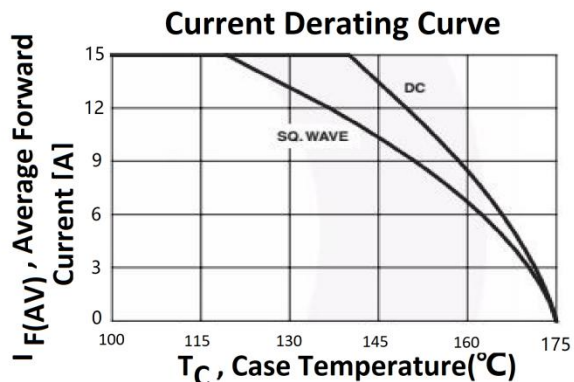
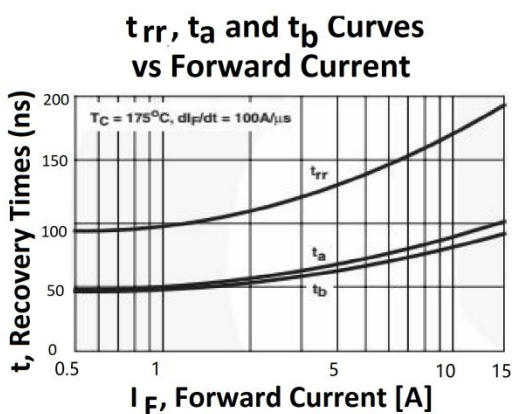
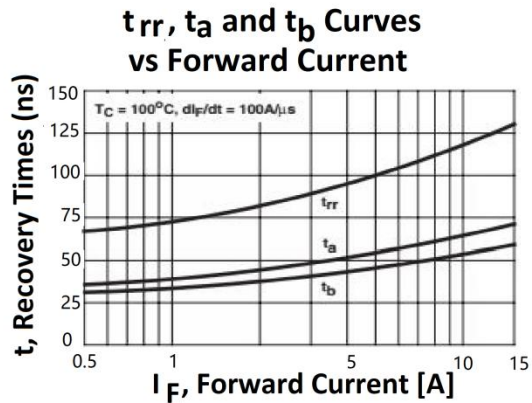
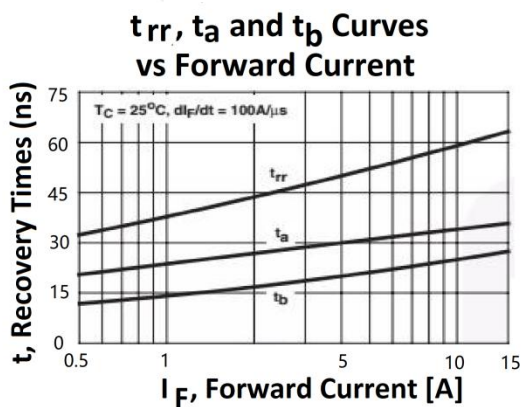
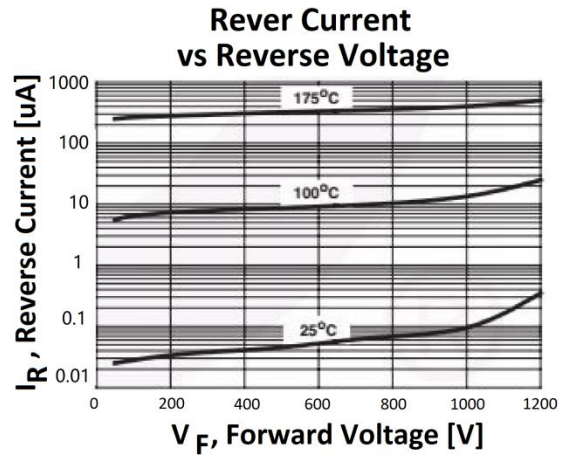
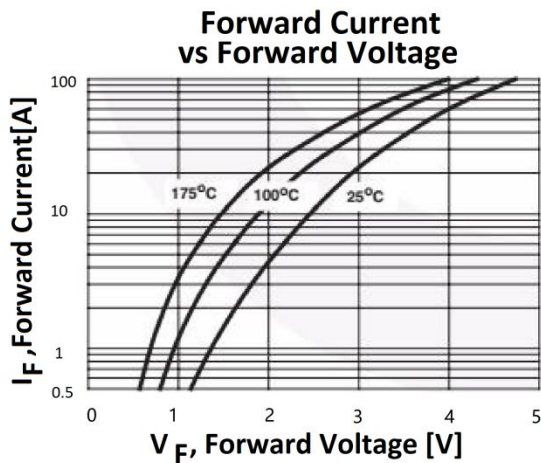

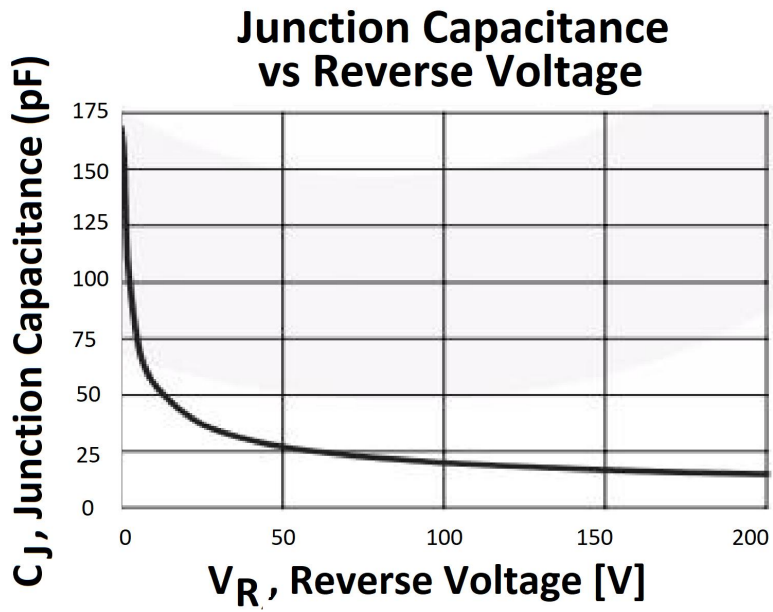

## Package

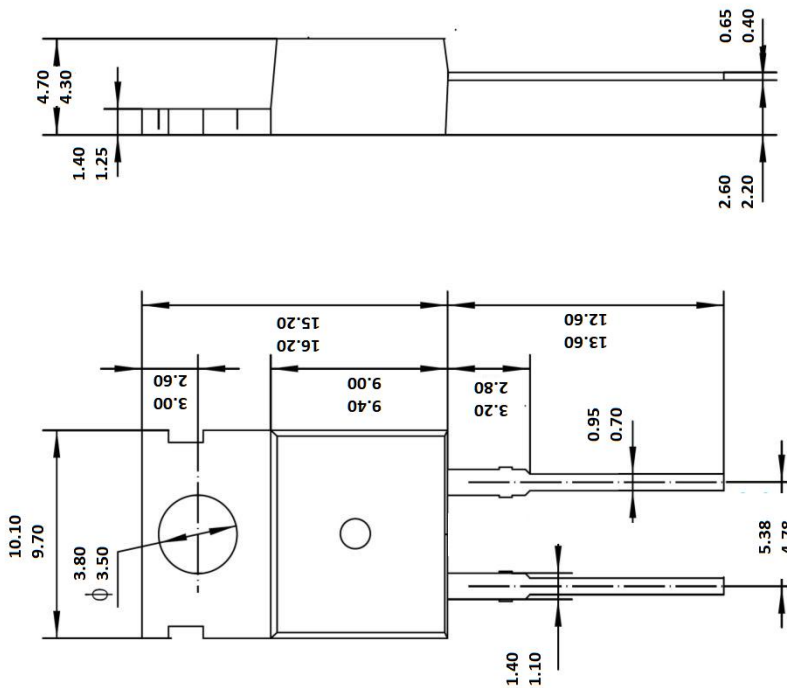

**TO-220C-2L** Unit: mm

