

# ***bq30z554EVM SBS 1.1 Impedance Track™ Enabled Battery Management Solution EVM***

The bq30z554EVM is a complete evaluation system for the bq30z554/bq29412 battery management solution. This system includes one bq30z554/bq29412 circuit module, a current sense resistor, two thermistors, and a link to Windows®-based PC software.

The circuit module includes one bq30z554 IC, one bq29412 IC, and all other onboard components necessary to monitor and predict capacity, perform cell balancing, monitor critical parameters, protect the cells from overcharge, overdischarge, short circuit, and overcurrent in 2-series, 3-series, or 4-series cell Li-Ion or Li-Polymer battery packs. The circuit module connects directly across the cells in a battery.

With the EV2300 or EV2400 interface board and software, users can read the bq30z554 data registers, program the chipset for different pack configurations, log cycling data for further evaluation, and evaluate the overall functionality of the bq30z554/bq29412 solution under different charge and discharge conditions.

### Contents

1	Features .....	2
2	bq30z554 Device-Based Circuit Module .....	2
3	bq30z554 Circuit Module .....	3
4	Circuit Module Physical Layouts, Schematic and Bill of Materials .....	3
5	EVM Hardware and Software Setup .....	10
6	Troubleshooting Unexpected Dialog Boxes .....	10
7	Hardware Connection .....	10
8	Operation .....	12
9	Calibration Screen .....	15
10	Pro (Advanced) Screen .....	17
11	Seal/Authentication Screen .....	19
12	bqChem .....	20
13	Related Documentation from Texas Instruments .....	21

### List of Figures

1	bq30z554EVM Layout (Silkscreen) .....	4
2	Top Assembly .....	4
3	Top Layer .....	5
4	Inner Layer 1 .....	5
5	Inner Layer 2 .....	5
6	Bottom Layer .....	6
7	Bottom Assembly .....	6
8	Schematic .....	7
9	bq30z554 Circuit Module Connection to Cells and System Load/Charger .....	11
10	SBS Data Screen .....	13
11	Data Flash Screen, First-Level Safety Class .....	14
12	Calibration Screen .....	16
13	Pro (Advanced) Screen .....	18

Windows is a registered trademark of Microsoft Corporation.

14	Seal/Authentication Screen .....	19
15	bqChem Screen .....	20

**List of Tables**

1	Ordering Information .....	2
2	Bill of Materials .....	8
3	Performance Specification Summary .....	10
4	Circuit Module to EV2300 or EV2400 Connections.....	11

## 1 Features

- Complete evaluation system for the bq30z554 SBS 1.1-Compliant Advanced Gas Gauge with Impedance Track™ technology, bq30z554 and bq29412 independent overvoltage protection integrated circuit (IC)
- Populated circuit module for quick setup
- Link to software that allows data logging for system analysis

### 1.1 Kit Contents

- bq30z554/bq29412 circuit module
- Links to support documentation

### 1.2 Ordering Information

**Table 1. Ordering Information**

EVM PART NUMBER	CHEMISTRY	CONFIGURATION	CAPACITY
bq30z55EVM (PWR194)	Li-Ion	2-series, 3-series, or 4-series cell	Any

## 2 bq30z554 Device-Based Circuit Module

The bq30z554/bq29412-based circuit module is a complete and compact example solution of a bq30z554 circuit for battery management and protection of Li-Ion or Li-Polymer packs. The circuit module incorporates a bq30z554 battery monitor IC, bq29412 independent overvoltage protection IC, and all other components necessary to accurately predict the capacity of 2-series, 3-series, or 4-series cells.

### 2.1 Circuit Module Connections

Contacts on the circuit module provide the following connections:

- Direct connection to the cells: 1N (BAT–), 1P, 2P, 3P, 4P (BAT+)
- To the serial communications port (SMBC, SMBD, VSS)
- The system load and charger connect across PACK+ and PACK–
- To the system present pin (SYS PRES)

## 2.2 Pin Descriptions

PIN NAME	DESCRIPTION
1N	–ve connection of first (bottom) cell
1P	+ve connection of first (bottom) cell
2P	+ve connection of second cell
3P	+ve connection of third cell
4P	+ve connection of fourth (top) cell
SMBC	Serial communication port clock
SMBD	Serial communication data port
VSS	Pack negative terminal
PACK–	Pack negative terminal
SYS PRES	System present pin (if low, system is present)
PACK+	Pack positive terminal

## 3 bq30z554 Circuit Module

This section contains information on configuration and fuse-blowing tests for the bq30z554/bq29412 implementation.

### 3.1 Choosing Particular Precharge Mode

The bq30z554 contains an internal precharge FET; however, the default firmware configuration uses the Charge FET for precharge. To evaluate the internal precharge FET, change the least two significant bits in DF:Configuration:Charging Configuration to be 0,0. See the *bq30z5x-R1 Technical Reference Manual (SLUU852)* for additional information.

### 3.2 Testing Fuse-Blowing Circuit

To prevent the loss of board functionality during the fuse-blowing test, the actual chemical fuse is not provided in the circuit. FET Q1 drives TP8 low if a fuse-blow condition occurs; monitoring TP8 can be used to test this condition.

---

**NOTE:** Pull up TP8 to test the fuse circuit.

---

## 4 Circuit Module Physical Layouts, Schematic and Bill of Materials

This section contains the board layout, assembly drawings, schematic, and bill of materials for the bq30z554/bq29412 circuit module.

### 4.1 Board Layout

This section shows the dimensions, PCB layers, and assembly drawing for the bq30z554 module.

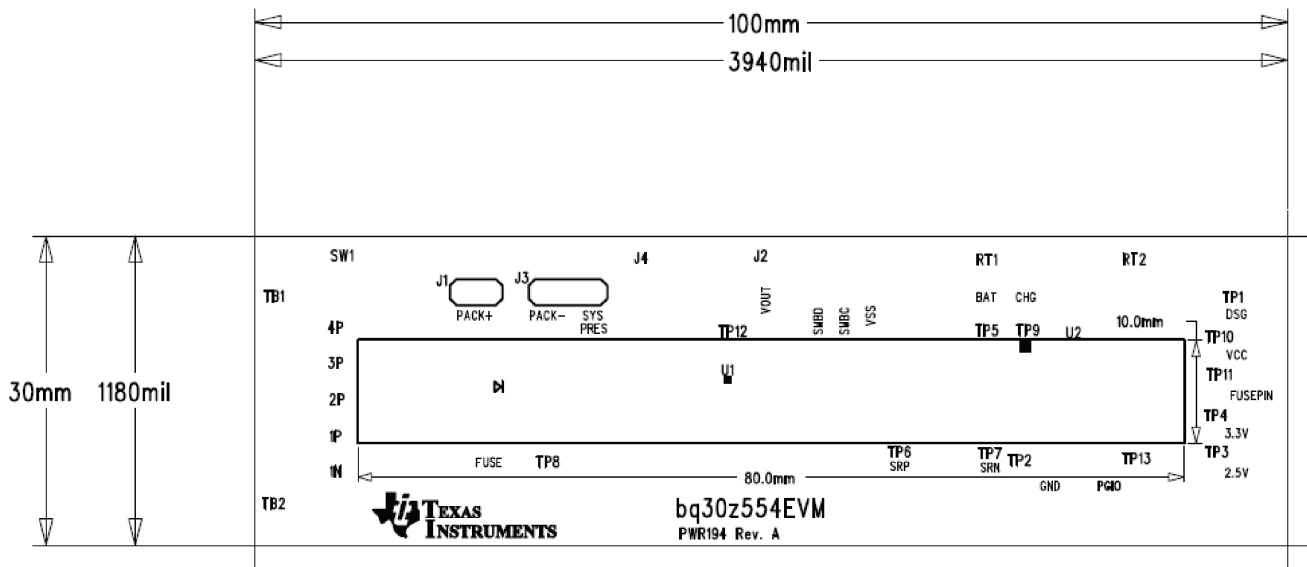

Figure 1. bq30z554EVM Layout (Silkscreen)

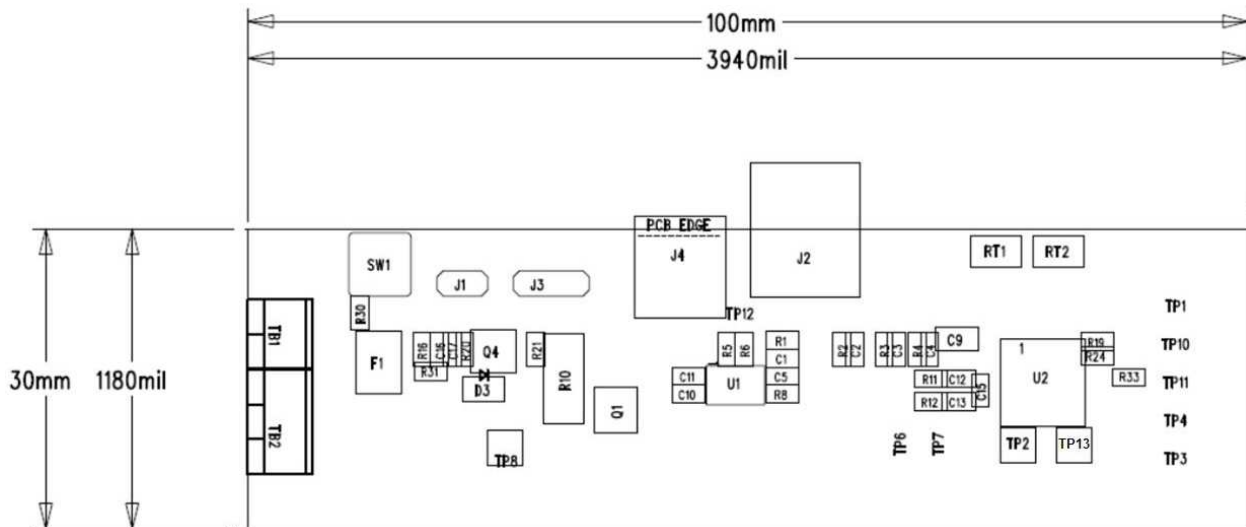

Figure 2. Top Assembly

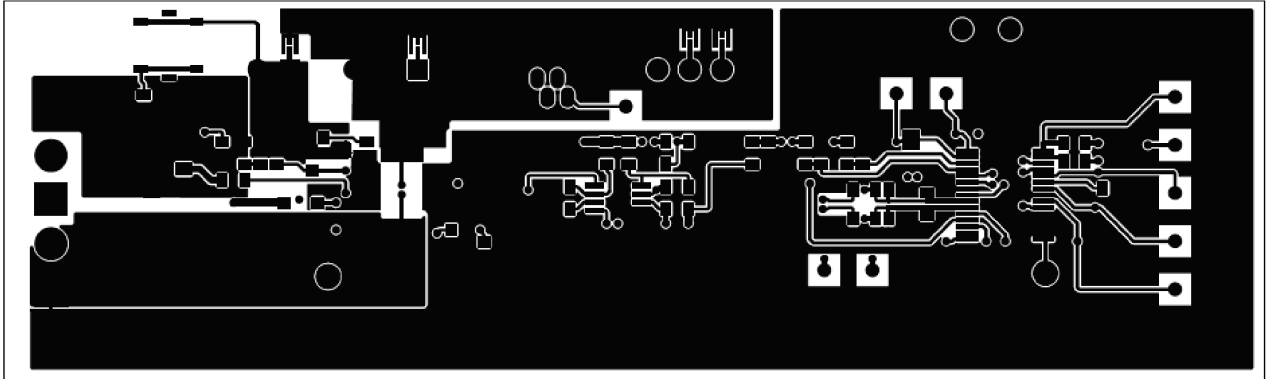

Figure 3. Top Layer

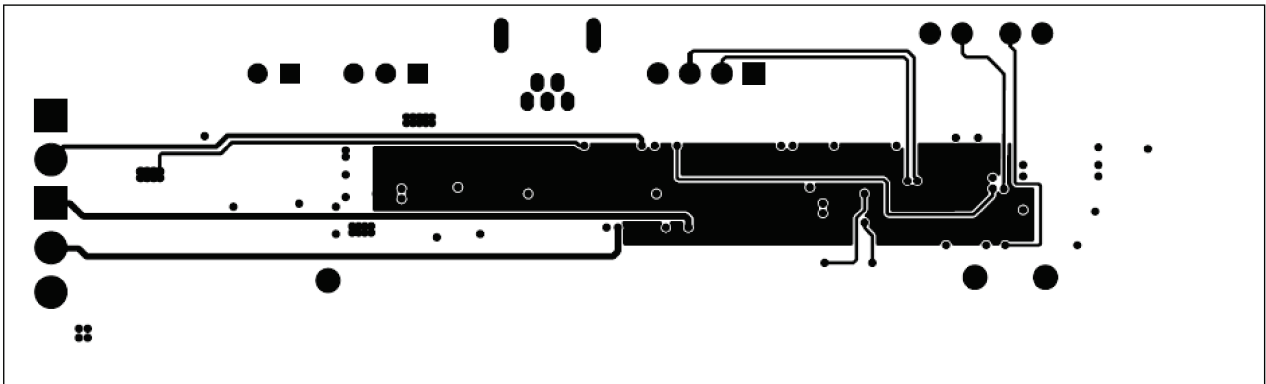

Figure 4. Inner Layer 1

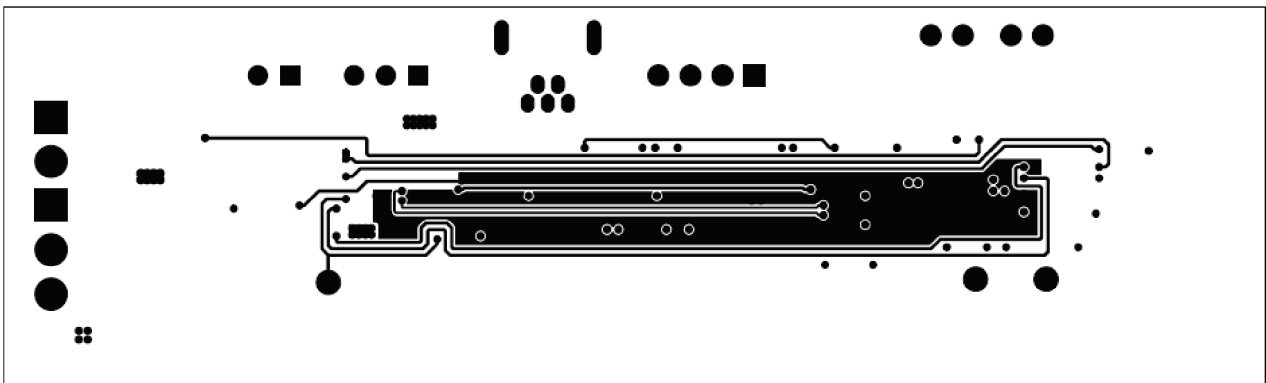

Figure 5. Inner Layer 2



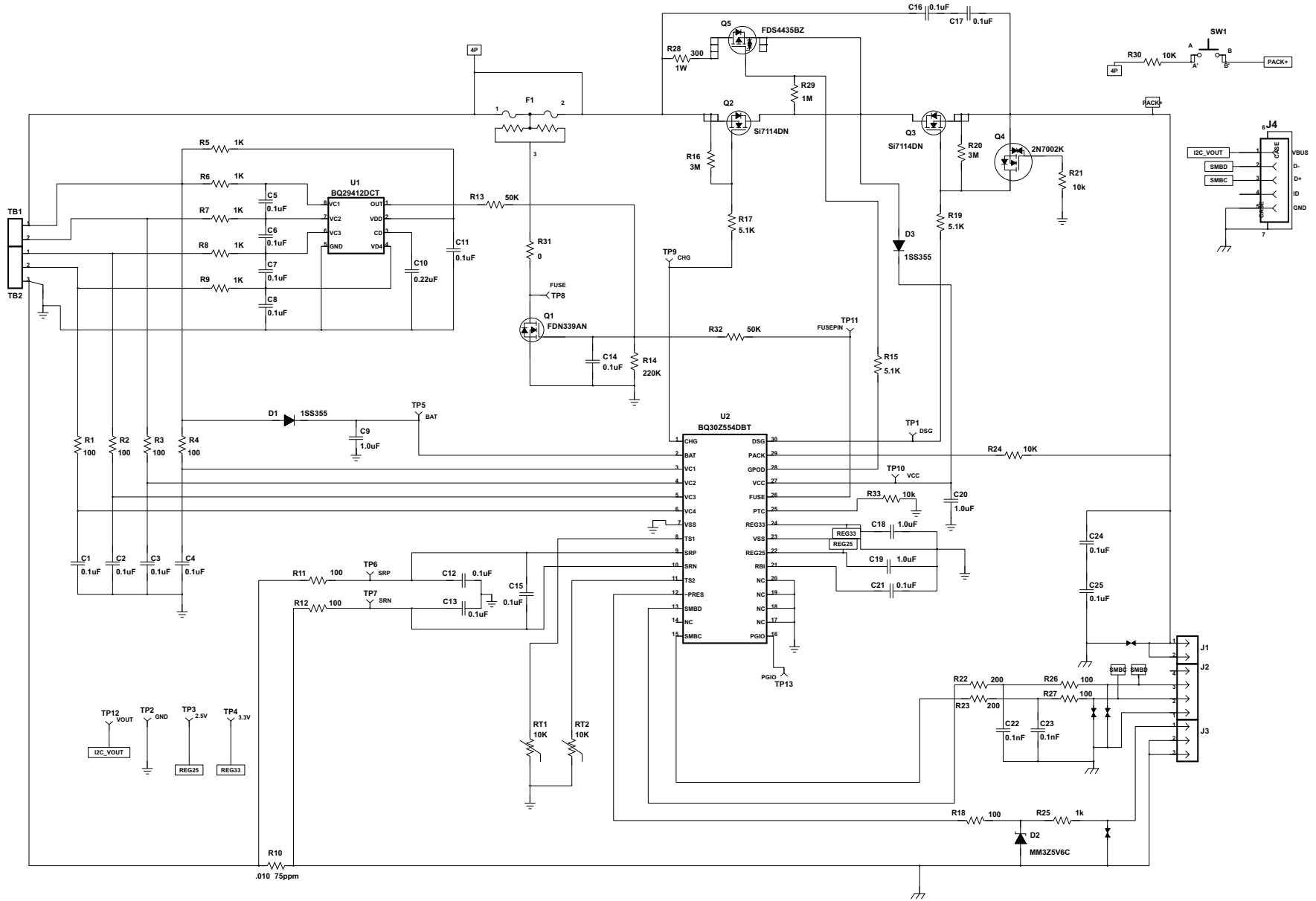

Figure 8. Schematic

## 4.2 Bill of Materials

**Table 2. Bill of Materials**

Count	Reference Design	Value	Description	Size	Part Number	Manufacturer
18	C1-8 C11-17 C21 C24 C25	0.1uF	Capacitor, Ceramic, 50 V, X7R, 20%	0603	Std	Any
4	C9 C18-20	1.0uF	Capacitor, Ceramic, 25 V, X7R, 20%	0805	Std	Any
1	C10	0.22uF	Capacitor, Ceramic, 25 V, X7R, 20%	0603	Std	Any
2	C22 C23	0.1nF	Capacitor, Ceramic, 50 V, X7R, 20%	0603	Std	Any
2	D1 D3	1SS355	Diode, Switching, 90V, 225 mA Ifm, High speed	SOD-323	1SS355TE-17	Rohm
1	D2	MM3Z5V6C	Diode, Zener, 5.6V, 200mw	SOD-323	MM3Z5V6C	Fairchild
0	F1		Fuse, Chemical, Thermal, xxA	SFDxxx		Sony
1	J1	PTC36SAAN	Header, Male 2-pin, 100mil spacing, (36-pin strip)	0.100 inch x 2	PTC36SAAN	Sullins
1	J2	22-05-3041	Header, Friction Lock Ass'y, 4-pin Right Angle,	0.400 x 0.500	22-05-3041	Molex
1	J3	PTC36SAAN	Header, Male 3-pin, 100mil spacing, (36-pin strip)	0.100 inch x 3	PTC36SAAN	Sullins
1	J4	56579-0519	Connector, USB, Mini AB 5-pins	0.354 X 0.307 Inches	56579-0519	Molex
9	R1-4 R11-12 R18 R26-27	100	Resistor, Chip, 1/16-W, 5%	0603	Std	Std
6	R5-9 R25	1K	Resistor, Chip, 1/16-W, 5%	0603	Std	Std
1	R10	.010 75ppm	Resistor, Chip, 0.010 Ohms, 1-W, xx%	2512	WSL2512R0100FEA	Vishay
2	R13 R32	50K	Resistor, Chip, 1/16-W, 5%	0603	Std	Std
1	R14	220K	Resistor, Chip, 1/16-W, 5%	0603	Std	Std
3	R15 R17 R19	5.1K	Resistor, Chip, 1/16-W, 5%	0603	Std	Any
2	R16 R20	3M	Resistor, Chip, 1/16-W, 5%	0603	Std	Std
2	R21 R33	10k	Resistor, Chip, 1/16-W, 5%	0603	Std	Std
2	R22-23	200	Resistor, Chip, 1/16-W, 5%	0603	Std	Std
2	R24 R30	10K	Resistor, Chip, 1/16-W, 5%	0603	Std	Std
1	R28	300	Resistor, Chip, 1W, 5%	2512	Std	Any
1	R29	1M	Resistor, Chip, 1/16W, 5%	0603	Std	Any
1	R31	0	Resistor, Chip, 1/16-W, 5%	0603	Std	Std
1	SW1	EVQ-PLHA15	Switch, Push button, Momentary, 1P1T, 50-mA, 12-V	0.200 x 0.200 inch	EVQ-PLHA15	Panasonic
1	TB1	ED1514	Terminal Block, 2-pin, 6-A, 3.5mm	0.27 x 0.25	ED555/2DS	OST
1	TB2	ED1515	Terminal Block, 3-pin, 6-A, 3.5mm	0.41 x 0.25	ED555/3DS	OST
2	RT1-2	10K	Thermistor, 10K ohms	0.095 X 0.150	"CH25-3H103 or	
103AT-2"	Semitec					
1	TP2	GND	Test Point, White, Thru Hole Color Keyed	0.100 x 0.100 inch	5002	Keystone
1	TP8	FUSE	Test Point, White, Thru Hole Color Keyed	0.100 x 0.100 inch	5002	Keystone
1	TP13	PGIO	Test Point, White, Thru Hole Color Keyed	0.100 x 0.100 inch	5002	Keystone
1	Q1	FDN339AN	MOSFET, N-ch, 20-V, 3A, 0.05-Ohms	SOT23	FDN339AN	Fairchild



**Table 2. Bill of Materials (continued)**

Count	Reference Design	Value	Description	Size	Part Number	Manufacturer
2	Q2-3	Si7114DN	MOSFET, Fast Switching, NChan, 30V, 18.3A, 7.5milliohm	PWRPAK 1212	Si7114DN-T1-E3	Vishay
1	Q4	2N7002K	MOSFET, Nch, 60V, 300 mA, 2-Ohms	SOT23	2N7002K-T1-E3	Vishay
1	Q5	FDS4435BZ	MOSFET, Pch, -30V, -8.8A, 20-milliohm	SO8	FDS4435BZ	Fairchild
1	U1	BQ29412DCT	IC, Voltage Protection for 2, 3, 4 Cell Lion , 2nd Protection, 4.45 v OVP	SSOP-08	BQ29412DCT	TI
1	U2	BQ30Z554DBT	IC, 2-Series, 3-Series, and 4-Series Li-Ion Battery Pack Manager	TSSOP-38	BQ30Z554DBT	TI
1	--		PCB		PWR194	Std

### 4.3 **bq30z554/bq29412 Circuit Module Performance Specification Summary**

This section summarizes the performance specifications of the bq30z554/bq29412 circuit module.

**Table 3. Performance Specification Summary**

Specification	Min	Typ	Max	Units
Input voltage Pack+ to Pack–	5	15	25	V
Charge and discharge current	0	2	7	A

## 5 EVM Hardware and Software Setup

This section describes how to install the bq evaluation software, and how to connect the different components of the EVM.

### 5.1 System Requirements

The bq evaluation software (EVSW) requires Windows 2000, Windows XP, Windows Vista, or Windows 7.

### 5.2 Software Installation

---

**NOTE:** To get the latest software archive, contact the Texas Instruments field representative assigned to work with this device.

---

To install the EVSW, do the following:

1. Save the archive to a temporary directory.
2. Double-click on the executable filename, and follow the installer instructions to complete the EVSW installation.  
If the EV2300 or EV2400 was not previously installed: After EVSW installation, a TI USB DRIVER INSTALLER pops up. Click **Yes** for the agreement message and follow its instructions.
3. Plug the EV2300 or EV2400 into a USB port.

## 6 Troubleshooting Unexpected Dialog Boxes

Users downloading the files must be logged in as the administrator, or must have privileges to install new programs.

The driver is not signed, so the administrator must allow installation of unsigned drivers in the operating system policy.

## 7 Hardware Connection

The bq30z554EVM-001 comprises two hardware components: the bq30z554/bq29412 circuit module and the EV2300 or EV2400 PC interface box.

### 7.1 Connecting the bq30z554/bq29412 Circuit Module to a Battery Pack

Figure 9 shows how to connect the bq30z554/bq29412 circuit module to the cells and system load/charger.

The cells must be connected in the following order:

1. 4-Cell Pack: 1N (BAT–), 1P, 2P, 3P, then 4P (see Section 2.2 for definitions)
2. 3-Cell Pack: 1N (BAT–), 1P, 2P, and then connect 4P and 3P together
3. 2-Cell Pack: 1N (BAT–), 1P, and then connect 4P, 3P, and 2P together

To start charge or discharge test, connect the SYS PRES pin to the Pack– pin to set SYS PRES state. To test sleep mode, disconnect the SYS PRES pin.

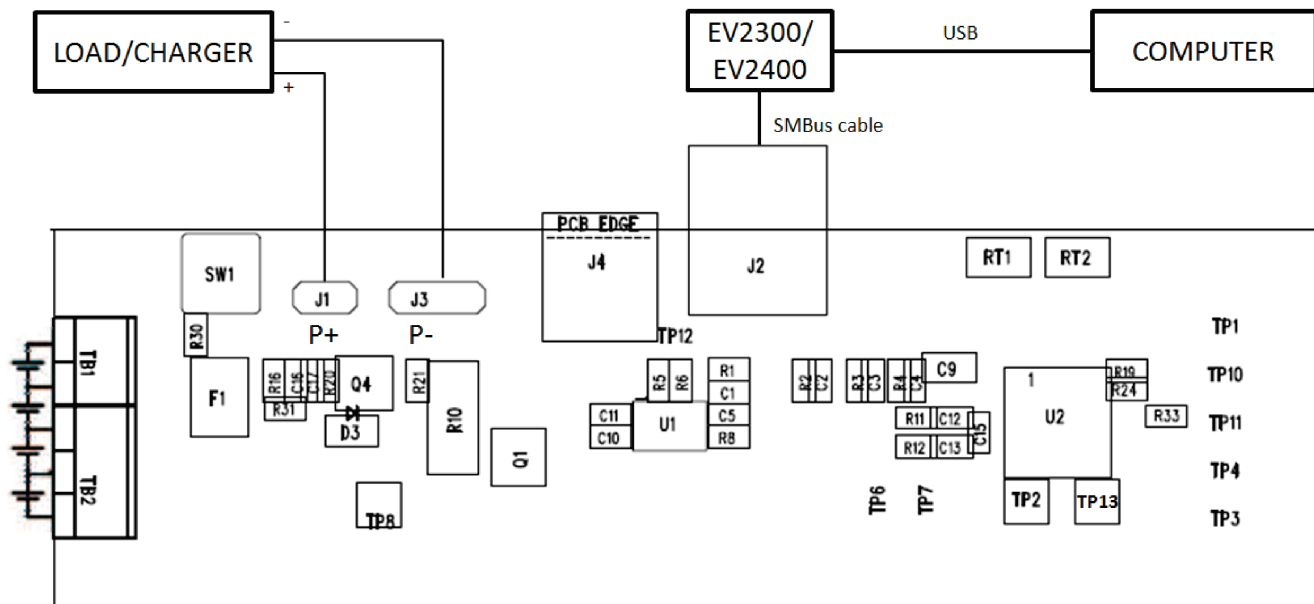

Figure 9. bq30z554 Circuit Module Connection to Cells and System Load/Charger

## 7.2 PC Interface Connection

To configure the hardware to interface to the PC, do the following:

1. Connect the bq30z554 device-based smart battery to the EV2300 or EV2400 using the provided cable or the connections shown in [Table 4](#).

Table 4. Circuit Module to EV2300 or EV2400 Connections

bq30z554 Device-Based Battery	EV2300 or EV2400
SMBD	SMBD
SMBC	SMBC
VSS	GND

2. Connect the PC USB cable to the EV2300 or EV2400 and the PC USB port.

The bq30z554EVM-001 is now set up for operation.

## 8 Operation

This section details the operation of the EVSW.

---

**NOTE:** The EV2300 driver does not support Windows Sleep or Hibernate states. If communicating with the EV2300 or if the EVM presents a problem, unplug the USB cable and then plug it back in. If the problem continues, determine if the EVM is in Shutdown mode. The bq30z554 can be awakened by momentarily pressing SW1 if cell voltage is present.

---

### 8.1 Starting the Program

With the EV2300 or EV2400 and the bq30z554EVM connected to the computer, run the EVSW from the Desktop Icon or **Start | All Programs | Texas Instruments | bq Evaluation Software** menu sequence. The **SBS Data** screen appears. Data begins to appear once the **Refresh** (single time scan) button is clicked, or when the **Keep Scanning** checkbox is checked. To disable the scan feature, deselect **Keep Scanning**.

The continuous scanning period can be set via the **Options** and **Set Scan Interval** menu selections. The range for this interval is 0 ms to 65535 ms. Only items that are selected for scanning are scanned within this period.

The EVSW provides a logging function that logs the values that were last scanned by the EVSW. To enable this function, click the **Start Logging** button; this causes the **Keep Scanning** button to be selected. When logging is *Stopped*, the **Keep Scanning** button is still selected and has to be manually unchecked.

The logging interval is specified under the **Options** menu with the maximum value of 65535 ms. The **Log** interval cannot be smaller than the scan interval because this results in the same value being logged at least twice.

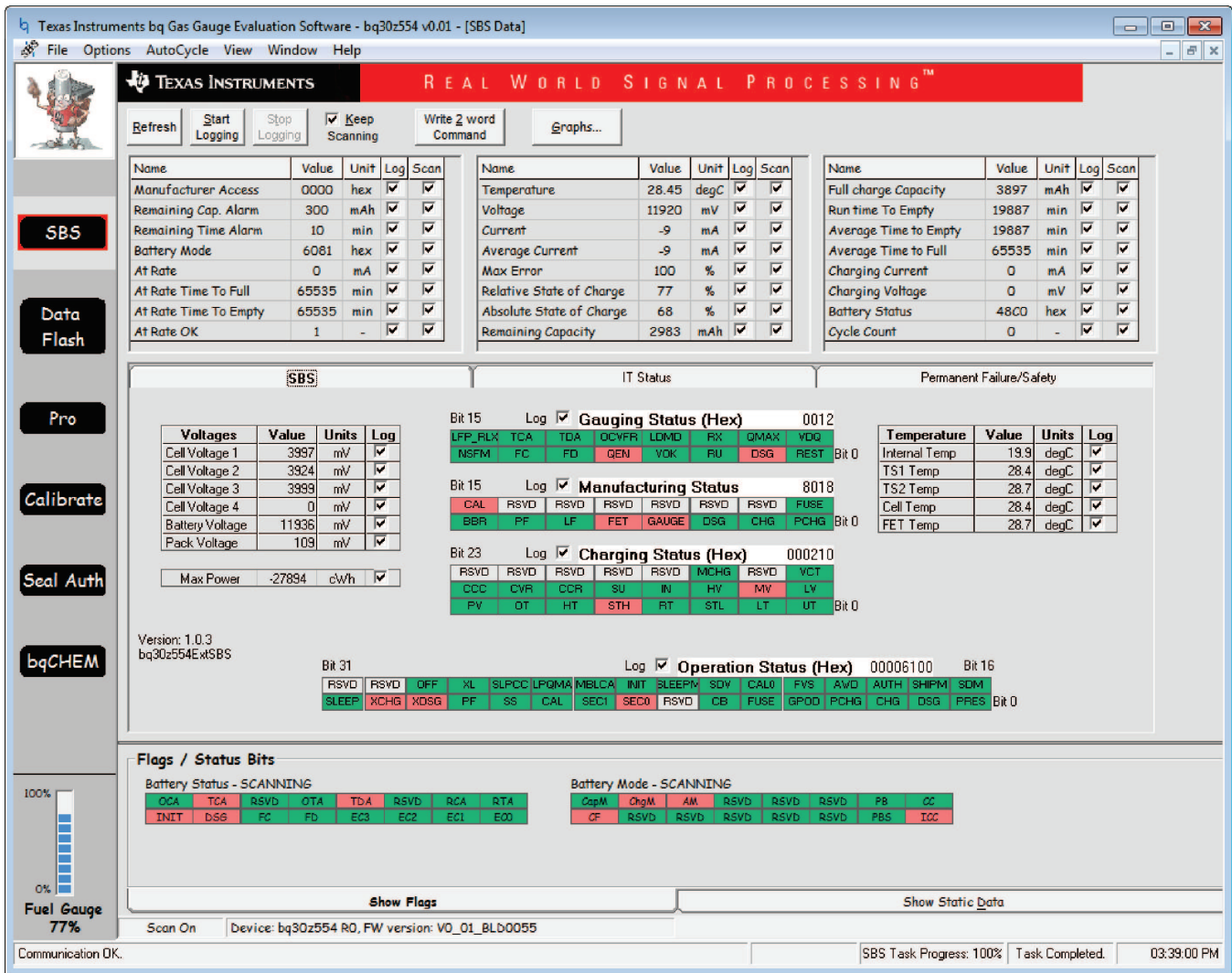

Figure 10. SBS Data Screen

This screen shows the SBS data set along with additional ManufacturersAccess() command information, such as individual cell measurements. Additional Flag and Static data can be viewed by selecting the appropriate tab at the bottom of the SBS screen.

Data such as SBS.ManufacturerName( ) is static and does not change. This data is viewed separately using the **Static Data** tab at the bottom of the screen.

Dragging the splitter bar (the line that separates the Flags/Static data from SBS values) changes the height of the **Flags/Status Bits** display. Selecting **View** then **Auto Arrange** returns the splitter bar to its original location.

## 8.2 Setting Programmable bq30z554 Options

The bq30z554 data flash comes configured per the default settings detailed in the *bq30z554 SBS 1.1-Compliant Gas Gauge With Impedance Track™ Datasheet* (SLUSB29A). Ensure that the settings are correctly changed to match the pack and application for the bq30z554 solution being evaluated.

**IMPORTANT:** To get the best performance, it is essential to correctly set these options.

Use the **Data Flash** screen to configure the settings.

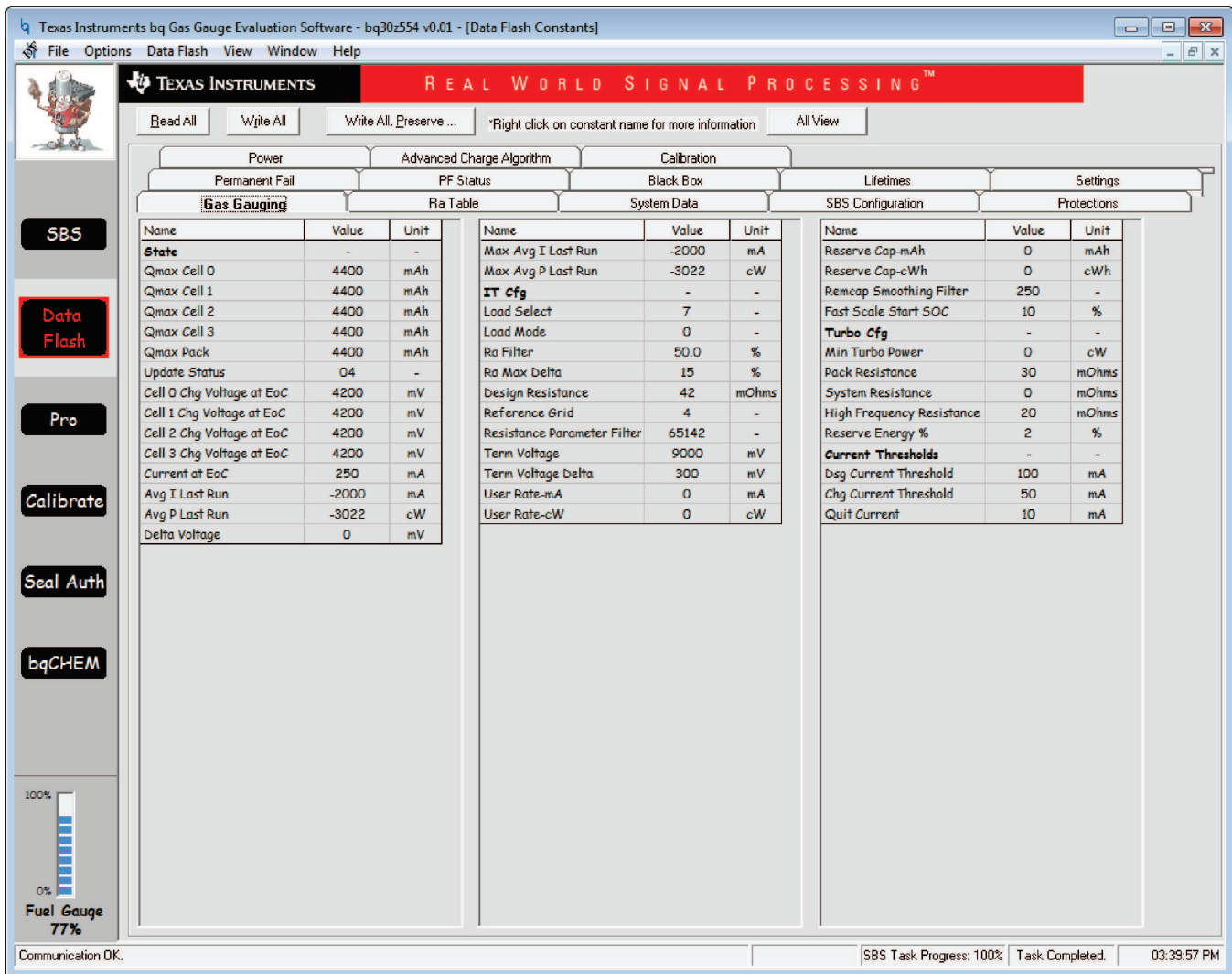

Figure 11. Data Flash Screen, First-Level Safety Class

To read all of the data from the bq30z554 data flash, click on menu option | **Data Flash** | **Read All** |.

To write to a data flash location, click on the desired location, enter the data, and click **Enter**, which writes the entire tab of flash data, or select menu option | **Data Flash** | **Write All** |. The data flash must be read before any writes are performed to avoid any incorrect data being written to the device.

The | **File** | **Special Export** | menu options allows the data flash to be exported.

The data flash configuration can be saved to a file by selecting | **File** | **Export** | and entering a file name. In this way, a data flash file also can be retrieved, imported, and written to the bq30z554 using the **Write All** button. The configuration information of the bq30z554 data is held in the data flash.

The bq30z554 allows for an automatic data flash export function, similar to the **SBS Data logging** function. This feature, when selected via | **Options** | **Auto Export** |, exports data flash to a sequential series of files named as *FilenameNNNNN.gg*, where N = a decimal number from 0 to 9.

The *AutoExport* interval is set under the | **Options** | menu with a minimum value of 15 seconds. The **AutoExport** filename is set under the | **Options** | menu.

When a check is next to | **AutoExport** |, *AutoExport* is in progress. The same menu selection is used to turn *AutoExport* on and off.

If the data flash screen is blank, then the bq30z554 in use may not be supported by the EVSW version in use. An upgrade may be required.

## 9 Calibration Screen

### 9.1 How to Calibrate

The bq30z554 must be calibrated using power supplies, or a power supply and cell simulation resistors (300  $\Omega$  or less) before cells are attached. Before the bq30z554 is calibrated, do the following:

- Connect and measure a 2-A current source from 1N (–) and Pack (–) to calibrate without using the FETs (calibration using the FETs is not recommended).
- Measure each cell voltage.
- Measure the temperature of the pack.
- Whether the foregoing steps are necessary depends on the type of calibration being performed.

### 9.2 Calibrate the bq30z554

To calibrate the bq30z554, do the following:

- Select the types of calibration to be performed.
- Enter the measured values for the types selected (except for **CC Offset Calibration**).
- If **Temperature Calibration** is selected, select the sensor that is to be calibrated.
- Click the appropriate button to initiate the desired calibration.

### 9.3 Board Offset Calibration

This performs the offset calibration for the current offset of the board.

- Remove any current source, load, or external voltage from the PACK terminals.
- Click the **Calibrate Board Offset** button.

### 9.4 Pack Voltage Calibration

This calibrates the voltage at the AFE Pack pin.

- Ensure that **Voltage Calibration** has been performed for the pack. If **Voltage Calibration** is not performed, then **Pack Calibration** calibrates incorrectly.
- Remove load and external voltage applied between Pack+ and Pack–.
- Click the **Calibration Pack Voltage** button to calibrate.

**Voltage and Temperature**

Please ensure that scanning/communication is off on all other open windows.

**Voltage and Temperature Calibration**

Voltage: Enter actual cell voltages using stack ground as reference. Cells configured for use are active. Check voltage calibration checkbox.

Temperature: Enter actual sensor temperatures. Check to include in calibration. Click Voltage/Temperature calibration button to calibrate.

Voltage Calibration

Measured voltage	Enter actual voltage	Cell Count
3998 mV	Cell 1 4000 mV	3
7922 mV	Cell 1 + 2 8000 mV	
11920 mV	Cell 1 + 2 + 3 12000 mV	
11920 mV	Cell 1 + 2 + 3 + 4 16000 mV	
11936 mV	Battery Voltage 12000 mV	

Ensure voltage reference is stable. Calibration with cells connected is not recommended unless cells are in a state of rest. If using resistors simulating cells, series resistance must be less than 300 ohms. Configured number of cells in Dataflash available for calibration only. Battery voltage is usually top stack voltage.

Measured temperature	Enter actual temperature
<input type="checkbox"/> Internal Temp 20.0 度	
<input type="checkbox"/> Ext 1 Temp 28.6 度	
<input type="checkbox"/> Ext 2 Temp 28.8 度	

**Pack Calibration**

Measured voltage	Enter actual voltage
110 mV	12000 mV

**Current Values**

Parameter	Value
<b>Voltages</b>	----
Cell Voltage 1	3998
Cell Voltage 2	3924
Cell Voltage 3	3998
Cell Voltage 4	0
Battery Voltage	11936
Pack Voltage	110
<b>Temperatures</b>	----
Internal Temp	20.0
TS1 Temp	28.6
TS2 Temp	28.8
Cell Temp	28.6
FET Temp	28.9

**Raw Calibration Dataflash Values**

Parameter	Value
Cell Scale 0	20451
Cell Scale 1	20468
Cell Scale 2	20520
Cell Scale 3	20517
Pack Gain	49000
Battery Gain	49000
CC Gain	0.942
Capacity Gain	280932.625
Current Offset	-7204
CC Offset Samples	64
Board Offset	0
Int Temp Offset	0
Ext 1 Temp Offset	0
Ext 2 Temp Offset	0

Version: 0.1.0.6 bq8050 Hostcal

**Fuel Gauge** 77%

Communication OK. SBS Task Progress: 100% Task Completed. 03:40:54 PM

Figure 12. Calibration Screen



## 10 Pro (Advanced) Screen

### 10.1 SMB Communication

The set of read or write operations over SMBus are not specific to any gas gauge. These are provided as general-purpose communication tools.

### 10.2 Hex/Decimal Converter

The **Hexadecimal Value** and **Decimal Value** boxes convert between hexadecimal (hex) and decimal as soon as values are typed into the boxes. Invalid values can cause erroneous results.

When scaling converted hex values to a higher number of bytes, follow these rules:

- When **Unsigned** is selected, the left pad contains zeroes.
- When **Signed** is selected, the left pad contains zeroes for a positive number, or the left pad contains *F* for negative numbers.

### 10.3 Reprogramming

To reprogram the device, do the following:

- Ensure that the gauge is in Full Access mode. To do this, use the **Seal/Authentication** screen (see [Section 11](#)).
- Use the **Write SMB Word** feature to put the gauge into ROM mode (0x0033 to cmd 0x00).
- Use the **Srec** programming feature to browse for the desired .srec or .senc file, then click the **Program** button to start the transfer.
- Use the **SMB Command** feature to send 0x08 to execute the program.

If the firmware version was updated, close and re-launch the EVSW to synchronize the tool with the new firmware.

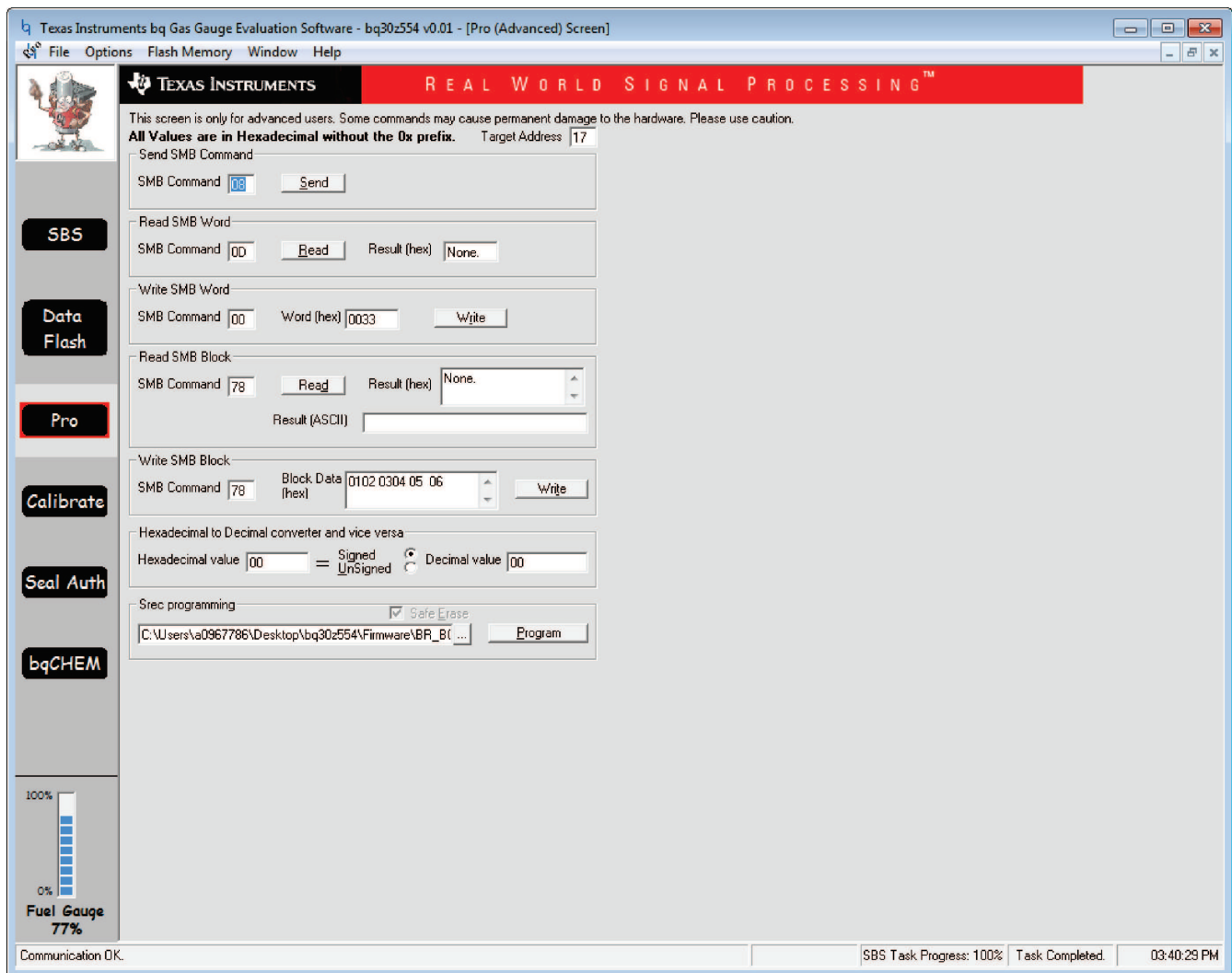

Figure 13. Pro (Advanced) Screen

## 11 Seal/Authentication Screen

To seal, unseal, or allow full access—which enables users to reprogram the device—select one of these three modes on the **Seal/Authentication** screen and click **Go**.

**NOTE:** When the device is sealed, users cannot write to the data flash.

The text boxes at the top of the screen are informational and their content loads during the unseal process.

Unsealing the bq30z554 is the reverse procedure from SHA-1 authentication. (For more information on SHA-1 encryption, refer to the *bq30z5x-R1 Technical Reference Manual* ([SLUU852](#)). The gas gauge generates the random number and challenges the EVSW, which must provide a valid key in order to unseal the device. Full access to ROM mode occurs in a similar manner. The **Seal/Authentication** screen shows the default 128-bit key in the **Key (129 bits)** text box.

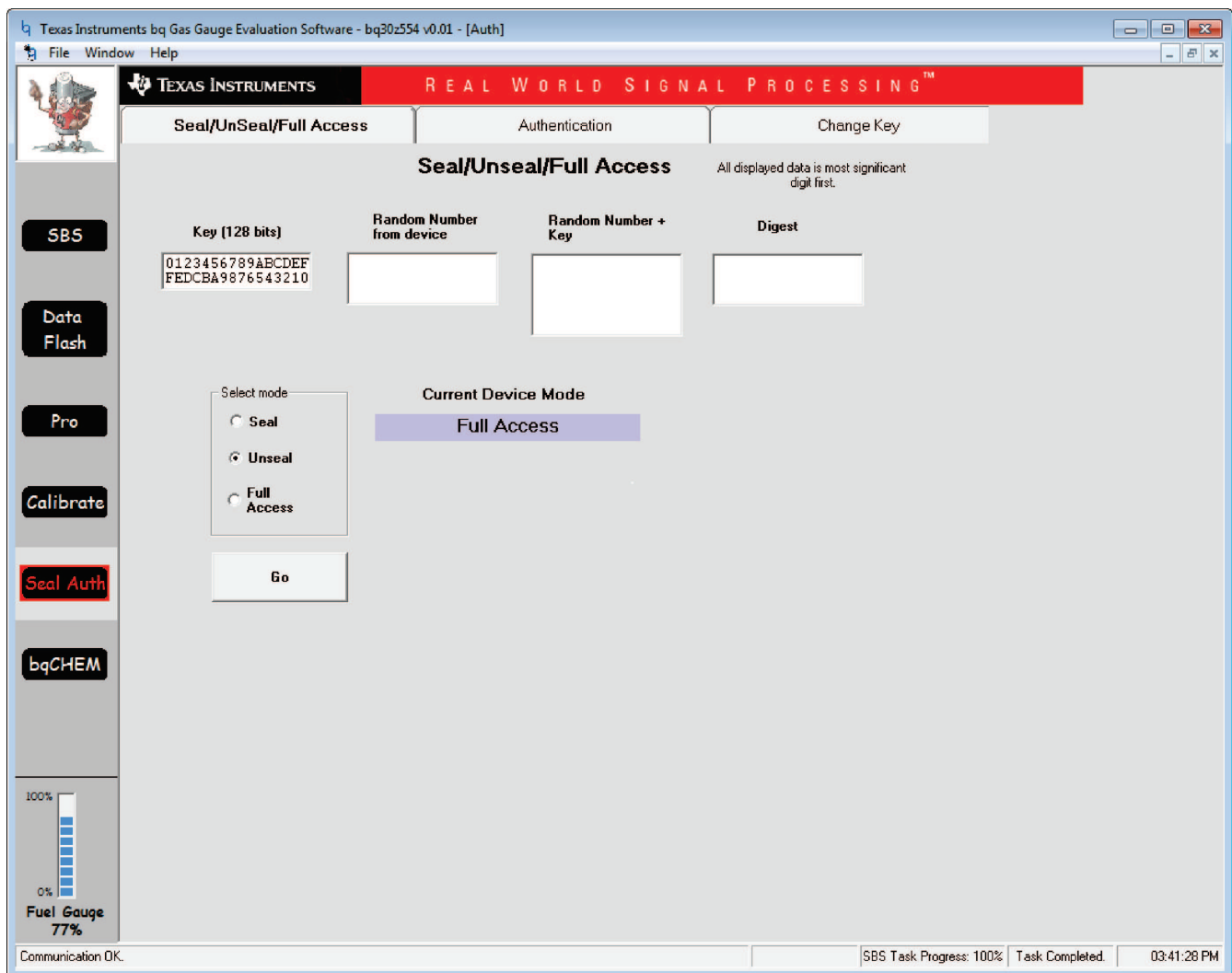
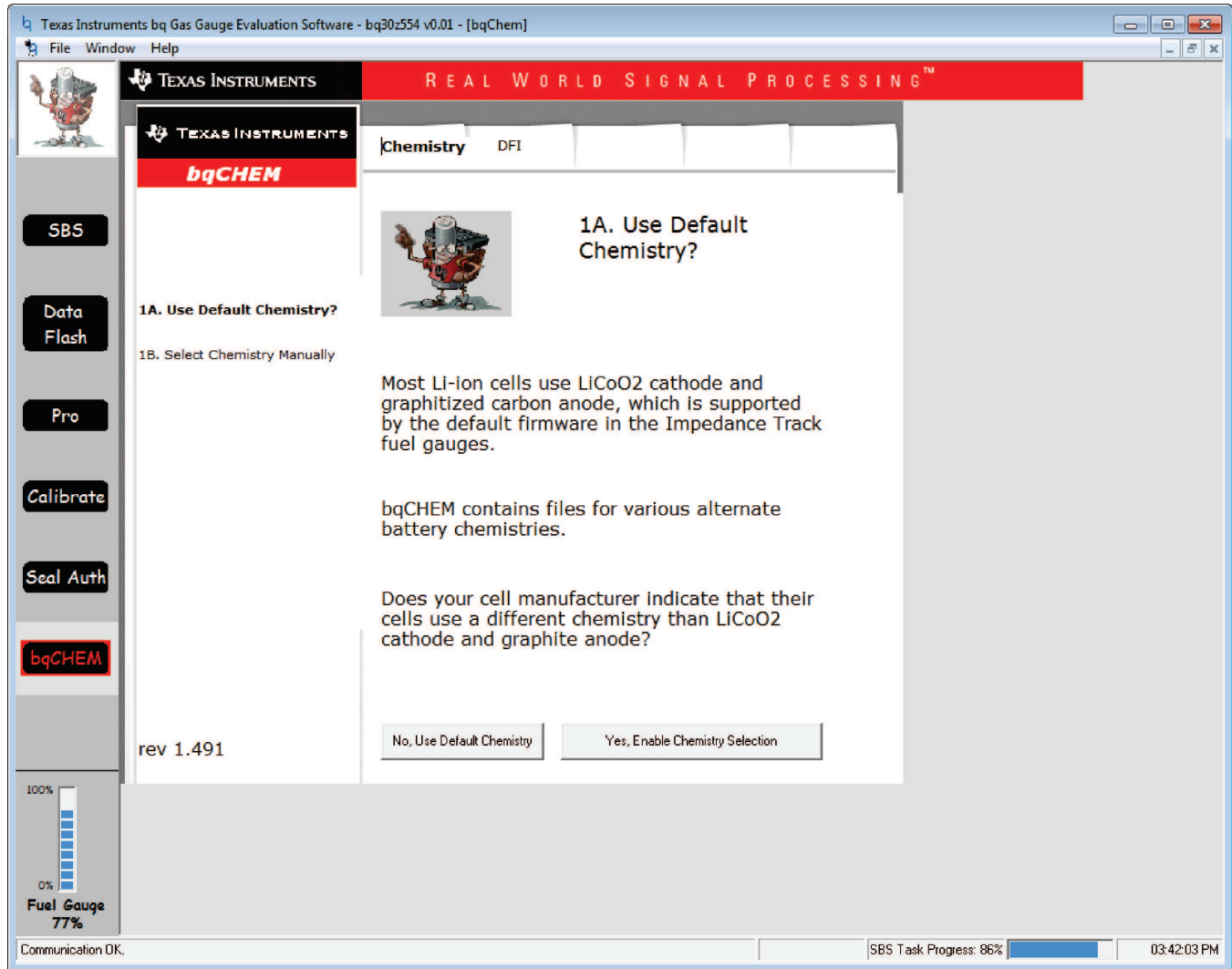

Figure 14. Seal/Authentication Screen

## 12 bqChem

**bqChem** enables users to access the library of previously characterized Li-Ion cell chemistries, and program the chemical database into the gauge. Users can sort by chemical ID or by cell manufacturer. For help to identify the chemistry for the cells, contact the Texas Instruments field representative assigned to work with this device.



**Figure 15. bqChem Screen**

The DFI section enables a user to read and write DFI and ROM files. These are complete binary images of the fuel gauge data flash. Once a golden pack is created, the data flash image can be used to quickly program other packs for mass production. The ROM file contains the same data as the DFI file, but adds an additional header for use by the *bqMTester production* tool. These files differ from the .gg files that a user can read and write in the **Data Flash** screen. The .gg files are simply text dictionaries that contain public configuration data. The DFI and ROM files are binary images that contain public, private, and proprietary information necessary for mass production.

### 13 Related Documentation from Texas Instruments

For related documentation, contact the Texas Instruments field representative assigned to work with this device.

**Documents:**

*bq30z554 SBS 1.1-Compliant Gas Gauge With Impedance  
Track™ Datasheet*

*bq30z5x-R1 Technical Reference Manual*

*EV2300 EVM Interface Board User's Guide*

*EV2400 EVM Interface Board User's Guide*

**Literature Number:**

[SLUSB29A](#)

[SLUU852](#)

[SLUU159A](#)

[SLUU446](#)

## EVALUATION BOARD/KIT/MODULE (EVM) ADDITIONAL TERMS

Texas Instruments (TI) provides the enclosed Evaluation Board/Kit/Module (EVM) under the following conditions:

The user assumes all responsibility and liability for proper and safe handling of the goods. Further, the user indemnifies TI from all claims arising from the handling or use of the goods.

Should this evaluation board/kit not meet the specifications indicated in the User's Guide, the board/kit may be returned within 30 days from the date of delivery for a full refund. THE FOREGOING LIMITED WARRANTY IS THE EXCLUSIVE WARRANTY MADE BY SELLER TO BUYER AND IS IN LIEU OF ALL OTHER WARRANTIES, EXPRESSED, IMPLIED, OR STATUTORY, INCLUDING ANY WARRANTY OF MERCHANTABILITY OR FITNESS FOR ANY PARTICULAR PURPOSE. EXCEPT TO THE EXTENT OF THE INDEMNITY SET FORTH ABOVE, NEITHER PARTY SHALL BE LIABLE TO THE OTHER FOR ANY INDIRECT, SPECIAL, INCIDENTAL, OR CONSEQUENTIAL DAMAGES.

Please read the User's Guide and, specifically, the Warnings and Restrictions notice in the User's Guide prior to handling the product. This notice contains important safety information about temperatures and voltages. For additional information on TI's environmental and/or safety programs, please visit [www.ti.com/esh](http://www.ti.com/esh) or contact TI.

No license is granted under any patent right or other intellectual property right of TI covering or relating to any machine, process, or combination in which such TI products or services might be or are used. TI currently deals with a variety of customers for products, and therefore our arrangement with the user is not exclusive. TI assumes no liability for applications assistance, customer product design, software performance, or infringement of patents or services described herein.

## REGULATORY COMPLIANCE INFORMATION

As noted in the EVM User's Guide and/or EVM itself, this EVM and/or accompanying hardware may or may not be subject to the Federal Communications Commission (FCC) and Industry Canada (IC) rules.

For EVMs **not** subject to the above rules, this evaluation board/kit/module is intended for use for ENGINEERING DEVELOPMENT, DEMONSTRATION OR EVALUATION PURPOSES ONLY and is not considered by TI to be a finished end product fit for general consumer use. It generates, uses, and can radiate radio frequency energy and has not been tested for compliance with the limits of computing devices pursuant to part 15 of FCC or ICES-003 rules, which are designed to provide reasonable protection against radio frequency interference. Operation of the equipment may cause interference with radio communications, in which case the user at his own expense will be required to take whatever measures may be required to correct this interference.

### General Statement for EVMs including a radio

*User Power/Frequency Use Obligations:* This radio is intended for development/professional use only in legally allocated frequency and power limits. Any use of radio frequencies and/or power availability of this EVM and its development application(s) must comply with local laws governing radio spectrum allocation and power limits for this evaluation module. It is the user's sole responsibility to only operate this radio in legally acceptable frequency space and within legally mandated power limitations. Any exceptions to this are strictly prohibited and unauthorized by Texas Instruments unless user has obtained appropriate experimental/development licenses from local regulatory authorities, which is responsibility of user including its acceptable authorization.

### For EVMs annotated as FCC – FEDERAL COMMUNICATIONS COMMISSION Part 15 Compliant

#### Caution

This device complies with part 15 of the FCC Rules. Operation is subject to the following two conditions: (1) This device may not cause harmful interference, and (2) this device must accept any interference received, including interference that may cause undesired operation.

Changes or modifications not expressly approved by the party responsible for compliance could void the user's authority to operate the equipment.

### FCC Interference Statement for Class A EVM devices

This equipment has been tested and found to comply with the limits for a Class A digital device, pursuant to part 15 of the FCC Rules. These limits are designed to provide reasonable protection against harmful interference when the equipment is operated in a commercial environment. This equipment generates, uses, and can radiate radio frequency energy and, if not installed and used in accordance with the instruction manual, may cause harmful interference to radio communications. Operation of this equipment in a residential area is likely to cause harmful interference in which case the user will be required to correct the interference at his own expense.

### **FCC Interference Statement for Class B EVM devices**

This equipment has been tested and found to comply with the limits for a Class B digital device, pursuant to part 15 of the FCC Rules. These limits are designed to provide reasonable protection against harmful interference in a residential installation. This equipment generates, uses and can radiate radio frequency energy and, if not installed and used in accordance with the instructions, may cause harmful interference to radio communications. However, there is no guarantee that interference will not occur in a particular installation. If this equipment does cause harmful interference to radio or television reception, which can be determined by turning the equipment off and on, the user is encouraged to try to correct the interference by one or more of the following measures:

- Reorient or relocate the receiving antenna.
- Increase the separation between the equipment and receiver.
- Connect the equipment into an outlet on a circuit different from that to which the receiver is connected.
- Consult the dealer or an experienced radio/TV technician for help.

### **For EVMs annotated as IC – INDUSTRY CANADA Compliant**

This Class A or B digital apparatus complies with Canadian ICES-003.

Changes or modifications not expressly approved by the party responsible for compliance could void the user's authority to operate the equipment.

### **Concerning EVMs including radio transmitters**

This device complies with Industry Canada licence-exempt RSS standard(s). Operation is subject to the following two conditions: (1) this device may not cause interference, and (2) this device must accept any interference, including interference that may cause undesired operation of the device.

### **Concerning EVMs including detachable antennas**

Under Industry Canada regulations, this radio transmitter may only operate using an antenna of a type and maximum (or lesser) gain approved for the transmitter by Industry Canada. To reduce potential radio interference to other users, the antenna type and its gain should be so chosen that the equivalent isotropically radiated power (e.i.r.p.) is not more than that necessary for successful communication.

This radio transmitter has been approved by Industry Canada to operate with the antenna types listed in the user guide with the maximum permissible gain and required antenna impedance for each antenna type indicated. Antenna types not included in this list, having a gain greater than the maximum gain indicated for that type, are strictly prohibited for use with this device.

Cet appareil numérique de la classe A ou B est conforme à la norme NMB-003 du Canada.

Les changements ou les modifications pas expressément approuvés par la partie responsable de la conformité ont pu vider l'autorité de l'utilisateur pour actionner l'équipement.

### **Concernant les EVMs avec appareils radio**

Le présent appareil est conforme aux CNR d'Industrie Canada applicables aux appareils radio exempts de licence. L'exploitation est autorisée aux deux conditions suivantes : (1) l'appareil ne doit pas produire de brouillage, et (2) l'utilisateur de l'appareil doit accepter tout brouillage radioélectrique subi, même si le brouillage est susceptible d'en compromettre le fonctionnement.

### **Concernant les EVMs avec antennes détachables**

Conformément à la réglementation d'Industrie Canada, le présent émetteur radio peut fonctionner avec une antenne d'un type et d'un gain maximal (ou inférieur) approuvé pour l'émetteur par Industrie Canada. Dans le but de réduire les risques de brouillage radioélectrique à l'intention des autres utilisateurs, il faut choisir le type d'antenne et son gain de sorte que la puissance isotrope rayonnée équivalente (p.i.r.e.) ne dépasse pas l'intensité nécessaire à l'établissement d'une communication satisfaisante.

Le présent émetteur radio a été approuvé par Industrie Canada pour fonctionner avec les types d'antenne énumérés dans le manuel d'usage et ayant un gain admissible maximal et l'impédance requise pour chaque type d'antenne. Les types d'antenne non inclus dans cette liste, ou dont le gain est supérieur au gain maximal indiqué, sont strictement interdits pour l'exploitation de l'émetteur.

## **【Important Notice for Users of this Product in Japan】**

### **This development kit is NOT certified as Confirming to Technical Regulations of Radio Law of Japan**

If you use this product in Japan, you are required by Radio Law of Japan to follow the instructions below with respect to this product:

1. Use this product in a shielded room or any other test facility as defined in the notification #173 issued by Ministry of Internal Affairs and Communications on March 28, 2006, based on Sub-section 1.1 of Article 6 of the Ministry's Rule for Enforcement of Radio Law of Japan,
2. Use this product only after you obtained the license of Test Radio Station as provided in Radio Law of Japan with respect to this product, or
3. Use of this product only after you obtained the Technical Regulations Conformity Certification as provided in Radio Law of Japan with respect to this product. Also, please do not transfer this product, unless you give the same notice above to the transferee. Please note that if you could not follow the instructions above, you will be subject to penalties of Radio Law of Japan.

**Texas Instruments Japan Limited**  
**(address) 24-1, Nishi-Shinjuku 6 chome, Shinjuku-ku, Tokyo, Japan**

<http://www.tij.co.jp>

#### **【ご使用にあたっての注】**

本開発キットは技術基準適合証明を受けておりません。

本製品のご使用に際しては、電波法遵守のため、以下のいずれかの措置を取っていただく必要がありますのでご注意ください。

1. 電波法施行規則第6条第1項第1号に基づく平成18年3月28日総務省告示第173号で定められた電波暗室等の試験設備でご使用いただく。
2. 実験局の免許を取得後ご使用いただく。
3. 技術基準適合証明を取得後ご使用いただく。

なお、本製品は、上記の「ご使用にあたっての注意」を譲渡先、移転先に通知しない限り、譲渡、移転できないものとします。

上記を遵守頂けない場合は、電波法の罰則が適用される可能性があることをご留意ください。

日本テキサス・インスツルメンツ株式会社  
東京都新宿区西新宿6丁目24番1号  
西新宿三井ビル

<http://www.tij.co.jp>



## EVALUATION BOARD/KIT/MODULE (EVM) WARNINGS, RESTRICTIONS AND DISCLAIMERS

**For Feasibility Evaluation Only, in Laboratory/Development Environments.** Unless otherwise indicated, this EVM is not a finished electrical equipment and not intended for consumer use. It is intended solely for use for preliminary feasibility evaluation in laboratory/development environments by technically qualified electronics experts who are familiar with the dangers and application risks associated with handling electrical mechanical components, systems and subsystems. It should not be used as all or part of a finished end product.

Your Sole Responsibility and Risk. You acknowledge, represent and agree that:

1. You have unique knowledge concerning Federal, State and local regulatory requirements (including but not limited to Food and Drug Administration regulations, if applicable) which relate to your products and which relate to your use (and/or that of your employees, affiliates, contractors or designees) of the EVM for evaluation, testing and other purposes.
2. You have full and exclusive responsibility to assure the safety and compliance of your products with all such laws and other applicable regulatory requirements, and also to assure the safety of any activities to be conducted by you and/or your employees, affiliates, contractors or designees, using the EVM. Further, you are responsible to assure that any interfaces (electronic and/or mechanical) between the EVM and any human body are designed with suitable isolation and means to safely limit accessible leakage currents to minimize the risk of electrical shock hazard.
3. You will employ reasonable safeguards to ensure that your use of the EVM will not result in any property damage, injury or death, even if the EVM should fail to perform as described or expected.
4. You will take care of proper disposal and recycling of the EVM's electronic components and packing materials.

**Certain Instructions.** It is important to operate this EVM within TI's recommended specifications and environmental considerations per the user guidelines. Exceeding the specified EVM ratings (including but not limited to input and output voltage, current, power, and environmental ranges) may cause property damage, personal injury or death. If there are questions concerning these ratings please contact a TI field representative prior to connecting interface electronics including input power and intended loads. Any loads applied outside of the specified output range may result in unintended and/or inaccurate operation and/or possible permanent damage to the EVM and/or interface electronics. Please consult the EVM User's Guide prior to connecting any load to the EVM output. If there is uncertainty as to the load specification, please contact a TI field representative. During normal operation, some circuit components may have case temperatures greater than 60°C as long as the input and output are maintained at a normal ambient operating temperature. These components include but are not limited to linear regulators, switching transistors, pass transistors, and current sense resistors which can be identified using the EVM schematic located in the EVM User's Guide. When placing measurement probes near these devices during normal operation, please be aware that these devices may be very warm to the touch. As with all electronic evaluation tools, only qualified personnel knowledgeable in electronic measurement and diagnostics normally found in development environments should use these EVMs.

**Agreement to Defend, Indemnify and Hold Harmless.** You agree to defend, indemnify and hold TI, its licensors and their representatives harmless from and against any and all claims, damages, losses, expenses, costs and liabilities (collectively, "Claims") arising out of or in connection with any use of the EVM that is not in accordance with the terms of the agreement. This obligation shall apply whether Claims arise under law of tort or contract or any other legal theory, and even if the EVM fails to perform as described or expected.

**Safety-Critical or Life-Critical Applications.** If you intend to evaluate the components for possible use in safety critical applications (such as life support) where a failure of the TI product would reasonably be expected to cause severe personal injury or death, such as devices which are classified as FDA Class III or similar classification, then you must specifically notify TI of such intent and enter into a separate Assurance and Indemnity Agreement.

Mailing Address: Texas Instruments, Post Office Box 655303, Dallas, Texas 75265  
Copyright © 2012, Texas Instruments Incorporated

## IMPORTANT NOTICE

Texas Instruments Incorporated and its subsidiaries (TI) reserve the right to make corrections, enhancements, improvements and other changes to its semiconductor products and services per JESD46, latest issue, and to discontinue any product or service per JESD48, latest issue. Buyers should obtain the latest relevant information before placing orders and should verify that such information is current and complete. All semiconductor products (also referred to herein as "components") are sold subject to TI's terms and conditions of sale supplied at the time of order acknowledgment.

TI warrants performance of its components to the specifications applicable at the time of sale, in accordance with the warranty in TI's terms and conditions of sale of semiconductor products. Testing and other quality control techniques are used to the extent TI deems necessary to support this warranty. Except where mandated by applicable law, testing of all parameters of each component is not necessarily performed.

TI assumes no liability for applications assistance or the design of Buyers' products. Buyers are responsible for their products and applications using TI components. To minimize the risks associated with Buyers' products and applications, Buyers should provide adequate design and operating safeguards.

TI does not warrant or represent that any license, either express or implied, is granted under any patent right, copyright, mask work right, or other intellectual property right relating to any combination, machine, or process in which TI components or services are used. Information published by TI regarding third-party products or services does not constitute a license to use such products or services or a warranty or endorsement thereof. Use of such information may require a license from a third party under the patents or other intellectual property of the third party, or a license from TI under the patents or other intellectual property of TI.

Reproduction of significant portions of TI information in TI data books or data sheets is permissible only if reproduction is without alteration and is accompanied by all associated warranties, conditions, limitations, and notices. TI is not responsible or liable for such altered documentation. Information of third parties may be subject to additional restrictions.

Resale of TI components or services with statements different from or beyond the parameters stated by TI for that component or service voids all express and any implied warranties for the associated TI component or service and is an unfair and deceptive business practice. TI is not responsible or liable for any such statements.

Buyer acknowledges and agrees that it is solely responsible for compliance with all legal, regulatory and safety-related requirements concerning its products, and any use of TI components in its applications, notwithstanding any applications-related information or support that may be provided by TI. Buyer represents and agrees that it has all the necessary expertise to create and implement safeguards which anticipate dangerous consequences of failures, monitor failures and their consequences, lessen the likelihood of failures that might cause harm and take appropriate remedial actions. Buyer will fully indemnify TI and its representatives against any damages arising out of the use of any TI components in safety-critical applications.

In some cases, TI components may be promoted specifically to facilitate safety-related applications. With such components, TI's goal is to help enable customers to design and create their own end-product solutions that meet applicable functional safety standards and requirements. Nonetheless, such components are subject to these terms.

No TI components are authorized for use in FDA Class III (or similar life-critical medical equipment) unless authorized officers of the parties have executed a special agreement specifically governing such use.

Only those TI components which TI has specifically designated as military grade or "enhanced plastic" are designed and intended for use in military/aerospace applications or environments. Buyer acknowledges and agrees that any military or aerospace use of TI components which have **not** been so designated is solely at the Buyer's risk, and that Buyer is solely responsible for compliance with all legal and regulatory requirements in connection with such use.

TI has specifically designated certain components which meet ISO/TS16949 requirements, mainly for automotive use. Components which have not been so designated are neither designed nor intended for automotive use; and TI will not be responsible for any failure of such components to meet such requirements.

### Products

Audio	<a href="http://www.ti.com/audio">www.ti.com/audio</a>
Amplifiers	<a href="http://amplifier.ti.com">amplifier.ti.com</a>
Data Converters	<a href="http://dataconverter.ti.com">dataconverter.ti.com</a>
DLP® Products	<a href="http://www.dlp.com">www.dlp.com</a>
DSP	<a href="http://dsp.ti.com">dsp.ti.com</a>
Clocks and Timers	<a href="http://www.ti.com/clocks">www.ti.com/clocks</a>
Interface	<a href="http://interface.ti.com">interface.ti.com</a>
Logic	<a href="http://logic.ti.com">logic.ti.com</a>
Power Mgmt	<a href="http://power.ti.com">power.ti.com</a>
Microcontrollers	<a href="http://microcontroller.ti.com">microcontroller.ti.com</a>
RFID	<a href="http://www.ti-rfid.com">www.ti-rfid.com</a>
OMAP Applications Processors	<a href="http://www.ti.com/omap">www.ti.com/omap</a>
Wireless Connectivity	<a href="http://www.ti.com/wirelessconnectivity">www.ti.com/wirelessconnectivity</a>

### Applications

Automotive and Transportation	<a href="http://www.ti.com/automotive">www.ti.com/automotive</a>
Communications and Telecom	<a href="http://www.ti.com/communications">www.ti.com/communications</a>
Computers and Peripherals	<a href="http://www.ti.com/computers">www.ti.com/computers</a>
Consumer Electronics	<a href="http://www.ti.com/consumer-apps">www.ti.com/consumer-apps</a>
Energy and Lighting	<a href="http://www.ti.com/energy">www.ti.com/energy</a>
Industrial	<a href="http://www.ti.com/industrial">www.ti.com/industrial</a>
Medical	<a href="http://www.ti.com/medical">www.ti.com/medical</a>
Security	<a href="http://www.ti.com/security">www.ti.com/security</a>
Space, Avionics and Defense	<a href="http://www.ti.com/space-avionics-defense">www.ti.com/space-avionics-defense</a>
Video and Imaging	<a href="http://www.ti.com/video">www.ti.com/video</a>
<b>TI E2E Community</b>	<a href="http://e2e.ti.com">e2e.ti.com</a>