

# 219XA Series

## 5×20mm, Time-Lag Fuse



### Additional Information



Resources



Accessories



Samples

### Electrical Characteristics for Series

% of Ampere Rating	Ampere Rating	Opening Time
150%	0.04A - 0.1A	1 hours, Minimum
	0.125A - 6.3A	1 hours, Minimum
210%	0.04A - 0.1A	2 minutes, Maximum
	0.125A - 6.3A	2 minutes, Maximum
275%	0.04A - 0.1A	0.2 sec., Min; 10 sec. Max
	0.125A - 6.3A	0.6 sec., Min; 10 sec. Max
400%	0.04A - 0.1A	0.04 sec., Min; 3 sec. Max
	0.125A - 6.3A	.15 sec., Min; 3 sec. Max
1000%	0.04A - 0.1A	.01 sec., Min; 0.3 sec. Max
	0.125A - 6.3A	.02 sec., Min; 0.3 sec. Max



### Description

5×20mm time-Lag glass body cartridge fuse designed to IEC specification.

### Features

- Designed to International IEC Standards for use globally
- Available in cartridge and axial lead form
- Meets the IEC 60127-2, Sheet 6 specification for time-Lag fuses
- RoHS compliant and lead-free

### Applications

Used as supplementary protection in appliance or utilization equipment to provide individual protection for components or internal circuits.









### Agency Approvals

Agency	Agency File/Certificate Number	Ampere Range
PS	Cartridge: NBK220604-E10480A DPC NBK230604-E10480A	1A - 5A 6.3A
	Leaded: NBK220604-E10480B NBK230604-E10480B	1A - 5A 6.3A
CCC	CCC self declaration No.:2020970207000068	0.040A-6.3A
cULus	E10480	0.040A - 6.3A
SP	29862	0.125A - 6.3A
S	1620075	0.040A - 6.3A
DVE	40016080	0.040A - 6.3A
VD	KM41462	0.125A - 6.3A
CE	N/A	0.040A - 6.3A
EAC	RU C-DE.HB26.B.01385/21	

# 219XA Series

## 5×20mm, Time-Lag Fuse

### Electrical Characteristic Specifications by Item

Amp Code	Amp Rating (A)	Voltage Rating (V)	Interrupting Rating	Nominal Cold Resistance (Ohms)	Nominal Melting Pt (A <sup>2</sup> sec)	Maximum Voltage Drop at Rated Current (mV)	Maximum Power Dissipation at 1.5I <sub>n</sub> (W)	Agency Approvals							
															
.040	0.040	250	150A @ 250VAC	31.8620	0.01640	4000	1.6			x		x	x	x	
.050	0.050	250		21.2920	0.01700	3500	1.6			x		x	x	x	
.063	0.063	250		14.2685	0.03800	3000	1.6			x		x	x	x	
.100	0.100	250		6.0180	0.07900	2500	1.6			x		x	x	x	
.125	0.125	250		4.2000	0.13000	2000	1.6	x		x	x	x	x	x	x
.160	0.160	250		2.5500	0.31000	1900	1.6	x		x	x	x	x	x	x
.200	0.200	250		1.6000	0.32000	1500	1.6	x		x	x	x	x	x	x
.250	0.250	250		1.0495	0.54000	1300	1.6	x		x	x	x	x	x	x
.315	0.315	250		0.8475	1.23000	1100	1.6	x		x	x	x	x	x	x
.400	0.400	250		0.5350	1.40000	1000	1.6	x		x	x	x	x	x	x
.500	0.500	250		0.3700	3.00000	900	1.6	x		x	x	x	x	x	x
.630	0.630	250		0.2750	4.82000	300	1.6	x		x	x	x	x	x	x
.800	0.800	250		0.1635	9.35000	250	1.6	x		x	x	x	x	x	x
001.	1.00	250		0.1165	19.20000	150	1.6	x	x	x	x	x	x	x	x
1.25	1.25	250		0.0817	27.15000	150	1.6	x	x	x	x	x	x	x	x
01.6	1.60	250		0.0551	44.20000	150	1.6	x	x	x	x	x	x	x	x
002.	2.00	250		0.0452	92.70500	150	1.6	x	x	x	x	x	x	x	x
02.5	2.50	250		0.0305	138.00000	120	1.6	x	x	x	x	x	x	x	x
3.15	3.15	250		0.0231	202.00000	100	1.6	x	x	x	x	x	x	x	x
004.	4.00	250		0.0158	330.00000	100	1.6	x	x	x	x	x	x	x	x
005.	5.00	250	0.0117	544.00000	100	1.6	x	x	x	x	x	x	x	x	
06.3	6.3	250	0.0107	1093.03500	100	1.6	x	x	x	x	x	x	x	x	

\*4A-6.3A have an Interrupting rating 100A@350Vac.

# 219XA Series

## 5x20mm, Time-Lag Fuse

Temperature Re-rating Curve

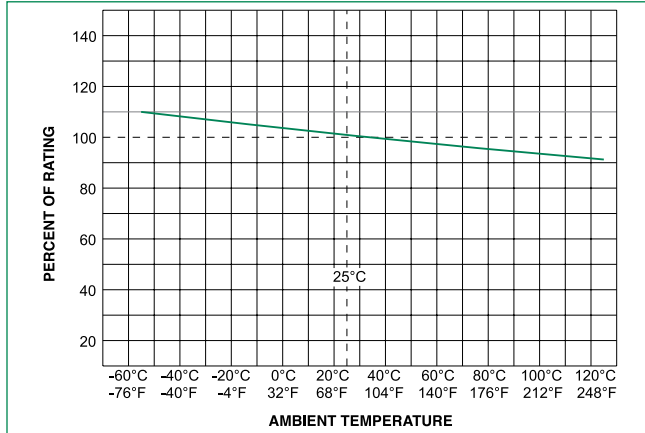

Average Time Current Curves

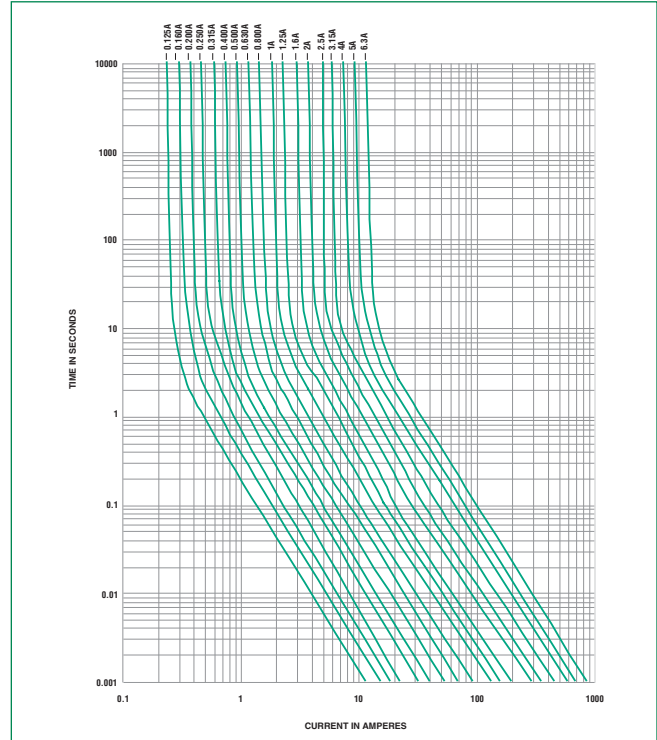

Soldering Parameters - Wave Soldering

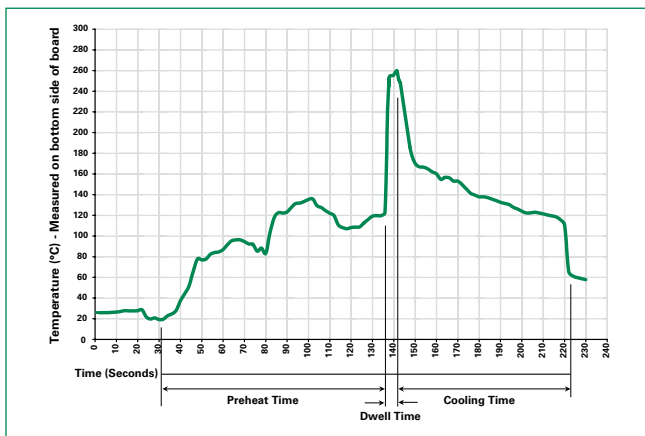

**Recommended Process Parameters:**

Wave Parameter	Lead-Free Recommendation
Preheat: (Depends on Flux Activation Temperature)	(Typical Industry Recommendation)
Temperature Minimum:	100°C
Temperature Maximum:	150°C
Preheat Time:	60-180 seconds
Solder Pot Temperature:	260°C Maximum
Solder Dwell Time:	2-5 seconds

**Recommended Hand-Solder Parameters:**

Solder Iron Temperature: 350°C +/- 5°C  
 Heating Time: 5 seconds max.

**Note:** These devices are not recommended for IR or Convection Reflow process.

**Packaging**

Packaging Option	Packaging Specification	Quantity	Quantity & Packaging Code	Taping Width
<b>219XA Series</b>				
Bulk	N/A	1000	MXA	N/A
Bulk	N/A	1000	MXAE	N/A
Reel and Tape	EIA 296-E	1000	MRAET1	T1=53mm (2.087")
Bulk	N/A	1000	MXG	N/A

# 219XA Series

## 5×20mm, Time-Lag Fuse

### Product Characteristics

<b>Materials</b>	Body: Glass Cap: Nickel Plated Brass Leads: Tin Plated Copper
<b>Terminal Strength</b>	MIL-STD-202, Method 211. Test Condition A
<b>Solderability</b>	MIL-STD-202 Method 208
<b>Product Marking</b>	Cap 1: Brand logo, current and voltage rating Cap 2: Agency approval markings Series
<b>Packaging</b>	Available in Bulk (M=1000 pcs/pkg) or on Tape/Reel (MRET1=1000 pcs/reel)

<b>Operating Temperature</b>	-55°C to +125°C
<b>Shock</b>	MIL-STD-202, Method 107, Test Condition B: (5 cycles -65°C to +125°C)
<b>Vibration</b>	MIL-STD-202, Method 201
<b>Humidity</b>	MIL-STD-202, Method 103, Test Condition A high RH (95%) and elevated temperature (40°C) for 240 hours.
<b>Salt Spray</b>	MIL-STD-202 Method 101, Test Condition B

### Dimensions

All dimensions in mm

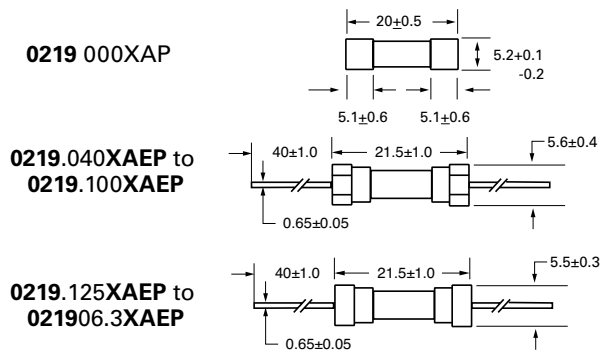

### Part Numbering System

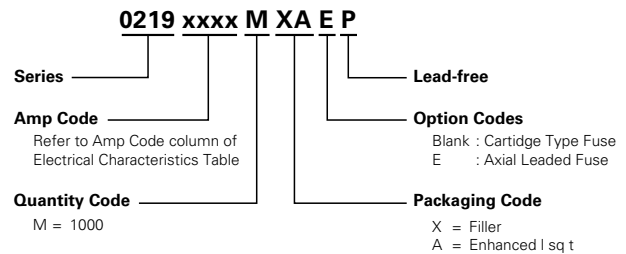

### Recommended Accessories

Accessory Type	Series	Description	Max Application Voltage	Max Application Amperage
Holder	<a href="#">345_ISF</a>	Panel Mount Shock-Safe Fuseholder	250	10
	<a href="#">345</a>	Shock-Safe Fuseholder with PC Mount, Solder Mount and Panel Mount options		20
	<a href="#">830</a>	PC Mount Shock-Safe Miniature Fuseholder		16
Block	<a href="#">520</a>	Metric OMNI-BLOK® Fuse Block		10
	<a href="#">646</a>	PC Mount Miniature Fuse Block		6.3
	<a href="#">658</a>	Surface Mount Miniature Fuse Block		10
Clip	<a href="#">520_WV</a>	PC Mount Miniature Fuse Clip		6.3
	<a href="#">111</a>	PC Board Mount Fuse Clip		10
	<a href="#">445</a>	PC Board Mount Fuse Clip		10

- Notes:**
- Do not use in applications above rating.
  - Please refer to fuseholder data sheet for specific re-rating information.
  - Please contact factory for applications greater than the max voltage and amperage shown.

**Disclaimer Notice** - Information furnished is believed to be accurate and reliable. However, users should independently evaluate the suitability of and test each product selected for their own applications. Littelfuse products are not designed for, and may not be used in, all applications. Read complete Disclaimer Notice at: [www.littelfuse.com/disclaimer-electronics](http://www.littelfuse.com/disclaimer-electronics).