

408/424 SERIES



METAL TO METAL CARD EDGE CONNECTORS

Features:

- 0.200" (5.08mm) contact spacing x 0.125" (3.18mm) or 0.150" (3.81mm) row spacing with staggered grid
- Accepts 0.062" (1.57mm) or 0.093" (2.36mm) nominal thickness P.C. board
- Edacon hermaphroditic contact mating design
- Contact termination options include P.C. tail, fork tail, wire hole and wire wrap
- Open or closed card slot ends, card guides optional
- Accepts polarizing keys without loss of contact position
- 408 series without card guides designed to mate with 421 Series, 408 Series with card guides designed to mate with 422 Series, 424 Series designed to mate with 423 Series
- RoHS Compliant

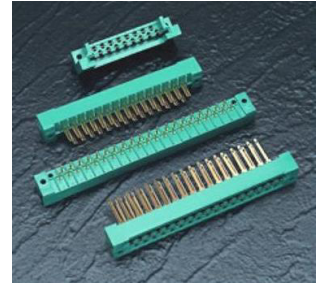

Specifications:

Insulator Material	UL 94V-0 Diallyl Phthalate, Green Color
Contact Material	Copper Alloy
Contact Plating	Gold Plating over Nickel over entire contact
Current Rating	10 amps
Contact Resistance	10 milliohms maximum
Dielectric Withstanding Voltage	2000 V AC rms at sea level
Insulation Resistance	5000 megaohms minimum
Operating Temperature	-65°C to +125°C
Insertion Force	2 to 16 oz (0.56 to 4.45 N) per contact position
Withdrawal Force	2 to 16 oz (0.56 to 4.45 N) per contact position

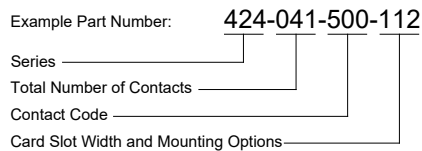

Series:	Insulator Color:
408	Closed Card Slot Ends
424	Open Card Slot Ends per Mil-C-21097
Total Number of Contacts:	
017, 023, 029, 035, 041 or 047	

Contact Code:	Description:	Tail Size:	Tail Length "G":
500	Wire Hole	.115 x .025 (2.92 x 0.64)	.326 (8.28)
502	Fork Tail	.115 x .025 (2.92 x 0.64)	.168 (4.27)
520	P.C. Tail	.044 x .025 (1.12 x 0.64)	.123 (3.12)
521	P.C. Tail	.044 x .025 (1.12 x 0.64)	.154 (3.91)
522	P.C. Tail	.044 x .025 (1.12 x 0.64)	.186 (4.72)
523	P.C. Tail	.044 x .025 (1.12 x 0.64)	.123 (3.12)
524	P.C. Tail	.044 x .025 (1.12 x 0.64)	.154 (3.91)
525	P.C. Tail	.044 x .025 (1.12 x 0.64)	.186 (4.72)
540	Wire Wrap	.060 x .025 (1.52 x 0.64)	.744 (18.90)
541	Wire Wrap	.060 x .025 (1.52 x 0.64)	.744 (18.90)
542	Wire Wrap	.060 x .025 (1.52 x 0.64)	.965 (24.51)

- Ordering Code Notes:**
- 1) Contact Codes 523, 524 and 525 are designed for 0.150" (3.81mm) row spacing connectors.
 - 2) Contact code 540 has a wire hole at the tip of the tail.
 - 3) Mounting options 212 and 222 are available on the 408 series connectors only.

Card Slot Width:	Mounting Options:	Description:
112	Accepts .062(1.57) Board	.128(3.25)Dia.Mounting Holes
122	Accepts .093(2.36) Board	.128(3.25)Dia.Mounting Holes
212	Accepts .062(1.57) Board	.128(3.25)Dia.Mounting Holes With Card Guides
222	Accepts .093(2.36) Board	.128(3.25)Dia.Mounting Holes With Card Guides

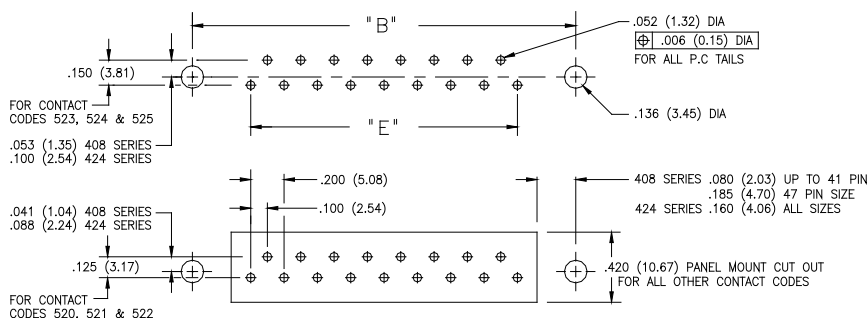

CONNECTOR MOUNTING PATTERNS FOR 408 & 424 SERIES

METAL TO METAL CARD EDGE CONNECTORS

408 SERIES CONNECTOR

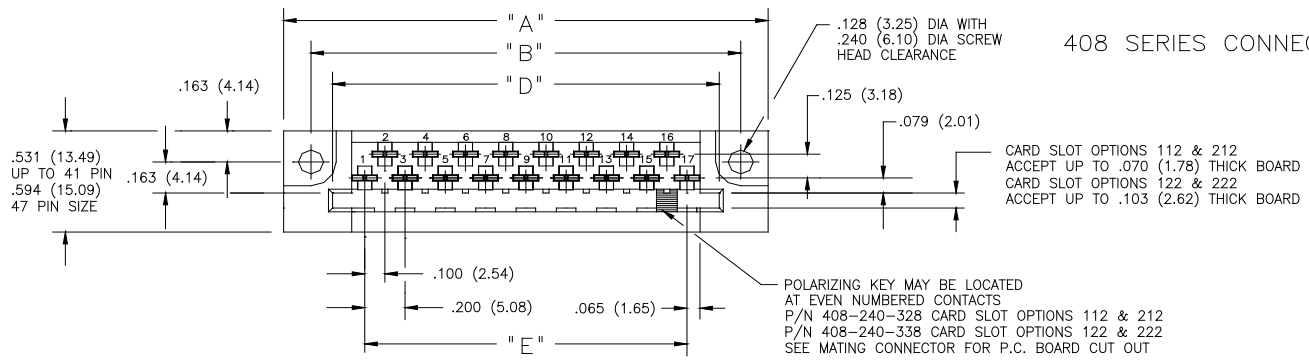

END VIEW WITHOUT CARD GUIDE

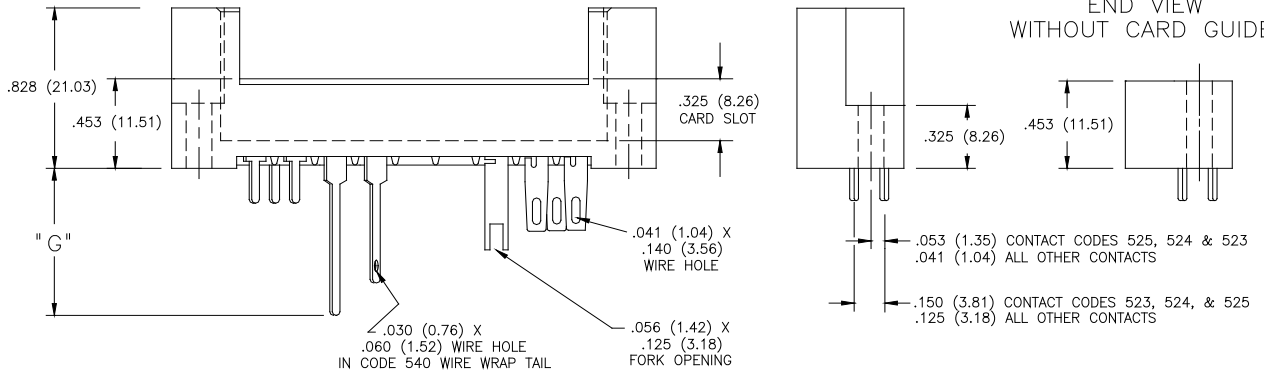

424 SERIES CONNECTOR

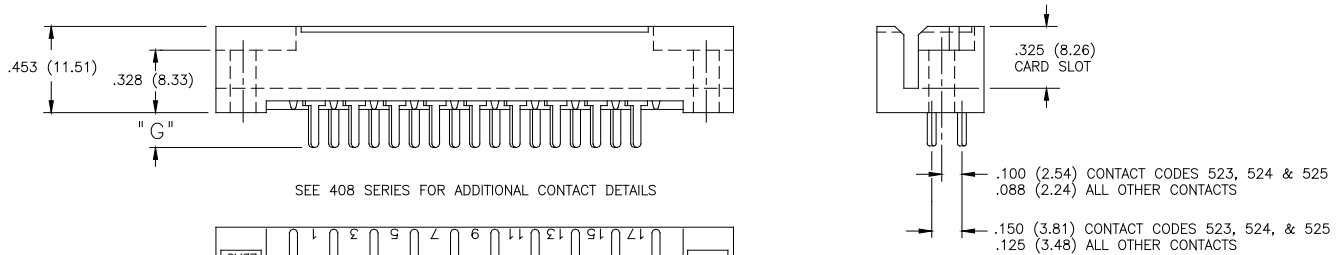
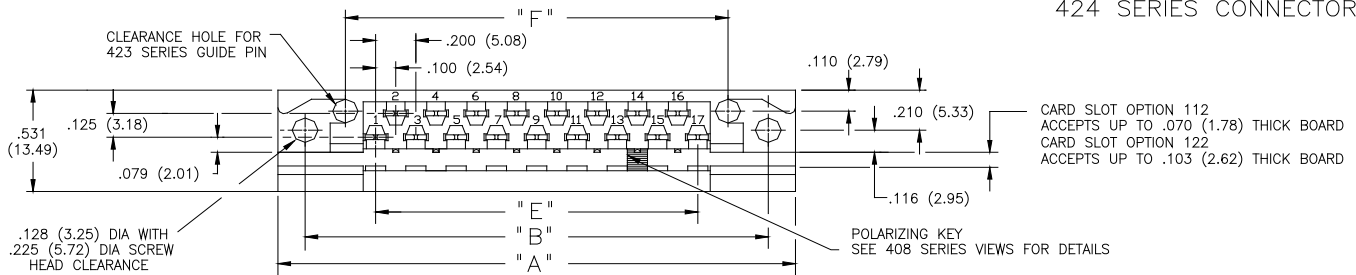

SEE 408 SERIES FOR ADDITIONAL CONTACT DETAILS

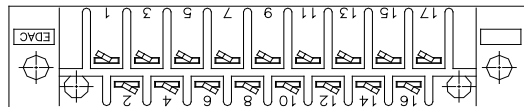

NUMBER OF CONTACTS	"A"		"B"		"D"		"E"		"F"					
	408		424		408		424		408, 424		424			
	inch	mm	inch	mm	inch	mm	inch	mm	inch	mm	inch	mm		
17	2.406	61.11	2.570	65.28	2.134	54.20	2.300	58.42	1.920	48.77	1.600	40.64	1.900	48.26
23	3.006	76.35	3.170	80.52	2.734	69.44	2.900	73.66	2.520	64.01	2.200	55.88	2.500	63.50
29	3.606	91.59	3.770	95.76	3.334	84.68	3.500	88.90	3.120	79.25	2.800	71.12	3.100	78.74
35	4.206	106.83	4.370	111.00	3.934	99.92	4.100	104.14	3.720	94.49	3.400	86.36	3.700	93.98
41	4.806	122.07	4.970	126.24	4.534	115.16	4.700	119.38	4.320	109.73	4.000	101.60	4.300	109.22