

# 629C/630C SERIES



## Power Combo D-Sub Connectors: Right Angle

### Features:

- Signal, along with power or coaxial contacts within one connector
- Space saving on the PCB and I/O designs
- Available in various pin out configurations
- Pin and socket contact mating design with P.C. tail termination
- Metal shell provides EMI/RFI shielding, plug shell indents provide grounding and additional mating retention
- Mounting options for panel mount or connector mating include through hole, threaded hole and threaded standoffs
- D-shaped connector mating outline provides polarization

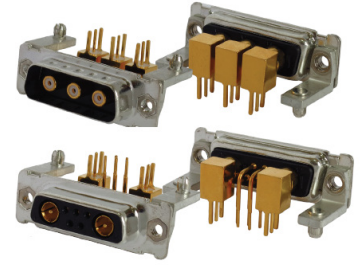

### Specifications:

	Power/Coaxial Only	Combination
Insulator Material	Thermoplastic Polyester, UL 94V-0, Color: Black	
Contact Material	Copper Alloy	
Contact Plating	Selective Gold (See Ordering Code) over Nickel for the Mating Area, Tin Plating for Tail Area	
Shell Material and Plating	Steel, Sn or Ni Plated	
Shell Material	Nickel Plated Steel	
Current Rating (Power Contacts)	10 amps, 20 amps, 30 amps, 40 amps	
Current Rating (Signal Contacts)		5 amps
Voltage Rating	125 V	
Contact Resistance (Power Contacts)	1 Milliohms maximum	
Contact Resistance (Signal Contacts)		10 Milliohms maximum
Insulation Resistance	5000 megohms minimum	
Dielectric Withstanding Voltage	1000 V AC rms at Sea Level	
Operating Temperature	-55°C To +125°C	
Mating Cycle	500 For 30 Microinches Gold Plating, 50 For Gold Flash Plating	

### Ordering Code:

**629-2W2-220-1N2**

SERIES: \_\_\_\_\_  
 629: PLUG (PIN)  
 630: RECEPTACLE (SOCKET)

LAYOUT: \_\_\_\_\_

	POWER/CO-AX ONLY		COMBINATION			
SIZE 9 CONTACT SHELL	2W2	2WK2	5W1			
SIZE 15 CONTACT SHELL	3W3	3WK3	7W2	11W1		
SIZE 25 CONTACT SHELL	5W5		9W4	13W3	17W2	21W1
SIZE 37 CONTACT SHELL	8W8		13W6	17W5	25W3	27W2 21W4
SIZE 50 CONTACT SHELL			24W7	36W4	43W2	47W1

8W8                      2WK2  
 TOTAL NO. OF POWER OR CO-AX CONTACT    MALE FEMALE COMBINATION  
 TOTAL NO. OF CONTACT

CONTACT PLATING THICKNESS: \_\_\_\_\_  
 2 - GOLD FLASH PLATING  
 6 - 30 MICROINCHES OF GOLD PLATING

TAIL TYPE: \_\_\_\_\_  
 40 - PC TAIL  
 50 - PC TAIL 20.33mm FOOTPRINT (POWER CONTACT ONLY)

#### MOUNTING OPTIONS:

- 1 - THROUGH HOLE
  - 2 - #4-40 UNC THREADED HOLE ONLY
  - 3 - #4-40 UNC THREADED HOLE, MOUNTING BRACKET, BOARDLOCK
  - 4 - #4-40 UNC THREADED HOLE, MOUNTING BRACKET
  - 5 - #4-40 UNC THREADED STANDOFF, MOUNTING BRACKET, BOARDLOCK
  - 6 - #4-40 UNC THREADED STANDOFF, MOUNTING BRACKET
- A - M3 THREADED HOLE ONLY  
 B - M3 THREADED HOLE, MOUNTING BRACKET, BOARDLOCK  
 C - M3 THREADED HOLE, MOUNTING BRACKET  
 D - M3 THREADED STANDOFF, MOUNTING BRACKET, BOARDLOCK  
 E - M3 THREADED STANDOFF, MOUNTING BRACKET

#### SHELL PLATING:

- N - NICKEL  
 T - TIN

#### RATING:

- |                 |                   |
|-----------------|-------------------|
| POWER CONTACT   | COAXIAL CONTACT   |
| CURRENT RATING: | IMPEDANCE RATING: |
| 1 - 10A         | 5 - 50 OHMS       |
| 2 - 20A         | 7 - 75 OHMS       |
| 3 - 30A         |                   |
| 4 - 40A         |                   |

### Layout:

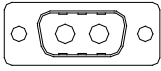
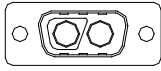
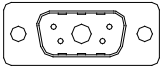
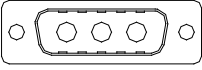
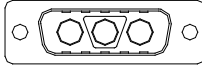
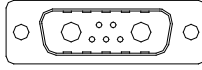
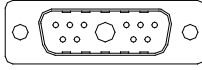
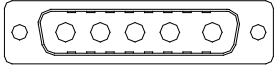
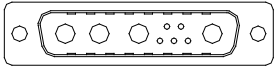
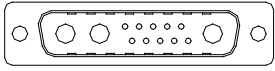
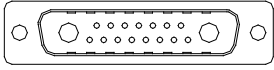
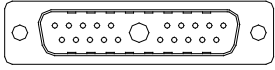
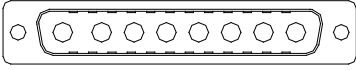
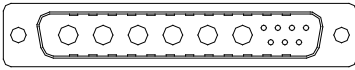
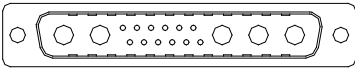
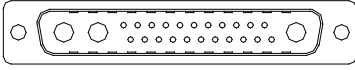
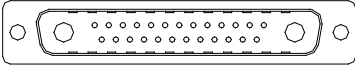
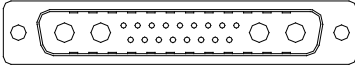
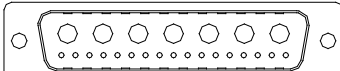
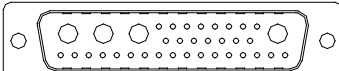
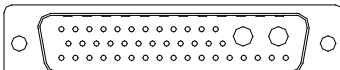
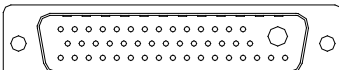
	POWER/COAXIAL D-SUB ONLY	COMBINATION
SIZE 9	 2W2  2WK2	 5W1
SIZE 15	 3W3  3WK3	 7W2  11W1
SIZE 25	 5W5	 9W4  13W3  17W2  21W1
SIZE 37	 8W8	 13W6  17W5  25W3  27W2  21W4
SIZE 50		 24W7  36W4  43W2  47W1

### Power/Coaxial D-SUB:

#### R/A PCB SOLDER TYPE

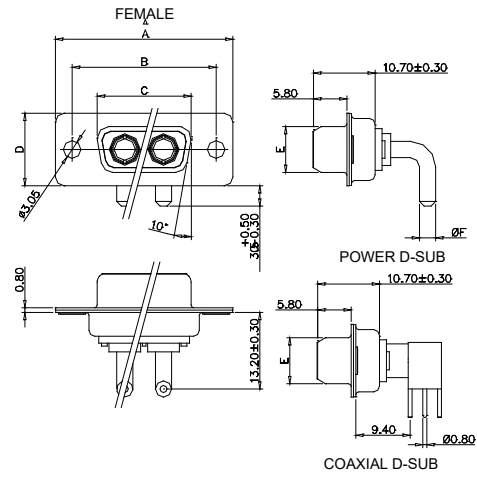
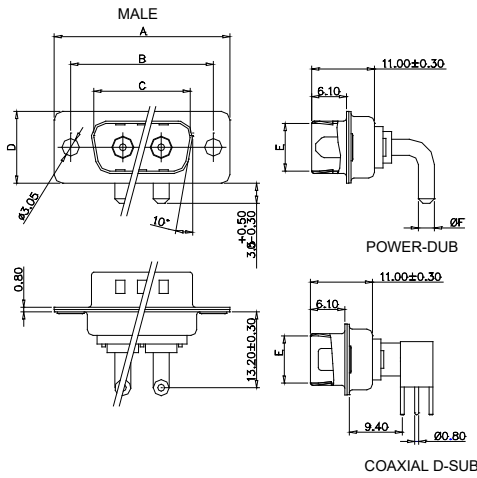

POWER D-SUB							
CONTACT SHELL SIZE	DIMA	DIMB	DIMC	DIMD	DIME(POWER/COAXIAL)	RATING	ØF
SIZE 9	30.80	25.00	16.90	12.50	7.90/8.30	10A	1.7
SIZE 15	39.20	33.30	25.25	12.50	7.90/8.30	20A	2.8
SIZE 25	53.05	47.05	38.95	12.50	7.90/8.30	30A	3.2
SIZE 37	69.40	63.50	55.40	12.50	7.90/8.30	40A	3.75
COAXIAL D-SUB							

POWER D-SUB							
CONTACT SHELL SIZE	DIMA	DIMB	DIMC(POWER/COAXIAL)	DIMD	DIME	RATING	ØF
SIZE 9	30.80	25.00	16.90/16.30	12.50	7.90	10A	1.7
SIZE 15	39.20	33.30	25.25/24.60	12.50	7.90	20A	2.8
SIZE 25	53.05	47.05	38.95/38.40	12.50	7.90	30A	3.2
SIZE 37	69.40	63.50	55.40/54.80	12.50	7.90	40A	3.75
COAXIAL D-SUB							

#### MOUNTING OPTION

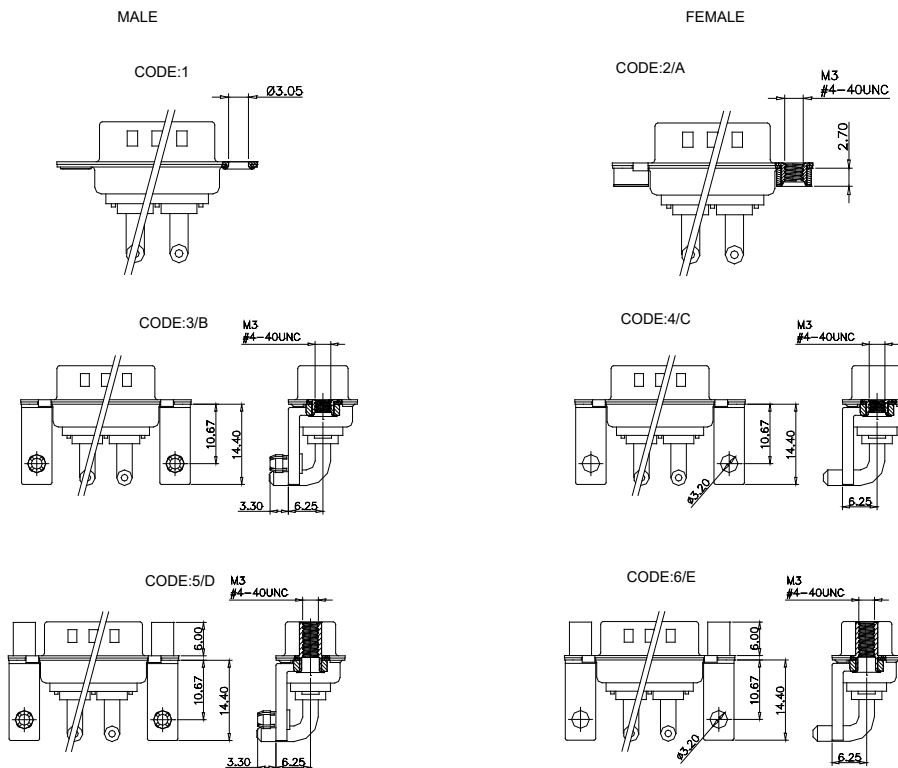

### Power D-SUB:

### PCB LAYOUT FOR POWER D-SUB MALE AND FEMALE CONNECTOR

CODE:2W2/2WK2

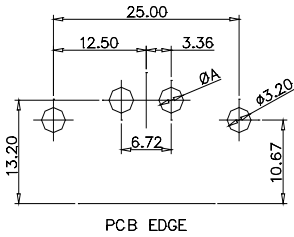

CODE:3W3/3WK3

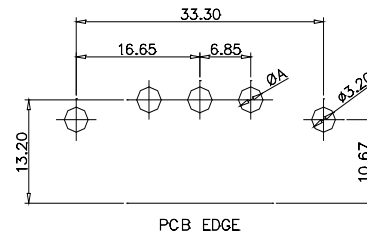

CODE:5W5 MALE

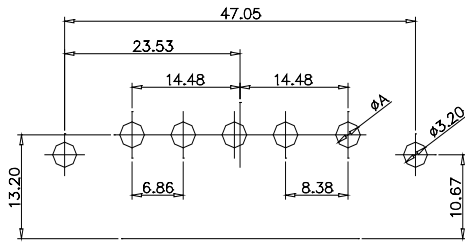

CODE:8W8 MALE

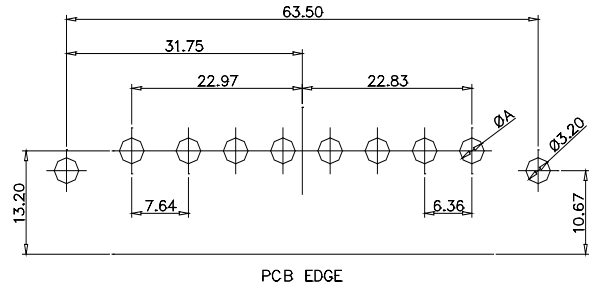

CODE:5W5 FEMALE

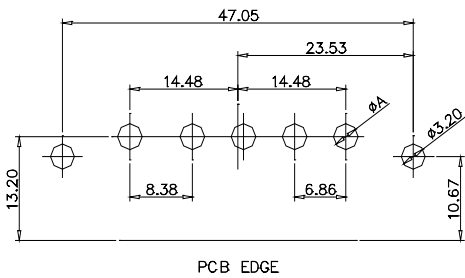

CODE:8W8 FEMALE

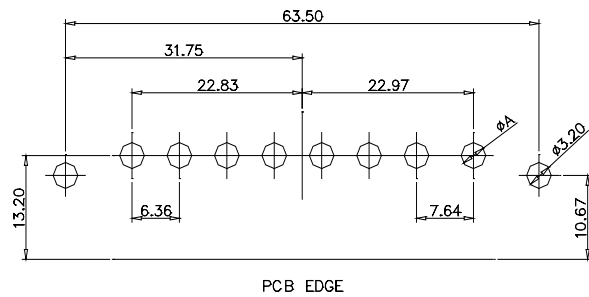

CURRENT RATING	10A	20A	30A	40A
ØA(mm)	2.2	3.3	3.7	4.2

### Coaxial D-SUB:

### PCB LAYOUT FOR COAXIAL D-SUB MALE AND FEMALE CONNECTOR

CODE:2W2/2WK2  
MALE/FEMALE

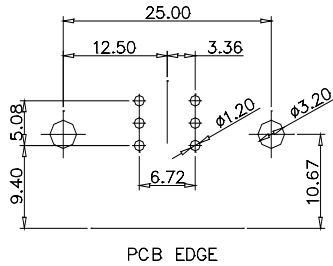

CODE:3W3/3WK3  
MALE/FEMALE

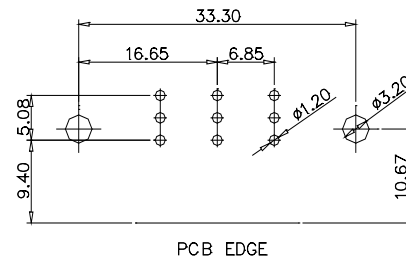

CODE:5W5  
MALE

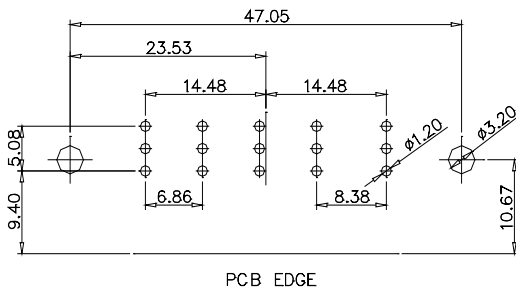

CODE:8W8  
MALE

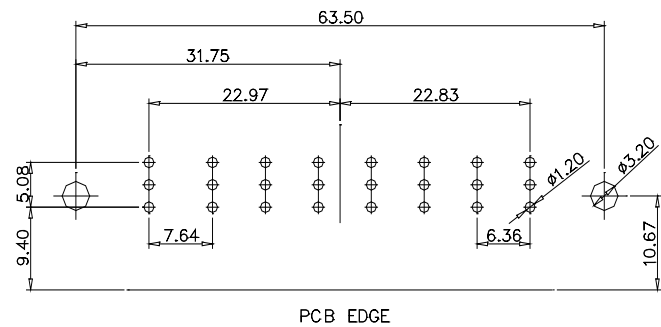

CODE:5W5  
FEMALE

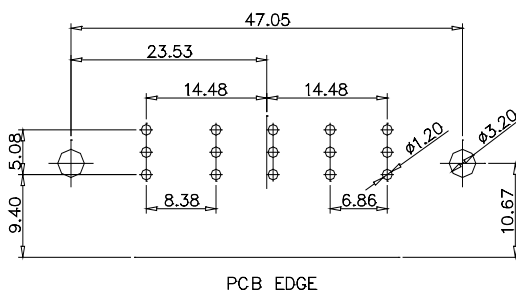

CODE:8W8  
FEMALE

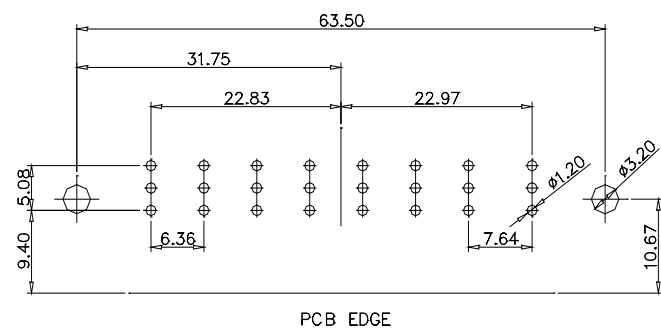

### Power Combo & Coaxial Combo D-SUB:

#### RA PCB SOLDER TYPE

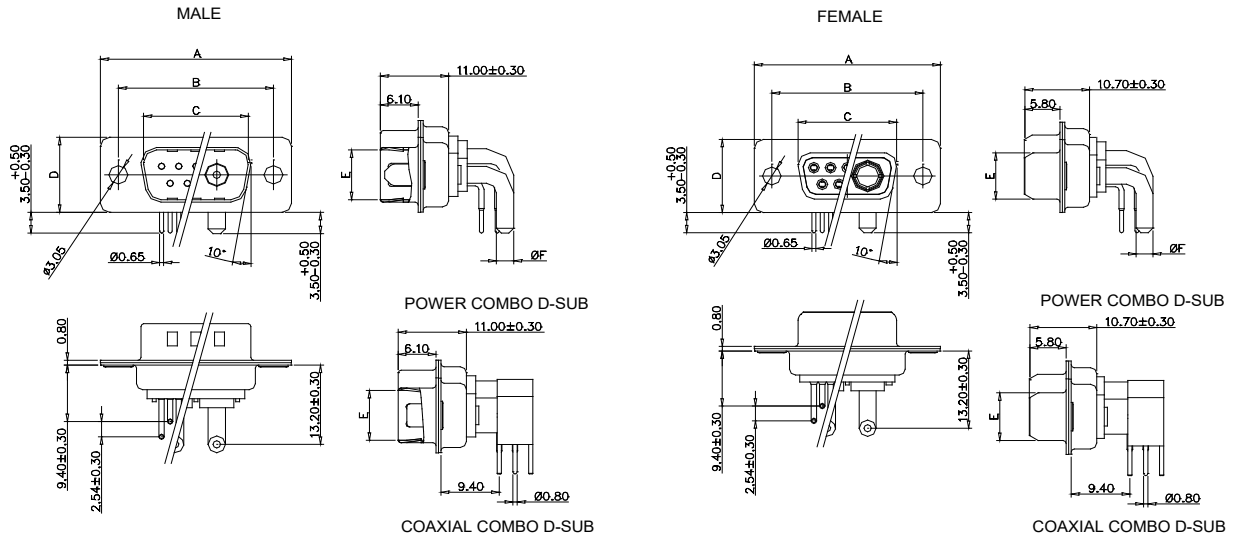

CONTACT SHELL SIZE	POWER D-SUB						
	DIMA	DIMB	DIMC	DIMD	DIME	RATING	ØF
SIZE 9	30.80	25.00	16.90	12.50	8.30	10A	1.7
SIZE 15	39.20	33.30	25.25	12.50	8.30	20A	2.8
SIZE 25	53.05	47.05	38.95	12.50	8.30	30A	3.2
SIZE 37	69.40	63.50	55.40	12.50	8.30	40A	3.75
SIZE 50	67.00	61.00	52.80	15.30	11.15		

CONTACT SHELL SIZE	POWER D-SUB						
	DIMA	DIMB	DIMC	DIMD	DIME	RATING	ØF
SIZE 9	30.80	25.00	16.30	12.50	7.90	10A	1.7
SIZE 15	39.20	33.30	24.60	12.50	7.90	20A	2.8
SIZE 25	53.05	47.05	38.40	12.50	7.90	30A	3.2
SIZE 37	69.40	63.50	55.40	12.50	7.90	40A	3.75
SIZE 50	67.00	61.00	52.20	15.30	10.90		

#### R/A PCB SOLDER TYPE MOUNTING OPTION

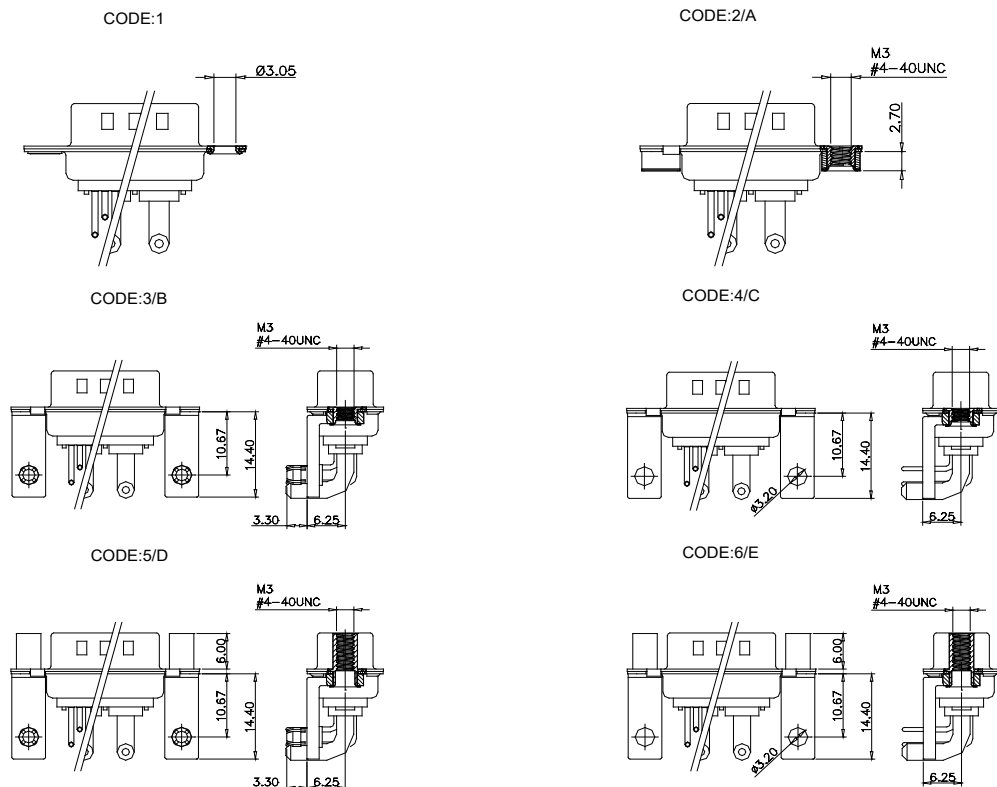

### Power Combo D-SUB:

### PCB LAYOUT FOR MALE AND FEMALE CONNECTOR

CODE:5W1  
MALE/FEMALE

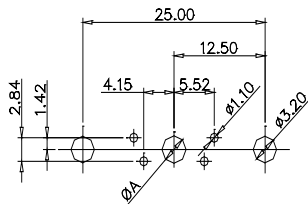

CODE:7W2  
MALE/FEMALE

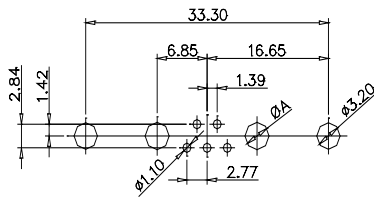

CODE:11W1  
MALE/FEMALE

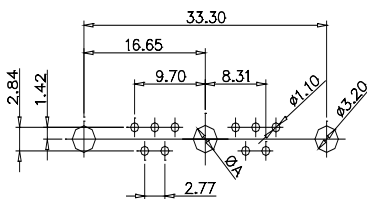

CODE:17W2  
MALE/FEMALE

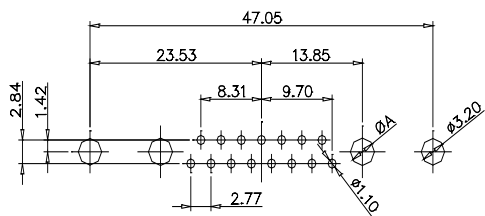

CODE:24W7  
MALE/FEMALE

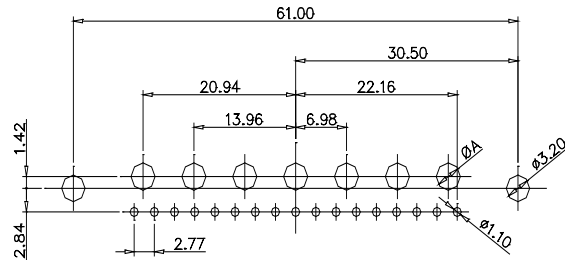

CODE:21W4  
MALE/FEMALE

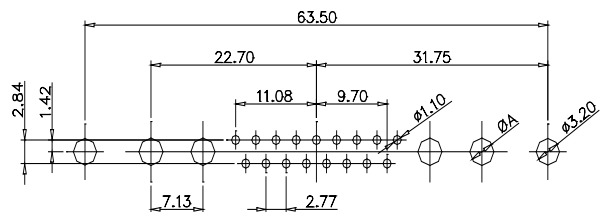

CODE:27W2  
MALE/FEMALE

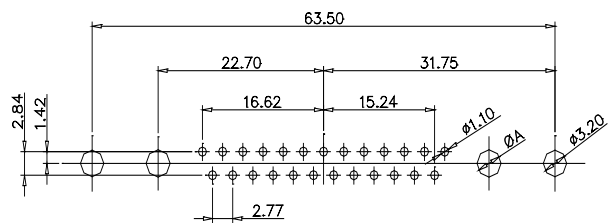

CODE:21W1  
MALE/FEMALE

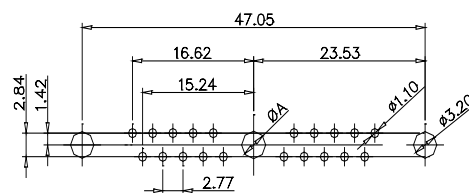

CURRENT RATING	10A	20A	30A	40A
ØA(mm)	2.2	3.3	3.7	4.2

### Power Combo D-SUB:

#### PCB LAYOUT FOR MALE CONNECTOR

CODE:9W4  
MALE

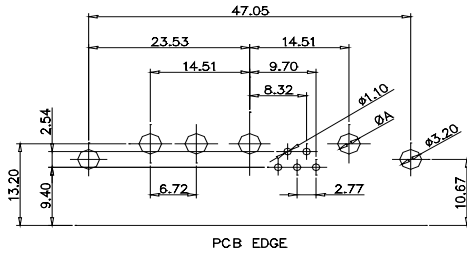

CODE:25W3  
MALE

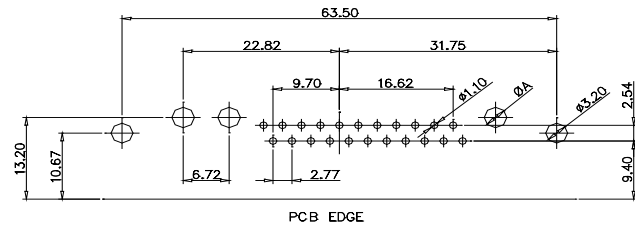

CODE:13W3  
MALE

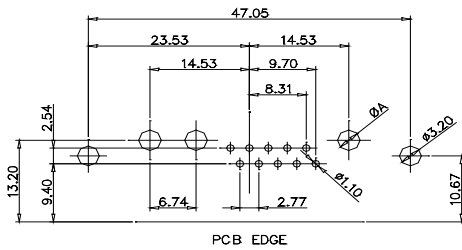

CODE:36W4  
MALE

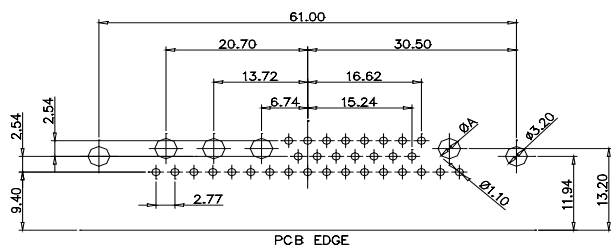

CODE:13W6  
MALE

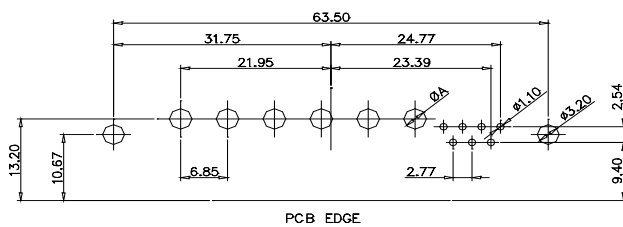

CODE:43W2  
MALE

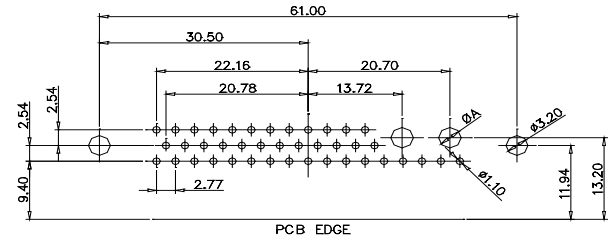

CODE:17W5  
MALE

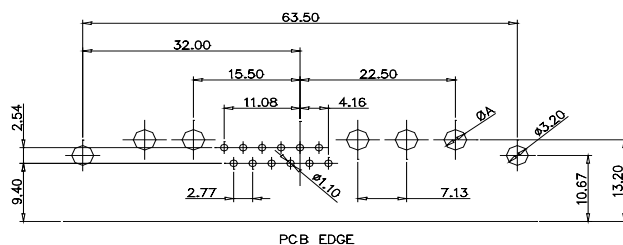

CODE:47W1  
MALE

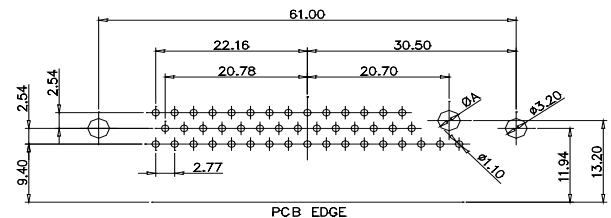

CURRENT RATING	10A	20A	30A	40A
ØA(mm)	2.2	3.3	3.7	4.2



### Power Combo D-SUB:

#### PCB LAYOUT FOR FEMALE CONNECTOR

CODE:9W4  
FEMALE

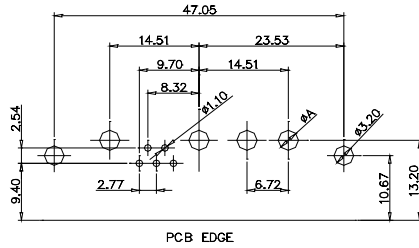

CODE:25W3  
FEMALE

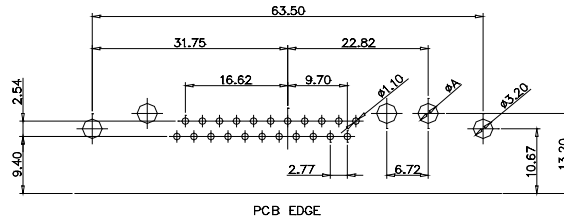

CODE:13W3  
FEMALE

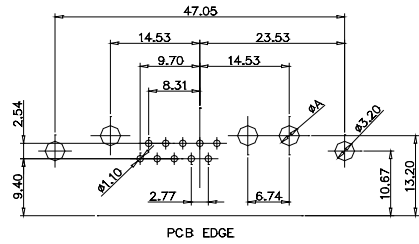

CODE:36W4  
FEMALE

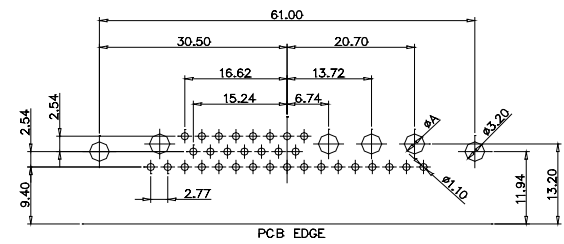

CODE:13W6  
FEMALE

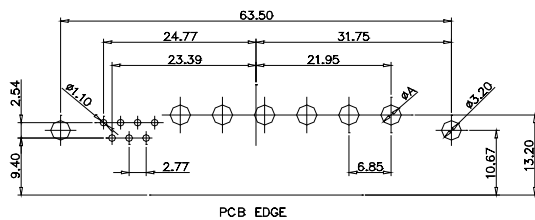

CODE:43W2  
FEMALE

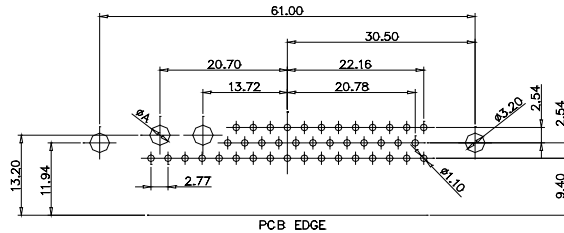

CODE:17W5  
FEMALE

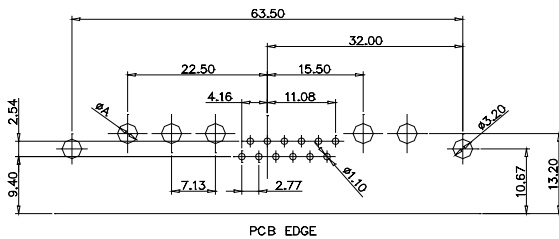

CODE:47W1  
FEMALE

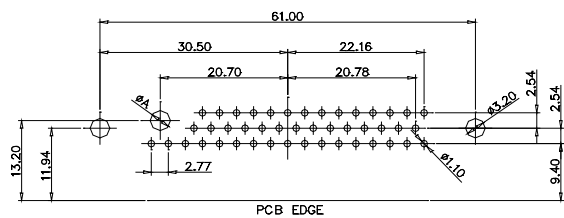

CURRENT RATING	10A	20A	30A	40A
ØA(mm)	2.2	3.3	3.7	4.2

### Coaxial Combo D-SUB:

### PCB LAYOUT FOR MALE AND FEMALE CONNECTOR

CODE:5W1  
MALE/FEMALE

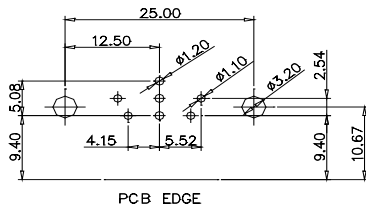

CODE:24W7  
MALE/FEMALE

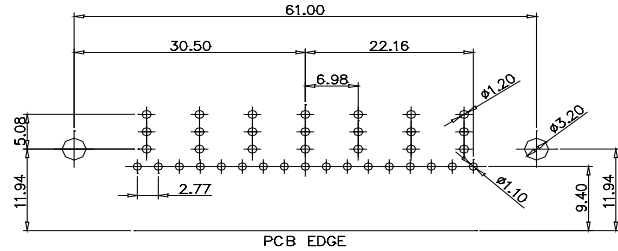

CODE:7W2  
MALE/FEMALE

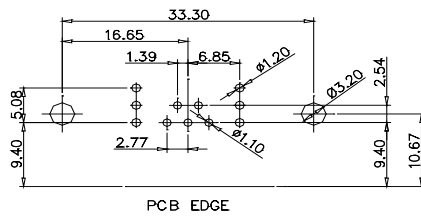

CODE:21W4  
MALE/FEMALE

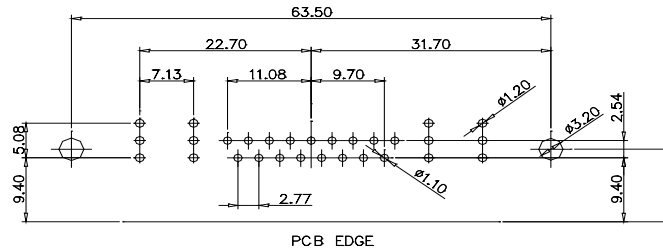

CODE:11W1  
MALE/FEMALE

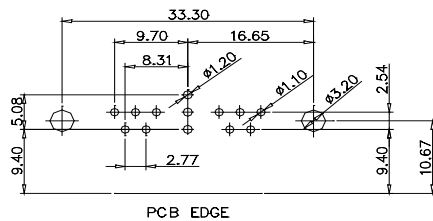

CODE:27W2  
MALE/FEMALE

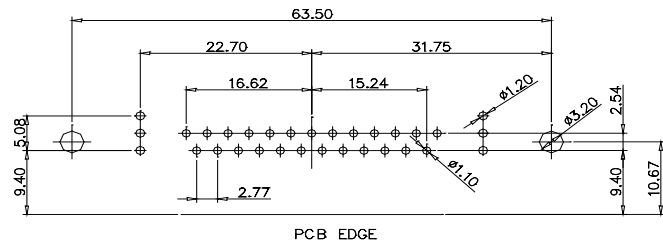

CODE:17W2  
MALE/FEMALE

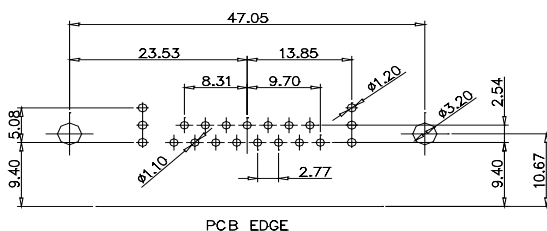

CODE:21W1  
MALE/FEMALE

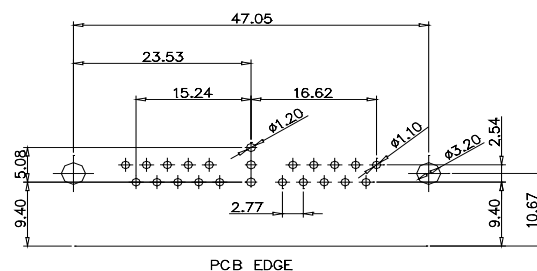

## Power Combo D-Sub Connectors: Right Angle

### Coaxial Combo D-SUB:

### PCB LAYOUT FOR MALE CONNECTOR

CODE:9W4  
MALE

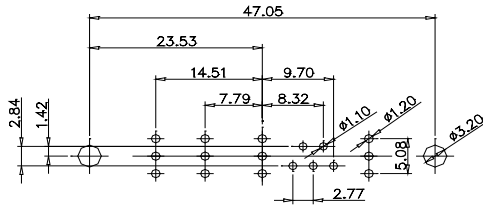

CODE:25W3  
MALE

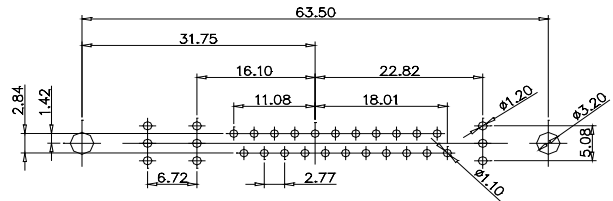

CODE:13W3  
MALE

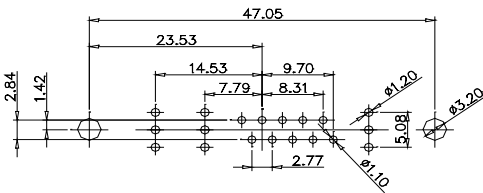

CODE:36W4  
MALE

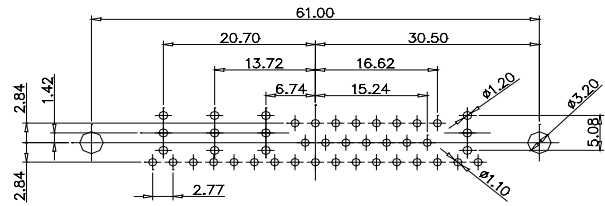

CODE:13W6  
MALE

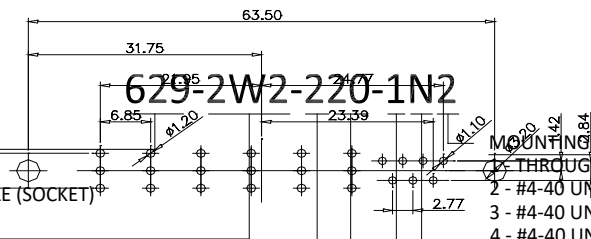

CODE:43W2  
MALE

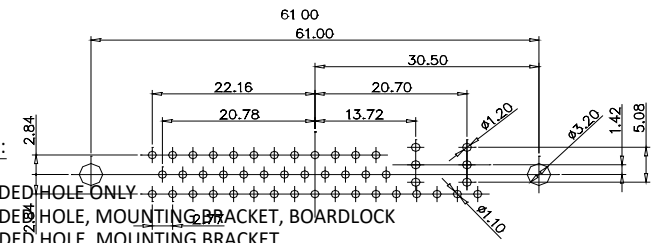

SERIES:  
629: PLUG (PIN)  
630: RECEPTACLE (SOCKET)

LAYOUT:

	POWER/CO-AX ONLY		COMBINATION			
	2W2	2WK2	5W1			
SIZE 9 CONTACT SHELL						
SIZE 15 CONTACT SHELL	3W3	3WK3	7W2	11W1		
SIZE 25 CONTACT SHELL	5W5		9W4	13W3	17W5	
SIZE 37 CONTACT SHELL	8W8		13W6	17W5	21W2	21W4
SIZE 50 CONTACT SHELL			24W7	36W4	43W2	47W1

8W8  
2WK2  
63.50  
31.75  
22.70  
11.08  
2.77  
7.13  
2.77  
7.13

CONTACT PLATING THICKNESS:  
2 - GOLD FLASH PLATING  
6 - 30 MICRONS OF GOLD PLATING

TAIL TYPE:  
40 - PC TAIL  
50 - PC TAIL 20.33mm FOOTPRINT (POWER CONTACT ONLY)

**MOUNTING OPTIONS:**

- 1 - THROUGH HOLE
- 2 - #4-40 UNC THREADED HOLE ONLY
- 3 - #4-40 UNC THREADED HOLE, MOUNTING BRACKET, BOARDLOCK
- 4 - #4-40 UNC THREADED HOLE, MOUNTING BRACKET
- 5 - #4-40 UNC THREADED STANDOFF, MOUNTING BRACKET, BOARDLOCK
- 6 - #4-40 UNC THREADED STANDOFF, MOUNTING BRACKET
- A - M3 THREADED HOLE ONLY
- B - M3 THREADED HOLE, MOUNTING BRACKET, BOARDLOCK
- C - M3 THREADED HOLE, MOUNTING BRACKET CODE:47W1
- D - M3 THREADED STANDOFF, MOUNTING BRACKET, BOARDLOCK
- E - M3 THREADED STANDOFF, MOUNTING BRACKET

SHELL PLATING:  
N - NICKEL  
T - TIN

RATING:  
POWER CONTACT  
CURRENT RATING:  
1 - 10A  
2 - 20A  
3 - 30A  
4 - 40A

COAXIAL CONTACT  
IMPEDANCE RATING:  
5 - 50 OHMS  
7 - 75 OHMS

### Coaxial Combo D-SUB:

### PCB LAYOUT FOR FEMALE CONNECTOR

CODE:9W4  
FEMALE

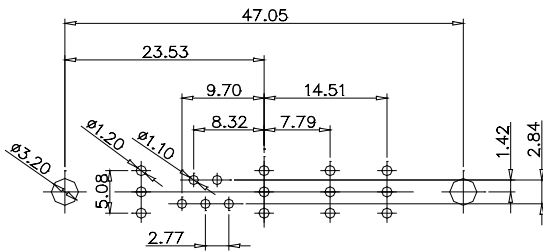

CODE:25W3  
FEMALE

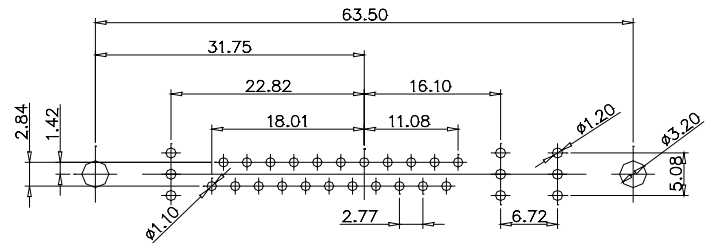

CODE:13W3  
FEMALE

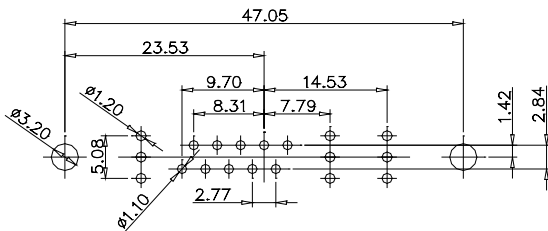

CODE:36W4  
FEMALE

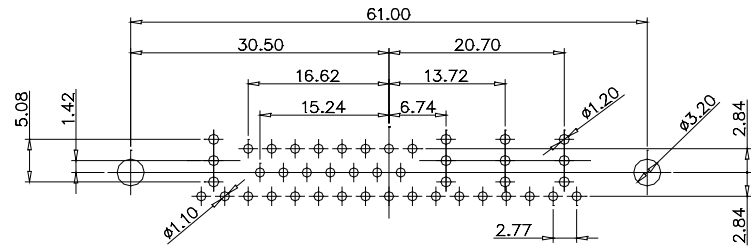

CODE:13W6  
FEMALE

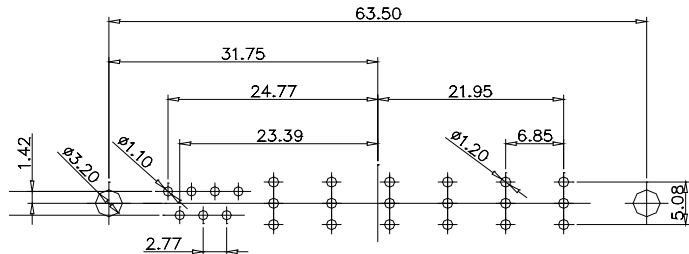

CODE:43W2  
FEMALE

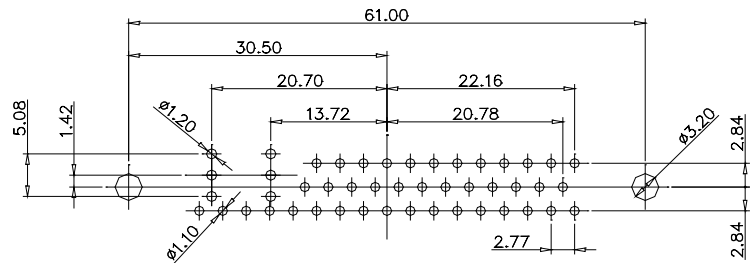

CODE:17W5  
FEMALE

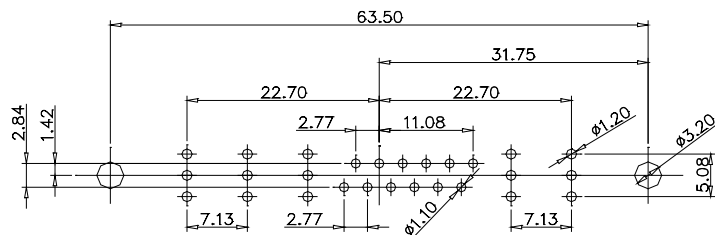

CODE:47W1  
FEMALE

