

# 346/396 SERIES



## Card Edge Connectors 0.125" (3.175mm) Pitch

### Features:

- 0.100" (2.54mm) contact spacing x 0.200" (5.08mm) row spacing
- Accepts 0.062" (1.57mm) nominal thickness P.C. board
- High profile insulator body, 0.600" (15.24mm)
- Contact termination options include P.C. tail, wire wrap, 90 degree bends and extender board bends
- Single or dual row configurations
- Large variety of mounting options, flush or offset lugs
- Accepts between contact and in-contact polarizing keys
- Pre-assembled card guides are available
- Automatic wire wrap positioning holes
- RoHS Compliant & UL Certified

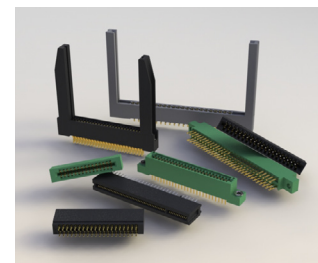

### Specifications:

Insulator Material	UL 94V-0 Thermoplastic Polyester
Contact Material	Copper Alloy
Contact Plating	Gold Plating on mating area and Tin Plating on tails with Nickel underplating all over
Current Rating	3 amps
Contact Resistance	10 milliohms maximum
Dielectric Withstanding Voltage	1500 V AC rms at sea level between adjacent contacts
Insulation Resistance	5000 megaohms minimum
Operating Temperature	-40°C to +105°C
Insertion Force	16 oz (4.45 N) maximum per contact pair when tested with .070" (1.78mm) thick gauge
Withdrawal Force	1 oz (0.28 N) minimum per contact pair when tested with .054" (1.37mm) thick gauge

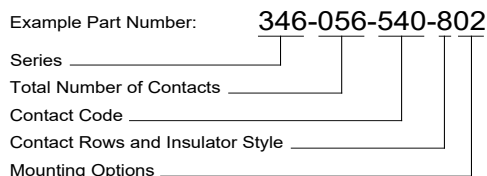

<b>Series:</b>	<b>Insulator Color:</b>	
346	Thermoplastic Polyester, Green	
396	Thermoplastic Polyester, Black	
<b>Total Number of Contacts:</b>	<b>Contact Rows:</b>	
005, 006, . . . . 050	Single Row	
010, 012, . . . . 100	Dual Row	
<b>Insulator Style:</b>	<b>Description:</b>	<b>Insulator Style</b>
1	Single Row	Flush Mounting Lugs
2	Dual Row	Flush Mounting Lugs
6	Single Row	.170 (4.32) Offset Lugs
8	Dual Row	.170 (4.32) Offset Lugs
<b>Mounting Options:</b>	<b>Description:</b>	
01	No Mounting Lug	
02	Ø.128" (Ø3.25mm) Mounting Holes	
03	Ø.116" (Ø2.95mm) I.D. Floating Eyelets	
04	Ø.156" (Ø3.96mm) Mounting Holes	
07	M3-0.5 Metric Threaded Inserts	
08	#4-40 Unified Threaded Inserts	
12	Ø.128" (Ø3.25mm) Side Mounting Holes	
58	.468" (11.89mm) Offset Card Guides	
78	In-Line Card Guides 2.750" (69.85mm) Long	

Contact Code:	Tail Description:	Tail Size:	Tail Length "G":
500	Wire Hole	.050 x .025 (1.27 x 0.64)	.260 (6.60)
520	P.C. Tail	.025 Square (0.64 Square)	.175 (4.45)
521	P.C. Tail	.025 Square (0.64 Square)	.150 (3.81)
522	P.C. Tail	.025 Square (0.64 Square)	.440 (11.18)
526	P.C. Tail	.025 Square (0.64 Square)	.150 (3.81)
540	Wire Wrap	.025 Square (0.64 Square)	.560 (14.22)
541	Wire Wrap	.025 Square (0.64 Square)	.750 (19.05)
555	EXTENDER BOARD BEND	(CODE 500 CONTACTS)	
556	EXTENDER BOARD BEND	(CODE 520 CONTACTS)	
558	90 DEGREE BEND	(CODE 541 CONTACTS)	
559	90 DEGREE BEND	(CODE 541 CONTACTS)	
560	EXTENDER BOARD BEND	(Code 526 Contacts)	

#### Ordering Code Notes:

- 1) All connector sizes up to 50 contacts single row / 100 contacts dual row are available upon request.
- 2) The 500 contact code is only available in the 346 series. Green Diallyl Phthalate insulator material will be supplied.
- 3) For details of the extender board and 90 degree bends refer to next pages.
- 4) Consult with EDAC Inc. regarding connectors with a .420" (10.67mm) card slot depth.
- 5) For lug-less connectors, code 01 mounting, specify contact row code 1 or 2.
- 6) In-line card guides are only available with offset mounting lugs.
- 7) For details of the mounting options refer to page 3.

## Card Edge Connectors 0.125" (3.175mm) Pitch

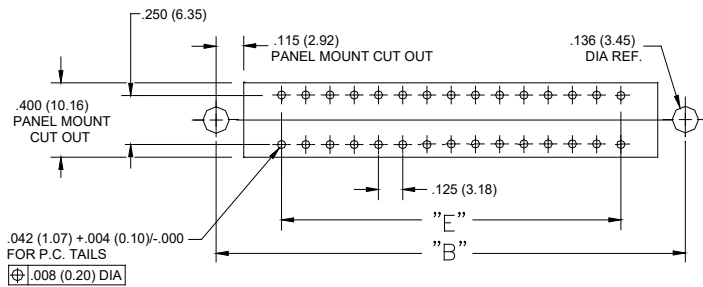
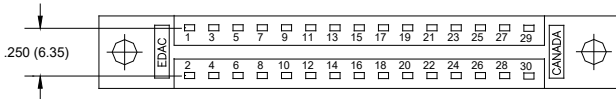
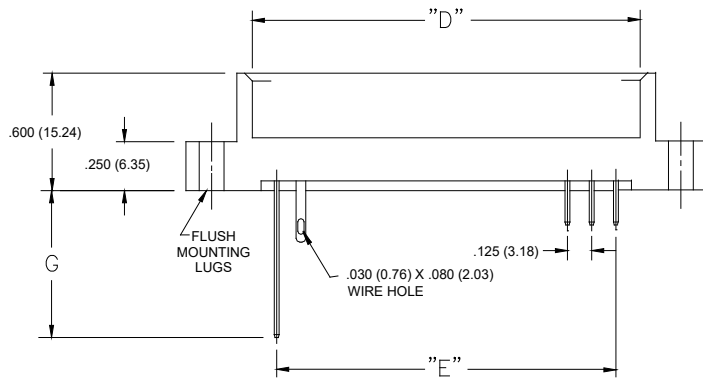
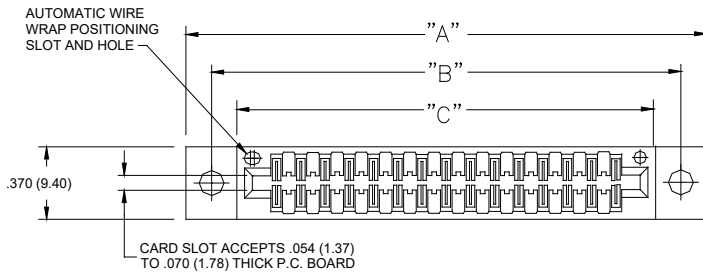

CONNECTOR MOUNTING PATTERN

### IN-CONTACT POLARIZING KEY

P/N 345-240-328



### BETWEEN CONTACT POLARIZING KEY

P/N 306-240-318

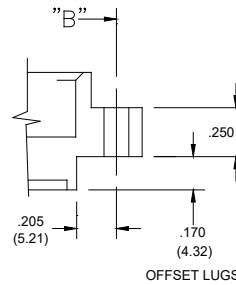
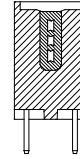

### SECTIONS THROUGH CONTACT POSITION

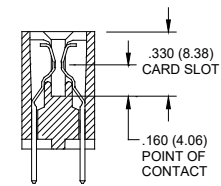

### DUAL ROW

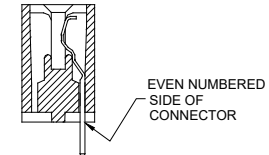

### SINGLE ROW

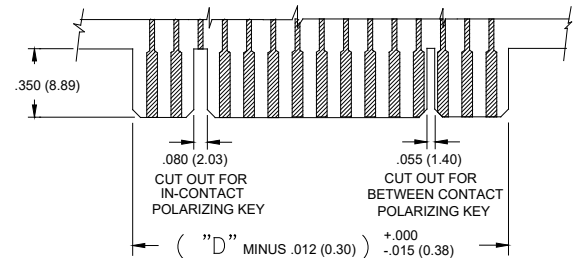

RECOMMENDED DAUGHTER BOARD

NUMBER OF CONTACTS		"A"		"B"		"C"		"D"		"E"	
Single	Double	Inch	mm	Inch	mm	Inch	mm	Inch	mm	Inch	mm
5	10	1.435	36.45	1.170	29.72	0.910	23.11	1.435	36.45	0.500	12.70
6	12	1.560	39.62	1.295	32.89	1.035	26.29	1.560	39.62	0.625	15.88
10	20	2.060	52.32	1.795	45.59	1.535	38.99	2.060	52.32	1.125	28.58
15	30	2.685	68.20	2.420	61.47	2.160	54.86	2.685	68.20	1.750	44.45
18	36	3.060	77.72	2.795	70.99	2.535	64.39	3.060	77.72	2.125	53.98
22	44	3.560	90.42	3.295	83.69	3.035	77.09	3.560	90.42	2.625	66.68
25	50	3.935	99.95	3.670	93.22	3.410	86.61	3.935	99.95	3.000	76.20
30	60	4.560	115.82	4.295	109.09	4.035	102.49	4.560	115.82	3.625	92.08
31	62	4.685	119.00	4.420	112.27	4.160	105.66	4.685	119.00	3.750	95.25
35	70	5.185	131.70	4.920	124.97	4.660	118.36	5.185	131.70	4.250	107.95
36	72	5.310	134.87	5.045	128.14	4.785	121.54	5.310	134.87	4.375	111.13
40	80	5.810	147.57	5.545	140.84	5.285	134.24	5.810	147.57	4.875	123.83
43	86	6.185	157.10	5.920	150.37	5.660	143.76	6.185	157.10	5.250	133.35
50	100	7.060	179.32	6.795	172.59	6.535	165.99	7.060	179.32	6.125	155.58

## Card Edge Connectors 0.125" (3.175mm) Pitch

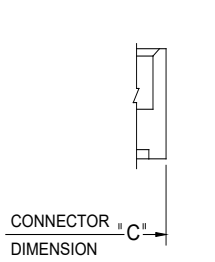

MOUNTING OPTION  
CODE x01  
(NO MOUNTING LUGS)

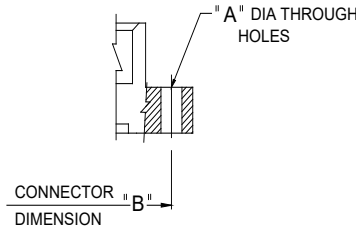

MOUNTING OPTION  
CODES x02 AND x04  
(THROUGH MOUNTING HOLES)

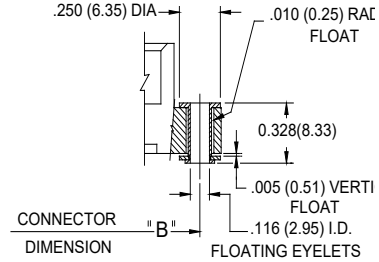

MOUNTING OPTION  
CODE x03  
(FLOATING EYELETS)

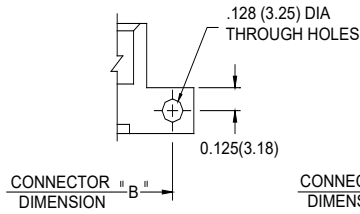

MOUNTING OPTION  
CODE x12  
(SIDE MOUNTING HOLES)  
WITH INSERTS: CODES X17 & X18,  
SEE TABLE

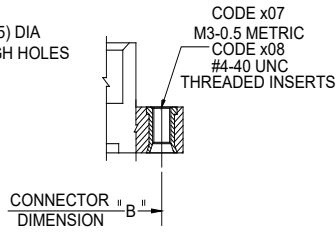

MOUNTING OPTION  
CODES x07 & x08  
(THREADED INSERTS)

CODE X02 AND X04- THROUGH MTG. HOLES		
	CODE X02	CODE X04
"A" DIA.	0.128(3.25)	0.156(3.96)
CODE X07 AND X08- THREADED INSERTS		
	CODE X07	CODE X08
INSERT	M3-0.5(METRIC)	#4-40 UNC
SIDE MOUNTING HOLES WITH INSERTS		
	CODE X17	CODE X18
INSERT	M3-0.5(METRIC)	#4-40 UNC
CODE X78 - IN-LINE CARD GUIDES		
	CODE X78	
"A"	2.750(69.85)	

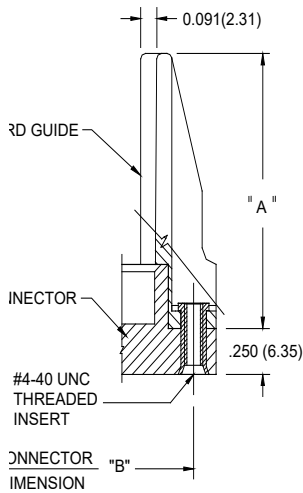

MOUNTING OPTION  
CODE x78  
(IN-LINE CARD GUIDE)

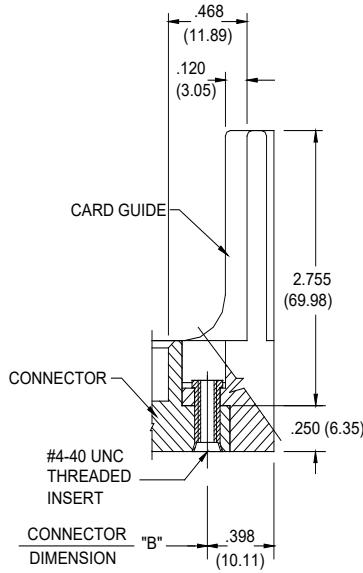

MOUNTING OPTION  
CODES x58  
(OFFSET CARD GUIDES)

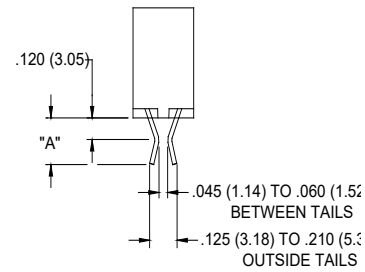

CONTACT CODE 555 BEND USES  
WIRE HOLE CONTACTS

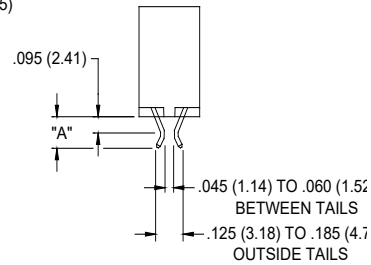

CONTACT CODE 556

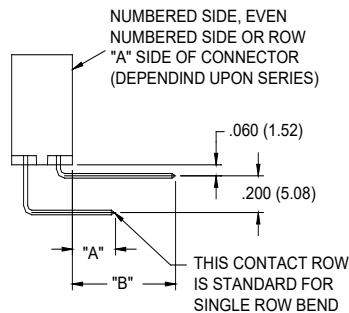

CONTACT CODE 558

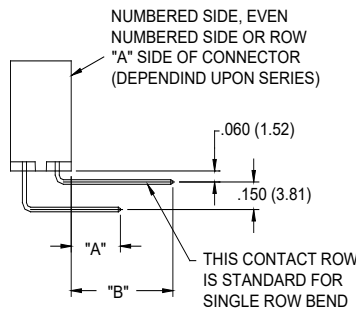

CONTACT CODE 559

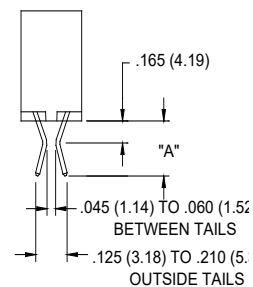

CONTACT CODE 560