

Features

Unregulated Converters

- Qualified with 65kV/μs @ Vcommon mode =1KV
- EN61010 for test, measurement and lab use
- EN60601 for medical applications
- Reinforced isolation 6.4kVDC or 8kVDC
- Optional continuous short circuit protection
- Unique reinforced isolation transformer system
- /X2 option for >9mm input/output clearance



RxxPxx/R

1 Watt
SIP7
Single and Dual Output



Description

The RxxPxx_D Series of DC/DC Converters are certified to UL/CSA60950-1. This makes them ideal for safety applications where approved or reinforced isolation is required. The reinforced versions are also EN61010-1 certified for Lab Equipment Safety.

Selection Guide

Part Number	nom. Input Voltage [VDC]	Output Voltage [VDC]	Output Current [mA]	Efficiency typ. (1) [%]	max. Capacitive Load (2) [μF]
RxxP3.3S/R ^(3,4,5)	5, 12, 15, 24	3.3	303	70 - 80	2200
RxxP05S/R ^(3,4,5)	5, 12, 15, 24	5	200	75 - 80	1000
RxxP09S/R ^(3,4,5)	5, 12, 15, 24	9	111	75 - 82	1000
RxxP12S/R ^(3,4,5)	5, 12, 15, 24	12	84	75 - 82	470
RxxP15S/R ^(3,4,5)	5, 12, 15, 24	15	66	75 - 83	470
RxxP3.3D/R ^(3,4,5)	5, 12, 15, 24	±3.3	±151	72 - 79	±1000
RxxP05D/R ^(3,4,5)	5, 12, 15, 24	±5	±100	75 - 82	±470
RxxP09D/R ^(3,4,5)	5, 12, 15, 24	±9	±55	75 - 82	±470
RxxP12D/R ^(3,4,5)	5, 12, 15, 24	±12	±41	75 - 82	±220
RxxP15D/R ^(3,4,5)	5, 12, 15, 24	±15	±33	75 - 83	±220

Notes:

- Note1: Efficiency is tested at nominal input and full load at +25°C ambient
 Note2: Max. Capacitive Load is defined as the capacitive load that will allow start up in under 1 second without damage to the converter

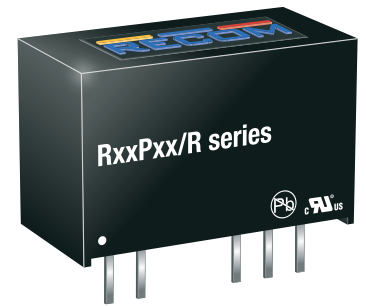

Model Numbering

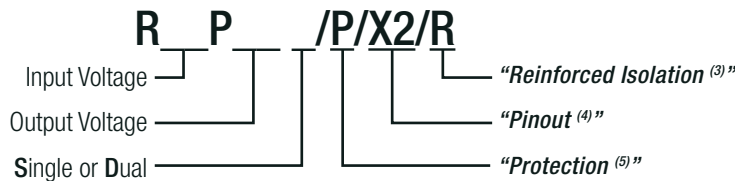

Notes:

- Note3: add suffix „/R6.4“ for 6.4kVDC/1second isolation or „/R8“ for 8kVDC/1second isolation
 Note4: add suffix „/X2“ for single output with alternative pinout
 Note5: add suffix „/P“ for continuous short circuit protection

Ordering Examples:

R05P3.3S/R8/P = 5V Input, 3.3V Output, Single Output, 8kVDC/1s isolation, Continuous Short Circuit Protection
 R24P05S/R6.4/P/X2 = 24V Input, 5V Output, Single Output, 6.4kVDC/1s isolation, Continuous SCP, Alternative Pinout
 R12P05D/R8/X2 = ±12V Input, ±5V Output, Dual Output, 8kVDC/1s isolation, Alternative Pinout

UL/CSA60950-1 certified
 IEC/EN60950-1 certified
 UL/ES/CSA60601-1 certified
 IEC/EN60601-1 certified
 IEC/EN61010-1 certified
 CB report



www.recom-power.com/eval-ref-boards

www.recom-power.com/bier

Specifications (measured @ Ta= 25°C, nom. Vin, full load and after warm-up unless otherwise stated)

BASIC CHARACTERISTICS

Parameter	Condition	Min.	Typ.	Max.
Input Voltage Range			±10%	
Minimum Load			0%	
Internal Operating Frequency		20kHz	50kHz	85kHz
Output Ripple and Noise	20MHz BW			200mVp-p

Efficiency vs. Load

RxxP05S/R6.4 and RxxP05S/R8

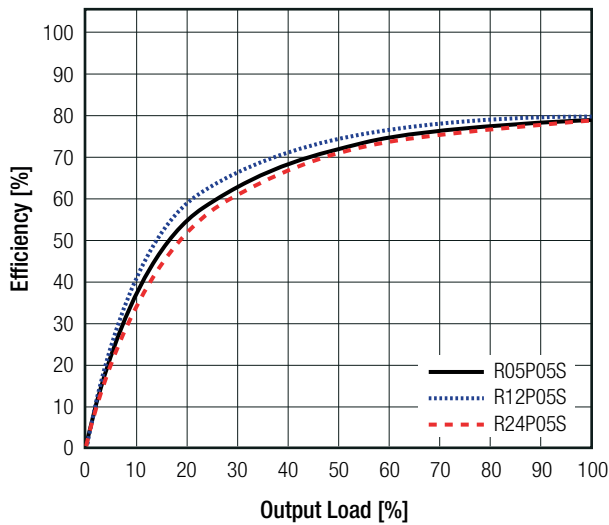

RxxP05D/R6.4 and RxxP05D/R8

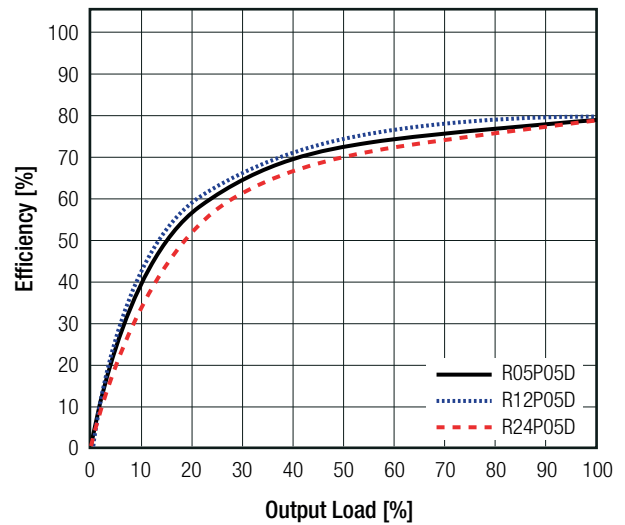

REGULATIONS

Parameter	Condition		Value
Output Accuracy			±5.0% max.
Line Regulation	low line to high line, full load		1.2%/1% of Vin typ.
Load Regulation ⁽⁶⁾	10% to 100% load	3.3Vout, 5Vout	15% typ.
		9Vout, 12Vout, 15Vout	10% typ.

Notes:

Note6: Operation below 10% load will not harm the converter, but specifications may not be met

Tolerance Envelope

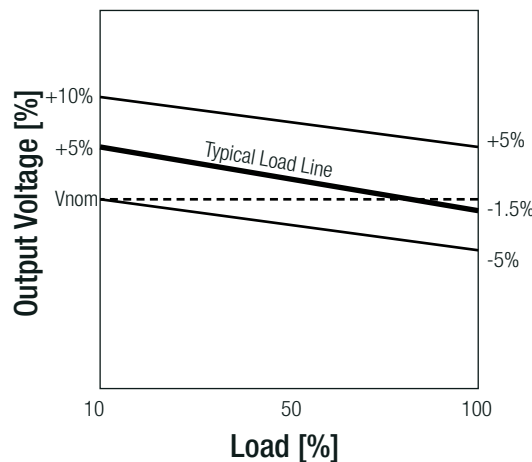

continued on next page

Specifications (measured @ Ta= 25°C, nom. Vin, full load and after warm-up unless otherwise stated)

Deviation vs. Load

RxxP05S/R6.4 and RxxP09S/R8

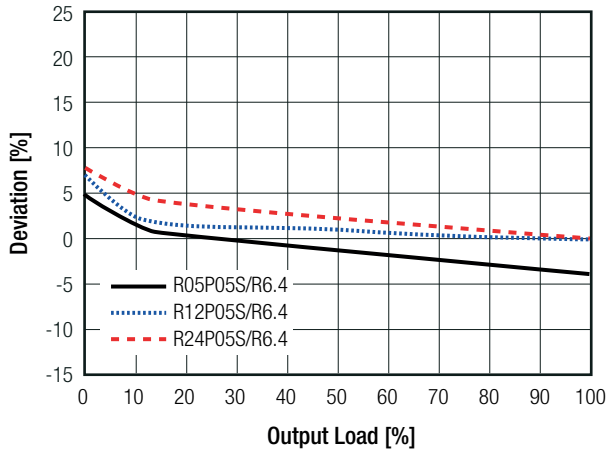

RxxP05D/R6.4 and RxxP09D/R8

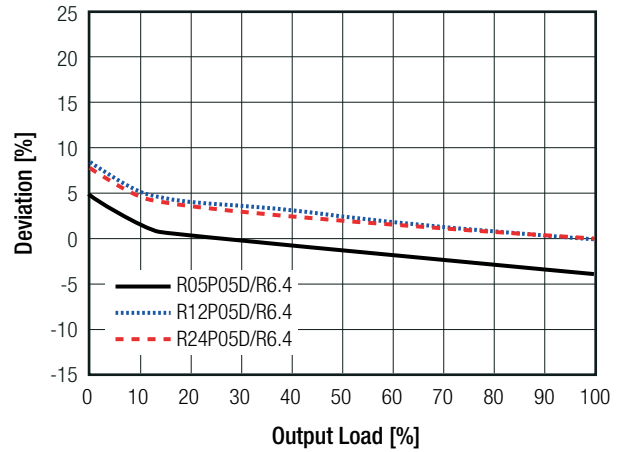

PROTECTIONS

Parameter	Type		Value
Short Circuit Protection (SCP)	without Suffix "/P" with Suffix "/P"		1 second continuous
Isolation Voltage ⁽⁷⁾	I/P to O/P	tested for 1 second	"/R6.4" 8kVDC "/R8" 8kVDC
		rated for 1 minute	"/R6.4" 3.2kVAC/60Hz "/R8" 4kVAC/60Hz
Isolation Resistance			15GΩ min.
Isolation Capacitance			4.0pF min. / 10pF max.
Leakage Current			<0.01μA max.
Insulation Grade			reinforced
Means of Protection	34Vrms		2MOPP
Internal	clearance/creepage		>4.8mm
External	clearance/creepage		>4.8mm

Notes:

Note7: For repeat Hi-Pot testing, reduce the time and/or the test voltage

ENVIRONMENTAL

Parameter	Condition	Value
Operating Temperature Range	without derating @ free air convection (see graph)	-40°C to +85°C
Maximum Case Temperature		+105°C
Operating Altitude		3000m
Operating Humidity	non-condensing	95% RH max.
Pollution Degree		PD2
MTBF	according to MIL-HDBK-217F, G.B.	+25°C 2974 x 10 ³ hours
		+85°C 728 x 10 ³ hours

continued on next page

Specifications (measured @ Ta= 25°C, nom. Vin, full load and after warm-up unless otherwise stated)

Derating Graph

(@ Chamber and free air convection)

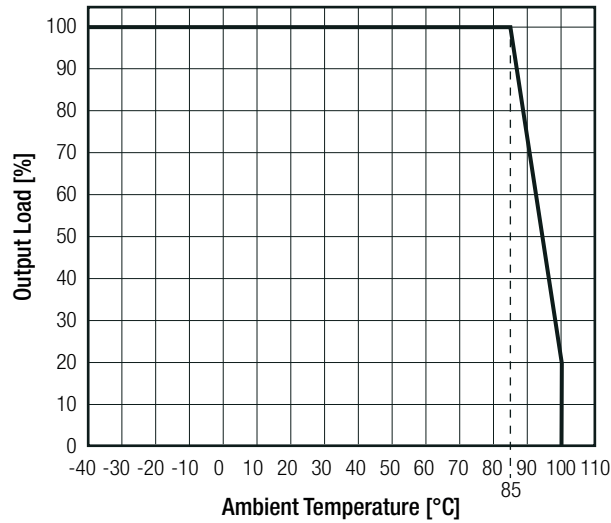

SAFETY AND CERTIFICATIONS

Certificate Type (Safety)	Report / File Number	Standard
Information Technology Equipment, General Requirements for Safety	LVD1605077-14	EN60950-1: 2006 + A2:2013 IEC60950-1-2005 , 2nd Edition + A2:2013
Information Technology Equipment, General Requirements for Safety	2236395	ANSI/UL60950-1, 1st Edition CAN/CSA-C22.2 No. 60950-1
Information Technology Equipment, General Requirements for Safety	2207629	ANSI/UL60950-1, 1st Edition CAN/CSA C22.2 No. 60950-1
Medical Electric Equipment, General Requirements for Safety and Essential Performance	2207629	UL60601-1, 1st Edition CAN/CSA-C22.2 No. 601.1-M90
Medical Electric Equipment, General Requirements for Safety and Essential Performance	E314885-A5-UL	ANSI/AAMI ES60601-1:2005 + A2:10 CAN/CSA-C22.2 No. 60601-1:2008
Medical Electric Equipment, General Requirements for Safety and Essential Performance. (CB Scheme)	E314885-A5-CB-1	IEC60601-1:2005 + C2:2007
Medical Electric Equipment, General Requirements for Safety and Essential Performance	WD-SE-R-180539-A0	EN60601-1:2006 + A12:2014 IEC60601-1:2005 + A1:2012, 3rd Edition
Safety requirements for electrical equipment for measurement, control and laboratory use	T1301251-313	EN61010:2010 IEC61010:2010, 3rd Edition
EAC	RU-AT.37.02367	TP TC 004/2011
RoHS 2		RoHS-2011/65/EU + AM-2015/863
EMC Compliance	Condition	Standard / Criterion
Electromagnetic compatibility of multimedia equipment - Emission requirements	with external filter (refer to „EMC Filtering“)	EN55032, Class A and B

continued on next page

Specifications (measured @ Ta= 25°C, nom. Vin, full load and after warm-up unless otherwise stated)

EMC Filtering Suggestion according to EN55032 Class A and Class B

Class A

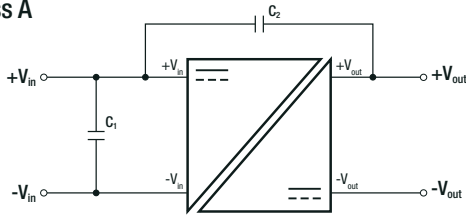

Class B

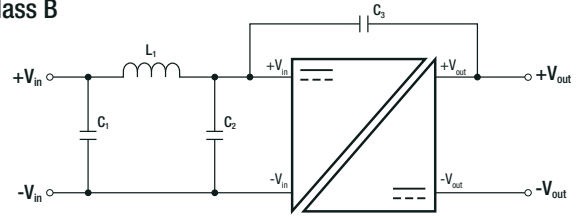

Component List Class A

Model	C1	C2
RxxPxx/R6.4	10µF	2n2F 8kV
RxxPxx/R8	10µF	2n5F 10kV

Component List Class B

Model	C1	L1	C2	C3
RxxPxx/R6.4	10µF	470µH WE 7447471471	10µF	2n2F 8kV
RxxPxx/R8	10µF	470µH WE 7447471471	10µF	2n5F 10kV

DIMENSION AND PHYSICAL CHARACTERISTICS

Parameter	Type	Value
Material	case potting PCB	non-conductive black plastic, (UL94 V-0) silicon rubber compound, (UL94 V-0) FR4, (UL94 V-0)
Dimension (LxWxH)		19.5 x 9.8 x 12.5mm
Weight		4.3g typ.

Dimension Drawing (mm)

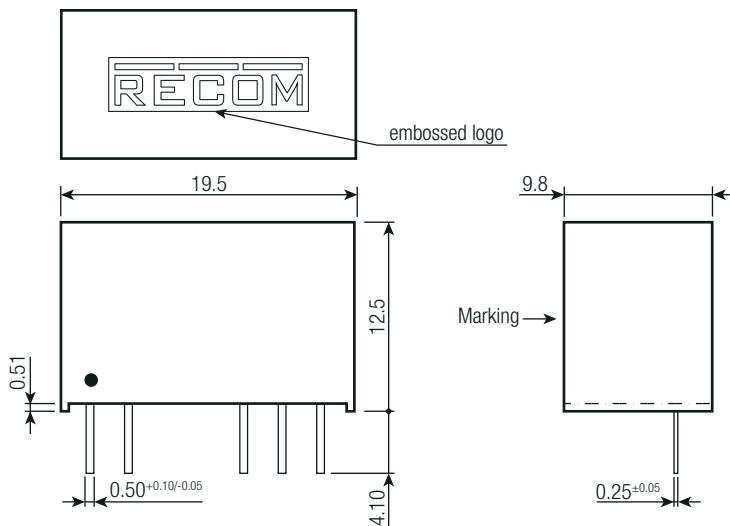
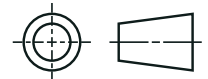

Pin Connection

Pin #	Single	Dual	/X2
1	+Vin	+Vin	+Vin
2	-Vin	-Vin	-Vin
5	-Vout	-Vout	No Pin
6	No Pin	Com	-Vout
7	+Vout	+Vout	+Vout

Tolerance: xx.x= ±0.5mm
xx.xx= ±0.25mm

Recommended Footprint Details

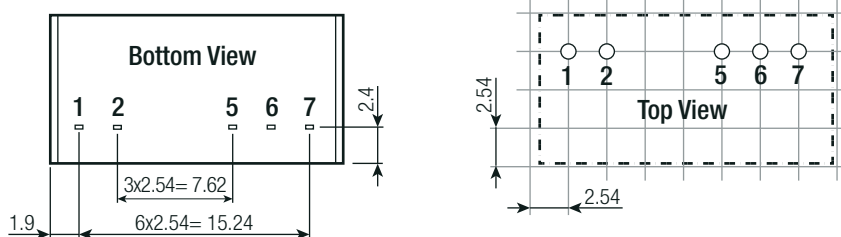

Specifications (measured @ Ta= 25°C, nom. Vin, full load and after warm-up unless otherwise stated)

PACKAGING INFORMATION		
Parameter	Type	Value
Packaging Dimension (LxWxH)	tube	520.0 x 22.3 x 12.0mm
Packaging Quantity	tube	25pcs
Storage Temperature Range		-55°C to +125°C
Storage Humidity		95% RH max.

The product information and specifications may be subject to changes even without prior written notice. The product has been designed for various applications; its suitability lies in the responsibility of each customer. The products are not authorized for use in safety-critical applications without RECOM's explicit written consent. A safety-critical application is an application where a failure may reasonably be expected to endanger or cause loss of life, inflict bodily harm or damage property. The applicant shall indemnify and hold harmless RECOM, its affiliated companies and its representatives against any damage claims in connection with the unauthorized use of RECOM products in such safety-critical applications.