

## Reference Specification

Type SA

Safety Standard Certified Lead Type Disc Ceramic Capacitors for General Purpose

Product specifications in this catalog are as of Jun. 2023, and are subject to change or obsolescence without notice.  
Please consult the approval sheet before ordering. Please read rating and Cautions first.

**⚠ CAUTION****1. OPERATING VOLTAGE**

1) Do not apply a voltage to a safety standard certified product that exceeds the rated voltage as called out in the specifications. Applied voltage between the terminals of a safety standard certified product shall be less than or equal to the rated voltage (+10 %). When a safety standard certified product is used as a DC voltage product, the AC rated voltage value becomes the DC rated voltage value.

(Example: AC250 V (r.m.s.) rated product can be used as DC250 V (+10 %) rated product.)

If both AC rated voltage and DC rated voltage are specified, apply the voltage lower than the respective rated voltage.

1-1) When a safety standard certified product is used in a circuit connected to a commercial power supply, ensure that the applied commercial power supply voltage including fluctuation should be less than 10 % above its rated voltage.

1-2) When using a safety standard certified product as a DC rated product in circuits other than those connected to a commercial power supply.

When AC voltage is superimposed on DC voltage, the zero-to-peak voltage shall not exceed the rated DC voltage. When AC voltage or pulse voltage is applied, the peak-to-peak voltage shall not exceed the rated DC voltage.

Typical Voltage Applied to the DC Capacitor

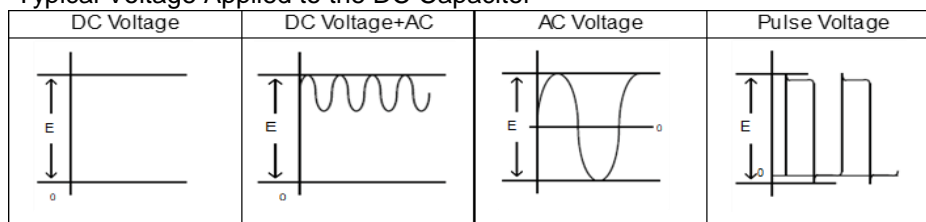

(E: Maximum possible applied voltage.)

2) Abnormal voltages (surge voltage, static electricity, pulse voltage, etc.) shall not exceed the rated DC voltage.

**2. OPERATING TEMPERATURE AND SELF-GENERATED HEAT**

Keep the surface temperature of a capacitor below the upper limit of its rated operating temperature range. Be sure to take into account the heat generated by the capacitor itself.

When the capacitor is used in a high-frequency current, pulse current or the like, it may have the self-generated heat due to dielectric-loss. Applied voltage should be the load such as self-generated heat is within 20 °C on the condition of atmosphere temperature 25 °C. When measuring, use a thermocouple of small thermal capacity-K of  $\Phi 0.1$  mm and be in the condition where capacitor is not affected by radiant heat of other components and wind of surroundings. Excessive heat may lead to deterioration of the capacitor's characteristics and reliability. (Never attempt to perform measurement with the cooling fan running. Otherwise, accurate measurement cannot be ensured.)

**3. TEST CONDITION FOR WITHSTANDING VOLTAGE****1) TEST EQUIPMENT**

Test equipment for AC withstanding voltage should be used with the performance of the wave similar to 50/60 Hz sine wave.

If the distorted sine wave or over load exceeding the specified voltage value is applied, the defective may be caused.

## 2) VOLTAGE APPLIED METHOD

When the withstanding voltage is applied, capacitor's lead or terminal should be firmly connected to the out-put of the withstanding voltage test equipment, and then the voltage should be raised from near zero to the test voltage.

If the test voltage without the raise from near zero voltage would be applied directly to capacitor, test voltage should be applied with the \*zero cross. At the end of the test time, the test voltage should be reduced to near zero, and then capacitor's lead or terminal should be taken off the out-put of the withstanding voltage test equipment.

If the test voltage without the raise from near zero voltage would be applied directly to capacitor, the surge voltage may arise, and therefore, the defective may be caused.

\*ZERO CROSS is the point where voltage sine wave pass 0 V.

- See the right figure -

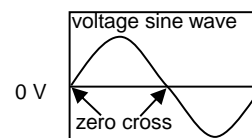

## 4. FAIL-SAFE

When capacitor would be broken, failure may result in a short circuit. Be sure to provide an appropriate fail-safe function like a fuse on your product if failure would follow an electric shock, fire or fume.

## 5. VIBRATION AND IMPACT

Do not expose a capacitor or its leads to excessive shock or vibration during use.

## 6. SOLDERING

When soldering this product to a PCB/PWB, do not exceed the solder heat resistance specification of the capacitor. Subjecting this product to excessive heating could melt the internal junction solder and may result in thermal shocks that can crack the ceramic element.

When soldering capacitor with a soldering iron, it should be performed in following conditions.

Temperature of iron-tip	: 400 °C max.
Soldering iron wattage	: 50 W max.
Soldering time	: 3.5 s max.

## 7. BONDING, RESIN MOLDING AND COATING

In case of bonding, molding or coating this product, verify that these processes do not affect the quality of capacitor by testing the performance of the bonded, molded or coated product in the intended equipment.

In case of the amount of applications, dryness / hardening conditions of adhesives and molding resins containing organic solvents (ethyl acetate, methyl ethyl ketone, toluene, etc.) are unsuitable, the outer coating resin of a capacitor is damaged by the organic solvents and it may result, worst case, in a short circuit.

The variation in thickness of adhesive, molding resin or coating may cause a outer coating resin cracking and/or ceramic element cracking of a capacitor in a temperature cycling.

## 8. TREATMENT AFTER BONDING, RESIN MOLDING AND COATING

When the outer coating is hot (over 100 °C) after soldering, it becomes soft and fragile.

So please be careful not to give it mechanical stress.

Failure to follow the above cautions may result, worst case, in a short circuit and cause fuming or partial dispersion when the product is used.

## 9. OPERATING AND STORAGE ENVIRONMENT

The insulating coating of capacitors does not form a perfect seal; therefore, do not use or store capacitors in a corrosive atmosphere, especially where chloride gas, sulfide gas, acid, alkali, salt or the like are present. And avoid exposure to moisture. Before cleaning, bonding, or molding this product, verify that these processes do not affect product quality by testing the performance of a cleaned, bonded or molded product in the intended equipment. Store the capacitors where the temperature and relative humidity do not exceed -10 to 40 °C and 15 to 85 %.

Use capacitors within 6 months after delivered. Check the solderability after 6 months or more.

## 10. LIMITATION OF APPLICATIONS

Please contact us before using our products for the applications listed below which require especially high reliability for the prevention of defects which might directly cause damage to the third party's life, body or property.

1. Aircraft equipment
2. Aerospace equipment
3. Undersea equipment
4. Power plant control equipment
5. Medical equipment
6. Transportation equipment (vehicles, trains, ships, etc.)
7. Traffic signal equipment
8. Disaster prevention / crime prevention equipment
9. Data-processing equipment exerting influence on public
10. Application of similar complexity and/or reliability requirements to the applications listed in the above.

## NOTICE

### 1. CLEANING (ULTRASONIC CLEANING)

To perform ultrasonic cleaning, observe the following conditions.

Rinse bath capacity : Output of 20 watts per liter or less.

Rinsing time : 5 min maximum.

Do not vibrate the PCB/PWB directly.

Excessive ultrasonic cleaning may lead to fatigue destruction of the lead wires.

### 2. CAPACITANCE CHANGE OF CAPACITORS

- Class 1 capacitors

Capacitance might change a little depending on a surrounding temperature or an applied voltage.

Please contact us if you use for the strict time constant circuit.

- Class 2 and 3 capacitors

Class 2 and 3 capacitors like temperature characteristic B, E and F have an aging characteristic, whereby the capacitor continually decreases its capacitance slightly if the capacitor leaves for a long time. Moreover, capacitance might change greatly depending on a surrounding temperature or an applied voltage. So, it is not likely to be able to use for the time constant circuit.

Please contact us if you need a detail information.

### 3. PERFORMANCE CHECK BY EQUIPMENT

Before using a capacitor, check that there is no problem in the equipment's performance and the specifications.

Generally speaking, CLASS 2 ceramic capacitors have voltage dependence characteristics and temperature dependence characteristics in capacitance. So, the capacitance value may change depending on the operating condition in a equipment. Therefore, be sure to confirm the apparatus performance of receiving influence in a capacitance value change of a capacitor, such as leakage current and noise suppression characteristic.

Moreover, check the surge-proof ability of a capacitor in the equipment, if needed, because the surge voltage may exceed specific value by the inductance of the circuit.

 **NOTE**

1. Please make sure that your product has been evaluated in view of your specifications with our product being mounted to your product.
2. You are requested not to use our product deviating from this specification.

1.Application

This specification is applied to Safety Standard Certified Lead Type Disc Ceramic Capacitors Type SA used for General Electric equipment.

The safety standard certification is obtained by Class X1, Y2.

Do not use these products in any automotive power train or safety equipment including battery chargers for electric vehicles and plug-in hybrids.

Approval standard and certified number

	Standard number	*Certified number	Rated voltage
UL/cUL	UL60384-14/CSA E60384-14	E37921	X1: AC440 V(r.m.s.) Y2: AC400 V(r.m.s.)
ENEC (VDE)	EN60384-14	40042990	
CQC	IEC60384-14	CQC15001137840	

\*Above Certified number may be changed on account of the revision of standards and the renewal of certification.

2.Rating

2-1.Operating temperature range

-40 ~ 125°C

2-2.Rated Voltage

X1: AC440 V(r.m.s.)

Y2: AC400 V(r.m.s.)

DC1,500 V

2-3.Part number configuration

ex.)

DE2	E3	SA	103	M	A3	B	Y02F
Series	Temperature Characteristics	Certified Type	Capacitance	Capacitance Tolerance	Lead Style	Package	Individual Specification

• Series

DE2 denotes class X1,Y2.

• Temperature Characteristics

Please confirm detailed specification on [Specification and test methods].

Code	Temperature Characteristics
1X	SL
B3	B
E3	E

• Certified Type

This denotes safety certified type name Type SA.

• Capacitance

The first two digits denote significant figures ; the last digit denotes the multiplier of 10 in pF.

ex.) In case of 103 .

$$10 \times 10^3 = 10000 \text{ pF}$$

• Capacitance Tolerance

Please refer to [ Part number list ].

## • Lead Style

\* Please refer to [ Part number list ].

Code	Lead Style
A*	Vertical crimp long type
J*	Vertical crimp short type
N*	Vertical crimp taping type

## • Package

Code	Package
A	Ammo pack taping type
B	Bulk type

## • Individual Specification

For part number that cannot be identified without "Individual Specification", it is added at the end of part number.

Code	Individual Specification
Y02F	▶Rated voltage : X1: AC440 V(r.m.s.) Y2: AC400 V(r.m.s.) DC1,500 V ▶Halogen Free ( Br ≤ 900ppm, Cl ≤ 900ppm ) Br+Cl ≤ 1500ppm ▶CP wire ▶Dielectric strength between lead wires: AC2,600 V(r.m.s.)

Note) Murata part numbers might be changed depending on Lead Style or any other changes. Therefore, please specify only the Certified Type (SA) and capacitance of products in the parts list when it is required for applying safety standard of electric equipment.

## 3. Marking

Certified type	: SA
Capacitance	: Actual value(under 100 pF) 3 digit system(100 pF and over)
Capacitance tolerance	: Code
Class code and Rated voltage mark	: <b>X1 440~</b> <b>Y2 400~</b>
Manufacturing year	: Letter code(The last digit of A.D. year.)
Manufacturing month	: Code ( Feb./Mar. → 2      Aug./Sep. → 8 ) Apr./May → 4      Oct./Nov. → O Jun./Jul. → 6      Dec./Jan. → D )
Company name code	: <b>M15</b> (Made in Thailand)

(Example)

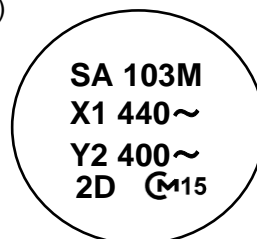

Reference only

4. Part number list

Vertical crimp long type  
(Lead Style: A\*)

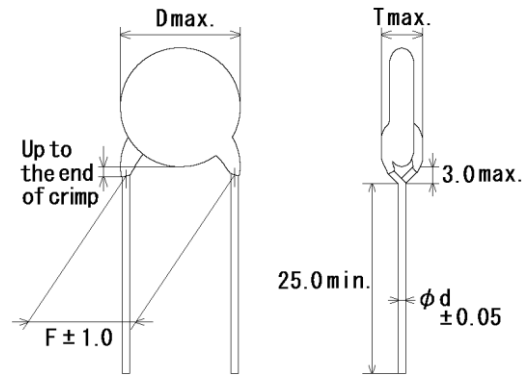

Note) The mark '\*' of Lead Style differ from lead spacing (F) and lead diameter (d).  
Please see the following list about details.

Unit : mm

Customer Part Number	Murata Part Number	T.C.	Cap. (pF)	Cap. tol.	Dimension (mm)				Lead Style	Pack qty. (pcs)
					D	T	F	d		
	DE21XSA100KA3BY02F	SL	10	±10%	7.0	5.0	7.5	0.6	A3	250
	DE21XSA150KA3BY02F	SL	15	±10%	6.0	6.0	7.5	0.6	A3	500
	DE21XSA220KA3BY02F	SL	22	±10%	6.0	5.0	7.5	0.6	A3	500
	DE21XSA330KA3BY02F	SL	33	±10%	7.0	5.0	7.5	0.6	A3	250
	DE21XSA470KA3BY02F	SL	47	±10%	7.0	5.0	7.5	0.6	A3	250
	DE21XSA680KA3BY02F	SL	68	±10%	9.0	5.0	7.5	0.6	A3	250
	DE2B3SA101KA3BY02F	B	100	±10%	6.0	5.0	7.5	0.6	A3	500
	DE2B3SA151KA3BY02F	B	150	±10%	6.0	5.0	7.5	0.6	A3	500
	DE2B3SA221KA3BY02F	B	220	±10%	6.0	6.0	7.5	0.6	A3	500
	DE2B3SA331KA3BY02F	B	330	±10%	6.0	5.0	7.5	0.6	A3	500
	DE2B3SA471KA3BY02F	B	470	±10%	7.0	5.0	7.5	0.6	A3	250
	DE2B3SA681KA3BY02F	B	680	±10%	8.0	5.0	7.5	0.6	A3	250
	DE2E3SA102MA3BY02F	E	1000	±20%	7.0	5.0	7.5	0.6	A3	250
	DE2E3SA152MA3BY02F	E	1500	±20%	8.0	5.0	7.5	0.6	A3	250
	DE2E3SA222MA3BY02F	E	2200	±20%	9.0	5.0	7.5	0.6	A3	250
	DE2E3SA332MA3BY02F	E	3300	±20%	12.0	5.0	7.5	0.6	A3	200
	DE2E3SA472MA3BY02F	E	4700	±20%	13.0	5.0	7.5	0.6	A3	200
	DE2E3SA103MA3BY02F	E	10000	±20%	17.0	6.0	7.5	0.6	A3	100



Reference only

-Vertical crimp short type  
(Lead Style: J\*)

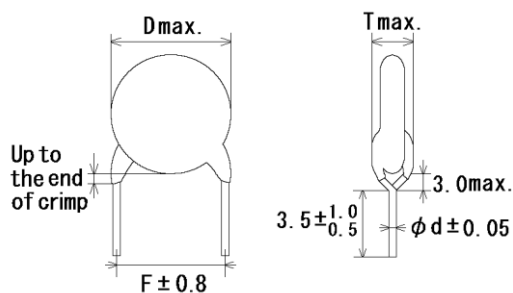

Note) The mark ' \* ' of Lead Style differ from lead spacing (F) and lead diameter (d).  
Please see the following list about details.

Unit : mm

Customer Part Number	Murata Part Number	T.C.	Cap. (pF)	Cap. tol.	Dimension (mm)				Lead Style	Pack qty. (pcs)
					D	T	F	d		
	DE21XSA100KJ3BY02F	SL	10	±10%	7.0	5.0	7.5	0.6	J3	500
	DE21XSA150KJ3BY02F	SL	15	±10%	6.0	6.0	7.5	0.6	J3	500
	DE21XSA220KJ3BY02F	SL	22	±10%	6.0	5.0	7.5	0.6	J3	500
	DE21XSA330KJ3BY02F	SL	33	±10%	7.0	5.0	7.5	0.6	J3	500
	DE21XSA470KJ3BY02F	SL	47	±10%	7.0	5.0	7.5	0.6	J3	500
	DE21XSA680KJ3BY02F	SL	68	±10%	9.0	5.0	7.5	0.6	J3	500
	DE2B3SA101KJ3BY02F	B	100	±10%	6.0	5.0	7.5	0.6	J3	500
	DE2B3SA151KJ3BY02F	B	150	±10%	6.0	5.0	7.5	0.6	J3	500
	DE2B3SA221KJ3BY02F	B	220	±10%	6.0	6.0	7.5	0.6	J3	500
	DE2B3SA331KJ3BY02F	B	330	±10%	6.0	5.0	7.5	0.6	J3	500
	DE2B3SA471KJ3BY02F	B	470	±10%	7.0	5.0	7.5	0.6	J3	500
	DE2B3SA681KJ3BY02F	B	680	±10%	8.0	5.0	7.5	0.6	J3	500
	DE2E3SA102MJ3BY02F	E	1000	±20%	7.0	5.0	7.5	0.6	J3	500
	DE2E3SA152MJ3BY02F	E	1500	±20%	8.0	5.0	7.5	0.6	J3	500
	DE2E3SA222MJ3BY02F	E	2200	±20%	9.0	5.0	7.5	0.6	J3	500
	DE2E3SA332MJ3BY02F	E	3300	±20%	12.0	5.0	7.5	0.6	J3	250
	DE2E3SA472MJ3BY02F	E	4700	±20%	13.0	5.0	7.5	0.6	J3	250
	DE2E3SA103MJ3BY02F	E	10000	±20%	17.0	6.0	7.5	0.6	J3	200

Vertical crimp taping type  
(Lead Style: N\*)

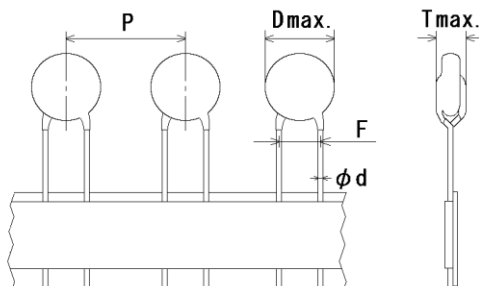

Note) The mark ' \* ' of Lead Style differ from lead spacing (F) ,  
lead diameter (d) and pitch of component (P).  
Please see the following list or taping specification about details.

Unit : mm

Customer Part Number	Murata Part Number	T.C.	Cap. (pF)	Cap. tol.	Dimension (mm)					Lead Style	Pack qty. (pcs)
					D	T	F	d	P		
	DE21XSA100KN3AY02F	SL	10	±10%	7.0	5.0	7.5	0.6	15.0	N3	900
	DE21XSA150KN3AY02F	SL	15	±10%	6.0	6.0	7.5	0.6	15.0	N3	900
	DE21XSA220KN3AY02F	SL	22	±10%	6.0	5.0	7.5	0.6	15.0	N3	900
	DE21XSA330KN3AY02F	SL	33	±10%	7.0	5.0	7.5	0.6	15.0	N3	900
	DE21XSA470KN3AY02F	SL	47	±10%	7.0	5.0	7.5	0.6	15.0	N3	900
	DE21XSA680KN3AY02F	SL	68	±10%	9.0	5.0	7.5	0.6	15.0	N3	900
	DE2B3SA101KN3AY02F	B	100	±10%	6.0	5.0	7.5	0.6	15.0	N3	900
	DE2B3SA151KN3AY02F	B	150	±10%	6.0	5.0	7.5	0.6	15.0	N3	900
	DE2B3SA221KN3AY02F	B	220	±10%	6.0	6.0	7.5	0.6	15.0	N3	900
	DE2B3SA331KN3AY02F	B	330	±10%	6.0	5.0	7.5	0.6	15.0	N3	900
	DE2B3SA471KN3AY02F	B	470	±10%	7.0	5.0	7.5	0.6	15.0	N3	900
	DE2B3SA681KN3AY02F	B	680	±10%	8.0	5.0	7.5	0.6	15.0	N3	900
	DE2E3SA102MN3AY02F	E	1000	±20%	7.0	5.0	7.5	0.6	15.0	N3	900
	DE2E3SA152MN3AY02F	E	1500	±20%	8.0	5.0	7.5	0.6	15.0	N3	900
	DE2E3SA222MN3AY02F	E	2200	±20%	9.0	5.0	7.5	0.6	15.0	N3	900
	DE2E3SA332MN3AY02F	E	3300	±20%	12.0	5.0	7.5	0.6	15.0	N3	900
	DE2E3SA472MN3AY02F	E	4700	±20%	13.0	5.0	7.5	0.6	15.0	N3	900

Reference only

-Vertical crimp taping type  
(Lead Style:N\*)

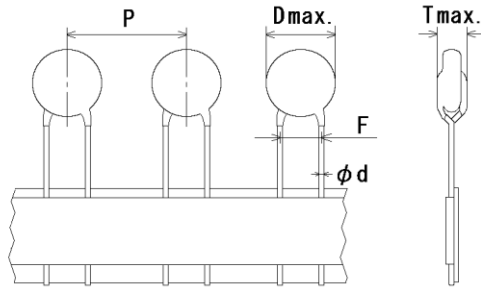

Note) The mark ' \* ' of Lead Style differ from lead spacing (F) ,  
lead diameter (d) and pitch of component (P).  
Please see the following list or taping specification about details.

Unit : mm

Customer Part Number	Murata Part Number	T.C.	Cap. (pF)	Cap. tol.	Dimension (mm)					Lead Style	Pack qty. (pcs)
					D	T	F	d	P		
	DE2E3SA103MN7AY02F	E	10000	±20%	17.0	6.0	7.5	0.6	30.0	N7	400

Reference only

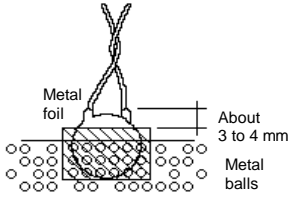
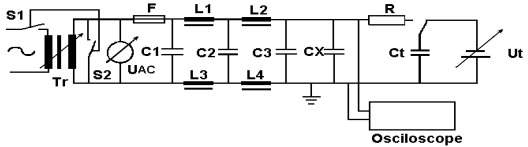
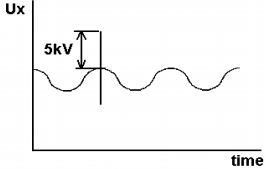
5. Specification and test methods												
No.	Item	Specification	Test method									
1	Appearance and dimensions	No marked defect on appearance form and dimensions. Please refer to [Part number list].	The capacitor should be inspected by naked eyes for visible evidence of defect. Dimensions should be measured with slide calipers.									
2	Marking	To be easily legible.	The capacitor should be inspected by naked eyes.									
3	Dielectric strength	Between lead wires No failure.	The capacitor should not be damaged when AC2,600 V(r.m.s.) <50/60 Hz> is applied between the lead wires for 60 s.									
		Body insulation No failure.	<p>First, the terminals of the capacitor should be connected together.</p> <p>Then, a metal foil should be closely wrapped around the body of the capacitor to the distance of about 3 to 4 mm from each terminal.</p> <p>Then, the capacitor should be inserted into a container filled with metal balls of about 1 mm diameter. Finally, AC2,600 V(r.m.s.) &lt;50/60 Hz&gt; is applied for 60 s between the capacitor lead wires and metal balls.</p> 									
4	Insulation Resistance (I.R.)	10,000 MΩ min.	The insulation resistance should be measured with DC500±50 V within 60±5 s of charging. The voltage should be applied to the capacitor through a resistor of 1 MΩ.									
5	Capacitance	Within specified tolerance.	The capacitance should be measured at 20 °C with 1±0.1 kHz and AC1±0.2 V(r.m.s.) max..									
6	Dissipation Factor (D.F.)	DF ≤ 0.025	The dissipation factor should be measured at 20 °C with 1±0.1 kHz and AC1±0.2 V(r.m.s.) max..									
7	Temperature characteristic	Char. SL : +350 to -1,000 ppm/ °C (Temp. range : 20 to 85 °C) Char. B : Within ±10 % Char. E : Within +20/-55 % (Temp. range : -25 to 85 °C)	The capacitance measurement should be made at each step specified in Table.									
			<table border="1" data-bbox="794 1144 1469 1205"> <thead> <tr> <th>Step</th> <th>1</th> <th>2</th> <th>3</th> <th>4</th> <th>5</th> </tr> </thead> <tbody> <tr> <td>Temp.(°C)</td> <td>20±2</td> <td>-25±2</td> <td>20±2</td> <td>85±2</td> <td>20±2</td> </tr> </tbody> </table>	Step	1	2	3	4	5	Temp.(°C)	20±2	-25±2
Step	1	2	3	4	5							
Temp.(°C)	20±2	-25±2	20±2	85±2	20±2							
8	Active flammability	The cheese-cloth should not be on fire.	<p>The capacitors should be individually wrapped in at least one but more than two complete layers of cheese-cloth. The capacitor should be subjected to 20 discharges. The interval between successive discharges should be 5 s. The UAc should be maintained for 2 min after the last discharge.</p>  <p>           C1,2 : 1 μF±10 %,                      C3 : 0.033 μF±5 % 10 kV            L1 to L4 : 1.5 mH±20 % 16A Rod core choke            R : 100 Ω±2 %,                      Ct : 3μ F±5 % 10 kV            UAc : UR ±5 %                      UR : Rated working voltage            Cx : Capacitor under test            F : Fuse, Rated 10 A            Ut : Voltage applied to Ct         </p> 									

Reference only

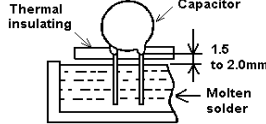
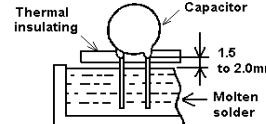
No.	Item	Specification	Test method
9	Robustness of terminations	Tensile	Lead wire should not cut off. Capacitor should not be broken.
		Bending	Fix the body of capacitor, apply a tensile weight gradually to each lead wire in the radial direction of capacitor up to 10 N and keep it for 10±1 s.  With the termination in its normal position, the capacitor is held by its body in such a manner that the axis of the termination is vertical; a mass applying a force of 5 N is then suspended from the end of the termination.  The body of the capacitor is then inclined, within a period of 2 to 3 s, through an angle of about 90 ° in the vertical plane and then returned to its initial position over the same period of time; this operation constitutes one bend.  One bend immediately followed by a second bend in the opposite direction.
10	Vibration resistance	Appearance	No marked defect.
		Capacitance	Within the specified tolerance.
		Dissipation Factor (D.F.)	DF ≤ 0.025
			The capacitor should be firmly soldered to the supporting lead wire and vibration which is 10 to 55 Hz in the vibration frequency range, 1.5 mm in total amplitude, and about 1 min in the rate of vibration change from 10 Hz to 55 Hz and back to 10 Hz is applied for a total of 6 h; 2 h each in 3 mutually perpendicular directions.
11	Solderability of leads	Lead wire should be soldered with uniformly coated on the axial direction over 3/4 of the circumferential direction.	The lead wire of a capacitor should be dipped into a ethanol solution of 25 wt% rosin and then into molten solder for 2±0.5 s. In both cases the depth of dipping is up to about 1.5 to 2.0 mm from the root of lead wires. Temp. of solder : 245±5 °C Lead Free Solder (Sn-3Ag-0.5Cu)
12	Soldering effect (Non-preheat)	Appearance	No marked defect.
		Capacitance change	Within ±10 %
		I.R.	1,000 MΩ min.
		Dielectric strength	Per item 3
			Solder temperature : 350±10 °C or 260±5 °C Immersion time : 3.5±0.5 s (In case of 260±5 °C : 10±1 s) The depth of immersion is up to about 1.5 to 2.0 mm from the root of lead wires.   Pre-treatment : Capacitor should be stored at 125±2 °C for 1 h, and apply the AC2,000 V(r.m.s.) 60 s then placed at *room condition for 24±2 h before initial measurements. (Do not apply to Char. SL) Post-treatment : Capacitor should be stored for 1 to 2 h at *room condition.
13	Soldering effect (On-preheat)	Appearance	No marked defect.
		Capacitance change	Within ±10 %
		I.R.	1,000 MΩ min.
		Dielectric strength	Per item 3
			First the capacitor should be stored at 120+0/-5 °C for 60+0/-5 s. Then, as in figure, the lead wires should be immersed solder of 260+0/-5 °C up to 1.5 to 2.0 mm from the root of terminal for 7.5+0/-1 s.   Pre-treatment : Capacitor should be stored at 125±2 °C for 1 h, and apply the AC2,000 V(r.m.s.) 60 s then placed at *room condition for 24±2 h before initial measurements. (Do not apply to Char. SL) Post-treatment : Capacitor should be stored for 1 to 2 h at *room condition.

\*"room condition" Temperature : 15 to 35 °C, Relative humidity : 45 to 75 %, Atmospheric pressure : 86 to 106 kPa

Reference only

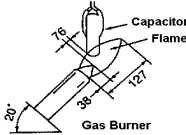
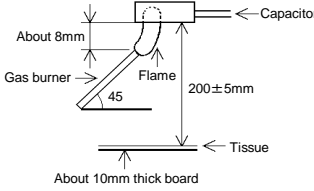
No.	Item	Specification	Test method						
14	Flame test	The capacitor flame discontinue as follows. <table border="1" style="margin-left: 20px;"> <thead> <tr> <th>Cycle</th> <th>Time</th> </tr> </thead> <tbody> <tr> <td>1 to 4</td> <td>30 s max.</td> </tr> <tr> <td>5</td> <td>60 s max.</td> </tr> </tbody> </table>	Cycle	Time	1 to 4	30 s max.	5	60 s max.	The capacitor should be subjected to applied flame for 15 s. and then removed for 15 s until 5 cycles. <div style="text-align: center;">  <p>(in mm)</p> </div>
Cycle	Time								
1 to 4	30 s max.								
5	60 s max.								
15	Passive flammability	The burning time should not be exceeded the time 30 s. The tissue paper should not ignite.	The capacitor under test should be held in the flame in the position which best promotes burning. Time of exposure to flame is for 30 s. <p style="margin-left: 20px;">                         Length of flame : 12±1 mm                          Gas burner : Length 35 mm min.                          Inside Dia. 0.5±0.1 mm                          Outside Dia. 0.9 mm max.                          Gas : Butane gas Purity 95 % min.                     </p> <div style="text-align: center;">  </div>						
16	Humidity (Under steady state)	Appearance	No marked defect.	Set the capacitor for 500±12 h at 40±2 °C in 90 to 95 % relative humidity.  Pre-treatment : Capacitor should be stored at 125±2 °C for 1 h, and apply the AC2,000 V(r.m.s.) 60 s then placed at *room condition for 24±2 h before initial measurements. (Do not apply to Char. SL)  Post-treatment : Capacitor should be stored for 1 to 2 h at *room condition.					
		Capacitance change	Char. SL : Within ±5 % Char. B : Within ±10 % Char. E : Within ±15 %						
		Dissipation Factor (D.F.)	Char. SL : DF ≤ 0.025 Char. B, E : DF ≤ 0.05						
		I.R.	3,000 MΩ min.						
		Dielectric strength	Per item 3						
17	Humidity loading	Appearance	No marked defect.	Apply AC440 V(r.m.s.) for 500±12 h at 40±2 °C in 90 to 95 % relative humidity.  Pre-treatment : Capacitor should be stored at 125±2 °C for 1 h, and apply the AC2,000 V(r.m.s.) 60 s then placed at *room condition for 24±2 h before initial measurements. (Do not apply to Char. SL)  Post-treatment : Capacitor should be stored for 1 to 2 h at *room condition.					
		Capacitance change	Char. SL : Within ±5 % Char. B : Within ±10 % Char. E : Within ±15 %						
		Dissipation Factor (D.F.)	Char. SL : DF ≤ 0.025 Char. B, E : DF ≤ 0.05						
		I.R.	3,000 MΩ min.						
		Dielectric strength	Per item 3						
* "room condition" Temperature : 15 to 35 °C, Relative humidity : 45 to 75 %, Atmospheric pressure : 86 to 106 kPa									

Reference only

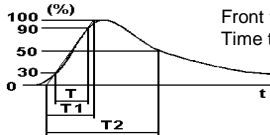
No.	Item	Specification	Test method																										
18	Life	Appearance	No marked defect.																										
		Capacitance change	Within $\pm 20\%$																										
		I.R.	3,000 M $\Omega$ min.																										
		Dielectric strength	Per item 3																										
				<p>Impulse voltage</p> <p>Each individual capacitor should be subjected to a 8 kV impulses for three times or more. Then the capacitors are applied to life test.</p>  <p>Front time (T1) = <math>1.7 \mu s = 1.67T</math> Time to half-value (T2) = 50 <math>\mu s</math></p> <p>The capacitors are placed in a circulating air oven for a period of 1,000 h. The air in the oven is maintained at a temperature of <math>125 \pm 2 / -0</math> °C, and relative humidity of 50 % max.. Throughout the test, the capacitors are subjected to a AC680 V(r.m.s.) &lt;50/60 Hz&gt; alternating voltage of mains frequency, except that once each hour the voltage is increased to AC1,000 V(r.m.s.) for 0.1 s.</p> <p>Pre-treatment : Capacitor should be stored at <math>125 \pm 2</math> °C for 1 h, and apply the AC2,000 V(r.m.s.) 60 s then placed at *room condition for <math>24 \pm 2</math> h before initial measurements. (Do not apply to Char. SL)</p> <p>Post-treatment : Capacitor should be stored for <math>24 \pm 2</math> h at *room condition.</p>																									
19	Temperature and immersion cycle	Appearance	No marked defect.																										
		Capacitance change	Char. SL : Within $\pm 5\%$ Char. B : Within $\pm 10\%$ Char. E : Within $\pm 20\%$																										
		Dissipation Factor (D.F.)	Char. SL : $DF \leq 0.025$ Char. B, E : $DF \leq 0.05$																										
		I.R.	3,000 M $\Omega$ min.																										
		Dielectric strength	Per item 3																										
		<p>The capacitor should be subjected to 500 temperature cycles, then consecutively to 2 immersion cycles.</p> <p>&lt;Temperature cycle&gt;</p> <table border="1" data-bbox="890 958 1305 1115"> <thead> <tr> <th>Step</th> <th>Temperature(°C)</th> <th>Time</th> </tr> </thead> <tbody> <tr> <td>1</td> <td>-40+0/-3</td> <td>30 min</td> </tr> <tr> <td>2</td> <td>Room temp.</td> <td>3 min</td> </tr> <tr> <td>3</td> <td>125+3/-0</td> <td>30 min</td> </tr> <tr> <td>4</td> <td>Room temp.</td> <td>3 min</td> </tr> </tbody> </table> <p>Cycle time : 500 cycles</p> <p>&lt;Immersion cycle&gt;</p> <table border="1" data-bbox="890 1182 1471 1281"> <thead> <tr> <th>Step</th> <th>Temperature(°C)</th> <th>Time</th> <th>Immersion water</th> </tr> </thead> <tbody> <tr> <td>1</td> <td>65+5/-0</td> <td>15 min</td> <td>Clean water</td> </tr> <tr> <td>2</td> <td>0<math>\pm</math>3</td> <td>15 min</td> <td>Salt water</td> </tr> </tbody> </table> <p>Cycle time : 2 cycles</p> <p>Pre-treatment : Capacitor should be stored at <math>125 \pm 2</math> °C for 1 h, and apply the AC2,000 V(r.m.s.) 60 s then placed at *room condition for <math>24 \pm 2</math> h before initial measurements. (Do not apply to Char. SL)</p> <p>Post-treatment : Capacitor should be stored for <math>24 \pm 2</math> h at *room condition.</p>	Step	Temperature(°C)	Time	1	-40+0/-3	30 min	2	Room temp.	3 min	3	125+3/-0	30 min	4	Room temp.	3 min	Step	Temperature(°C)	Time	Immersion water	1	65+5/-0	15 min	Clean water	2	0 $\pm$ 3	15 min	Salt water
Step	Temperature(°C)	Time																											
1	-40+0/-3	30 min																											
2	Room temp.	3 min																											
3	125+3/-0	30 min																											
4	Room temp.	3 min																											
Step	Temperature(°C)	Time	Immersion water																										
1	65+5/-0	15 min	Clean water																										
2	0 $\pm$ 3	15 min	Salt water																										

\* "room condition" Temperature : 15 to 35 °C, Relative humidity : 45 to 75 %, Atmospheric pressure : 86 to 106 kPa

6. Packing specification

- Bulk type (Package : B)

The size of packing case and packing way

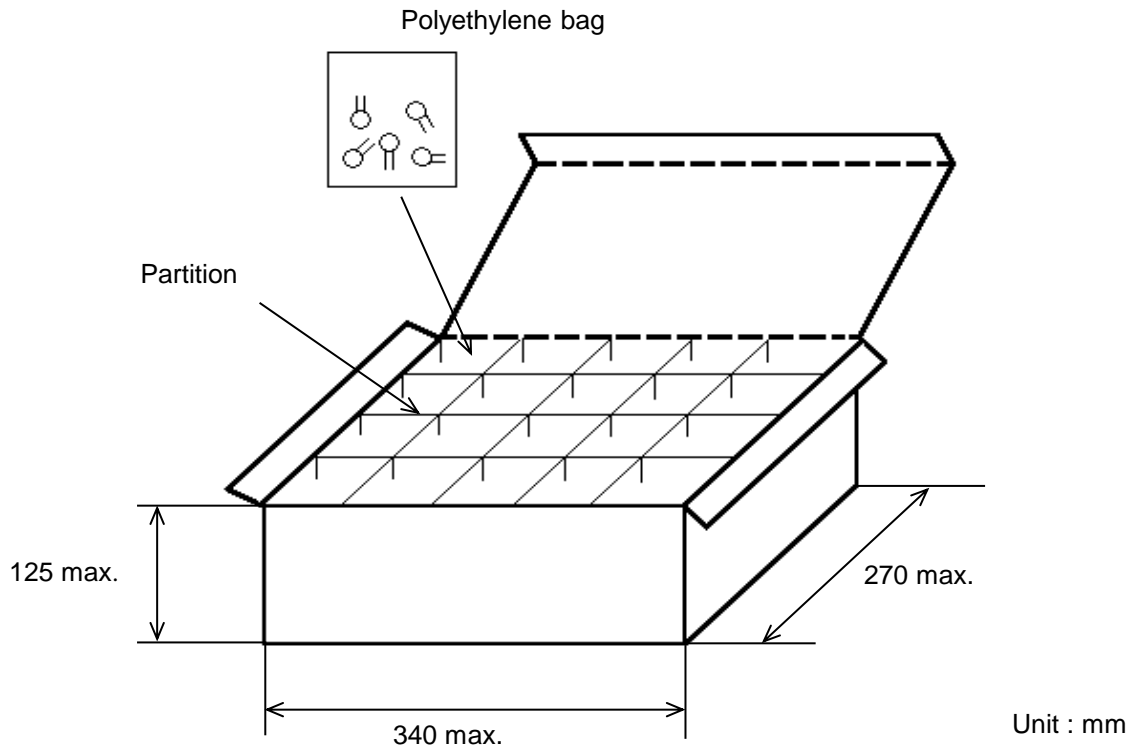

$$\text{The number of packing} = {}^{*1} \text{ Packing quantity} \times {}^{*2} n$$

\*1 : Please refer to [Part number list].

\*2 : Standard n = 20 (bag)

Note)

The outer package and the number of outer packing be changed by the order getting amount.



• Ammo pack taping type (Package : A)

- The tape with capacitors is packed zigzag into a case.
- When body of the capacitor is piled on other body under it.
- There should be 3 pitches and over without capacitors in leader and trailer.

The size of packing case and packing way

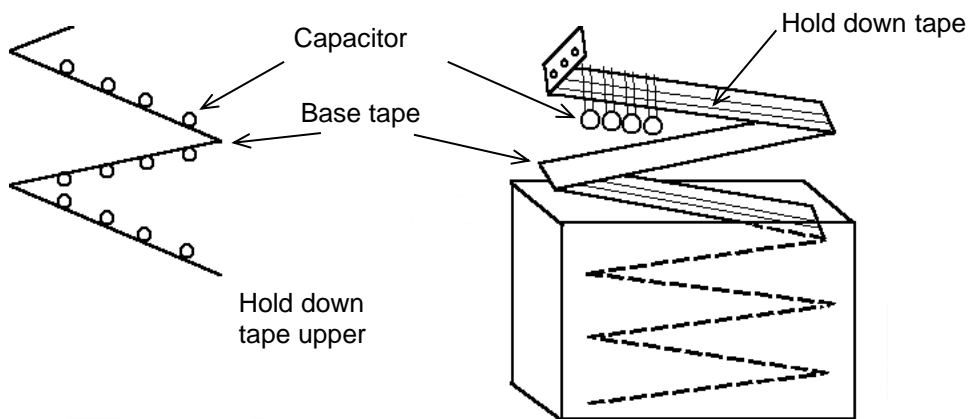
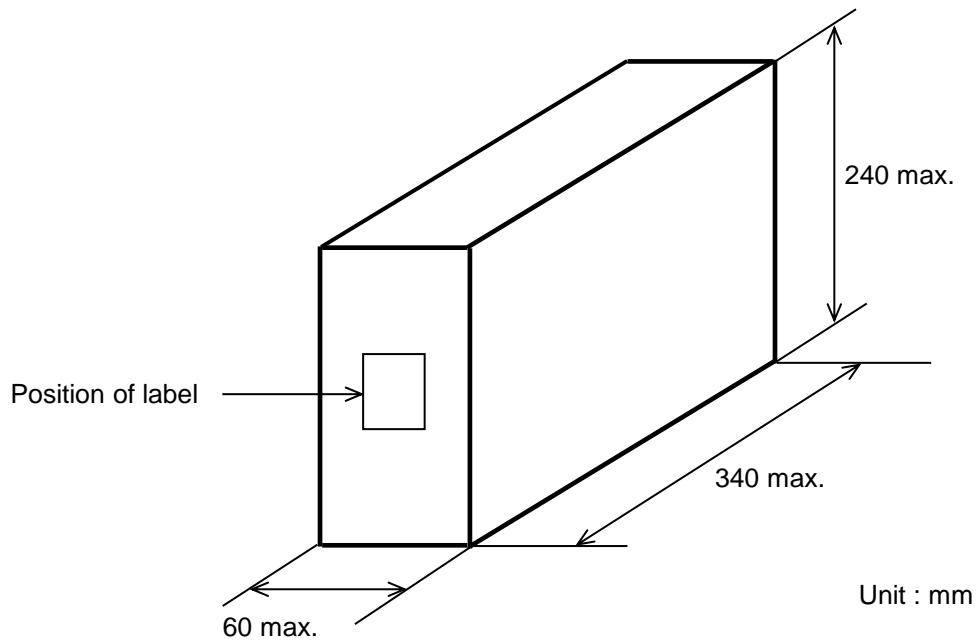

7. Taping specification

7-1. Dimension of capacitors on tape

Vertical crimp taping type < Lead Style : N3 >

Pitch of component 15.0 mm / Lead spacing 7.5 mm

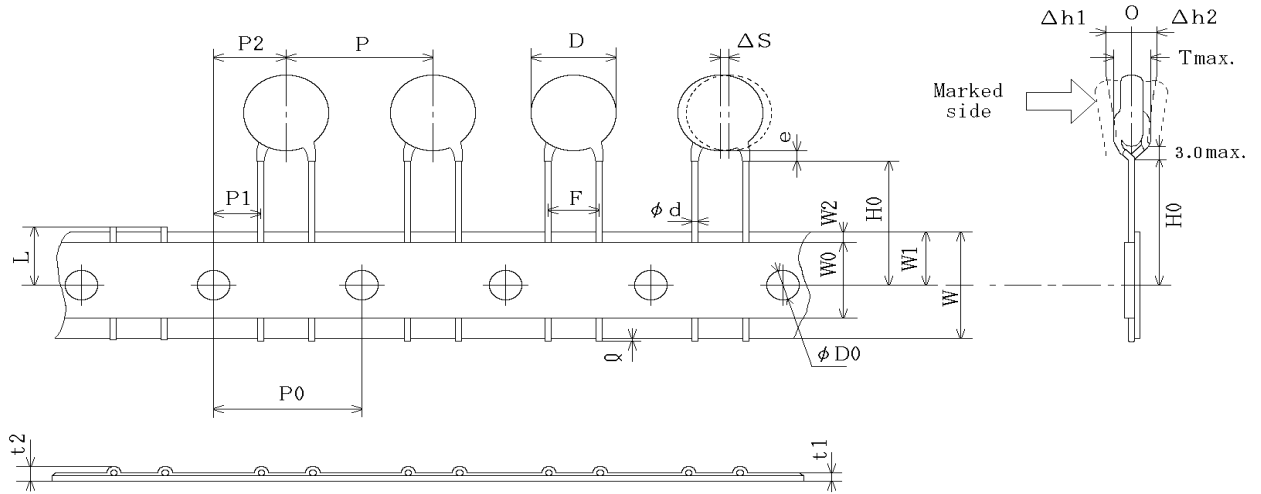

Unit : mm

Item	Code	Dimensions	Remarks
Pitch of component	P	15.0+/-2.0	
Pitch of sprocket hole	P0	15.0+/-0.3	
Lead spacing	F	7.5+/-1.0	
Length from hole center to component center	P2	7.5+/-1.5	Deviation of progress direction
Length from hole center to lead	P1	3.75+/-1.0	
Body diameter	D	Please refer to [Part number list ].	
Deviation along tape, left or right	ΔS	0+/-2.0	They include deviation by lead bend.
Carrier tape width	W	18.0+/-0.5	
Position of sprocket hole	W1	9.0+/-0.5	Deviation of tape width direction
Lead distance between reference and bottom planes	H0	18.0+2.0/-0	
Protrusion length	ℓ	+0.5~-1.0	
Diameter of sprocket hole	ΦD0	4.0+/-0.1	
Lead diameter	Φd	0.60+/-0.05	
Total tape thickness	t1	0.6+/-0.3	They include hold down tape thickness.
Total thickness of tape and lead wire	t2	1.5 max.	
Deviation across tape, front	Δh1	2.0 max.	
Deviation across tape, rear	Δh2		
Portion to cut in case of defect	L	11.0+0/-1.0	
Hold down tape width	W0	11.5 min.	
Hold down tape position	W2	1.5+/-1.5	
Coating extension on lead	e	Up to the end of crimp	
Body thickness	T	Please refer to [Part number list ].	

Reference only

Vertical crimp taping type < Lead Style : N7 >

Pitch of component 30.0 mm / Lead spacing 7.5 mm

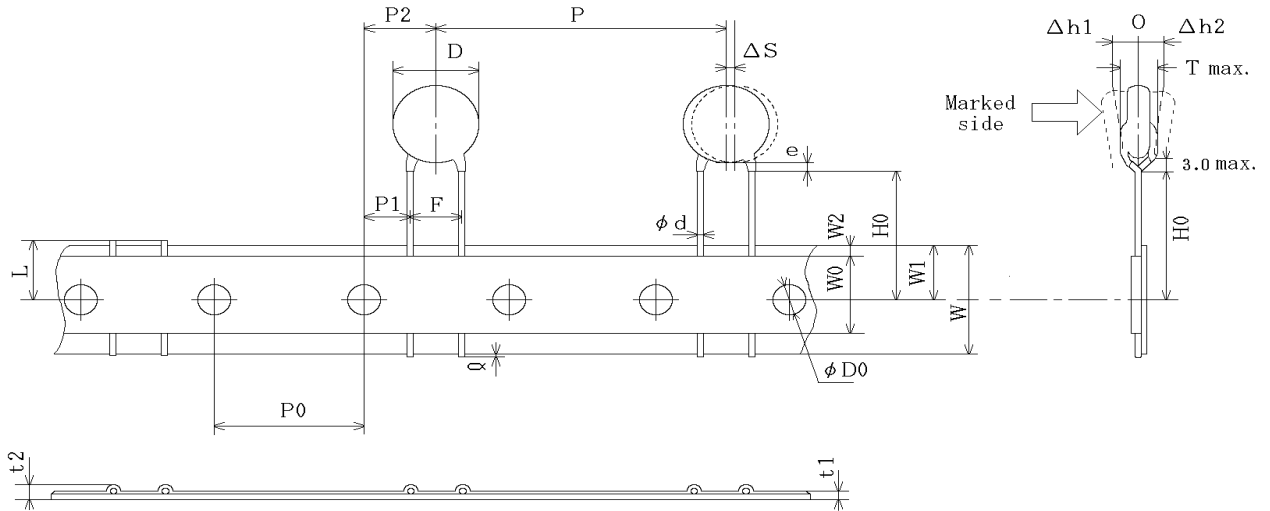

Unit : mm

Item	Code	Dimensions	Remarks
Pitch of component	P	30.0+/-2.0	
Pitch of sprocket hole	P0	15.0+/-0.3	
Lead spacing	F	7.5+/-1.0	
Length from hole center to component center	P2	7.5+/-1.5	Deviation of progress direction
Length from hole center to lead	P1	3.75+/-1.0	
Body diameter	D	Please refer to [Part number list ].	
Deviation along tape, left or right	ΔS	0+/-2.0	They include deviation by lead bend.
Carrier tape width	W	18.0+/-0.5	
Position of sprocket hole	W1	9.0+/-0.5	Deviation of tape width direction
Lead distance between reference and bottom planes	H0	18.0+2.0/-0	
Protrusion length	ℓ	+0.5~-1.0	
Diameter of sprocket hole	ΦD0	4.0+/-0.1	
Lead diameter	Φd	0.60+/-0.05	
Total tape thickness	t1	0.6+/-0.3	They include hold down tape thickness.
Total thickness of tape and lead wire	t2	1.5 max.	
Deviation across tape, front	Δh1	2.0 max.	
Deviation across tape, rear	Δh2		
Portion to cut in case of defect	L	11.0+0/-1.0	
Hold down tape width	W0	11.5 min.	
Hold down tape position	W2	1.5+/-1.5	
Coating extension on lead	e	Up to the end of crimp	
Body thickness	T	Please refer to [Part number list ].	

7-2. Splicing way of tape

1) Adhesive force of tape is over 3 N at test condition as below.

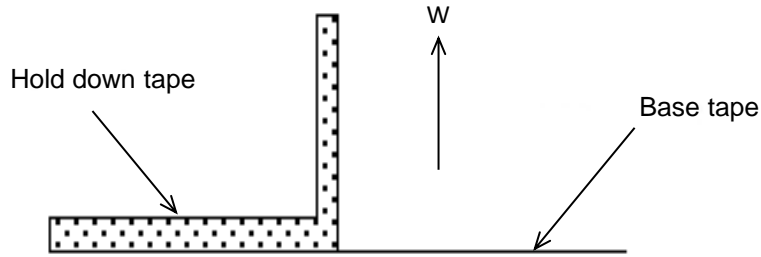

2) Splicing of tape

a) When base tape is spliced

- Base tape should be spliced by cellophane tape.  
(Total tape thickness should be less than 1.05 mm.)

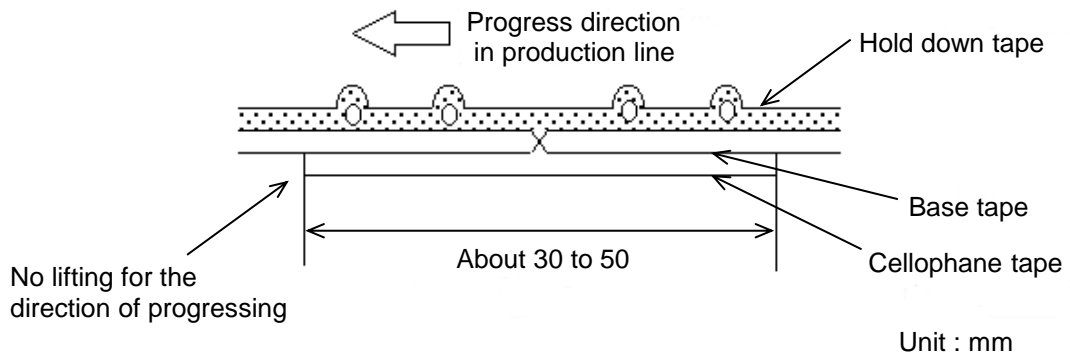

b) When hold down tape is spliced

- Hold down tape should be spliced with overlapping.  
(Total tape thickness should be less than 1.05 mm.)

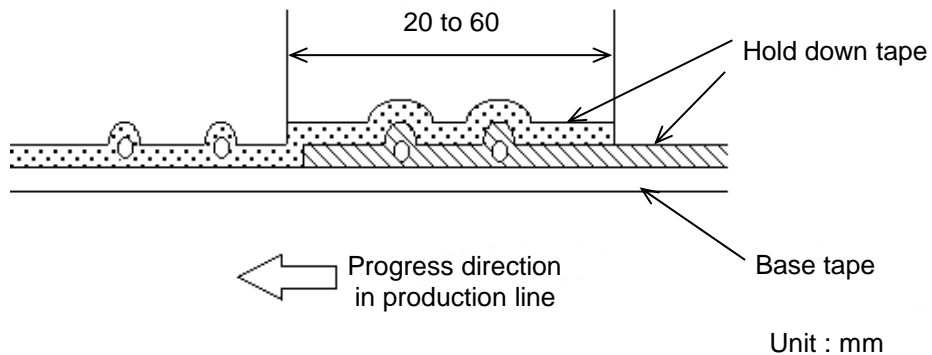

c) When both tape are spliced

- Base tape and hold down tape should be spliced with splicing tape.

3) Missing components

- There should be no consecutive missing of more than three components.
- The number of missing components should be not more than 0.5 % of total components that should be present in a Ammo pack.