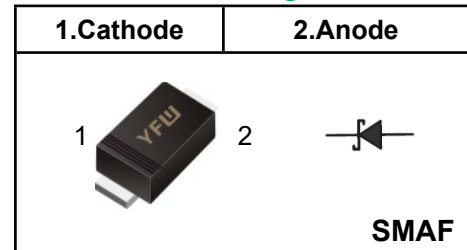

Surface Mount Schottky Barrier Rectifier
Reverse Voltage - 100 V
Forward Current - 5 A
FEATURES

- ◆Metal silicon junction, majority carrier conduction
- ◆For surface mounted applications
- ◆Low power loss, high efficiency
- ◆High forward surge current capability
- ◆For use in low voltage, high frequency inverters, free wheeling, and polarity protection applications
- ◆Lead free in comply with EU RoHS 2011/65/EU directives

MECHANICAL DATA

- ◆Case: SMAF
- ◆Terminals: Solderable per MIL-STD-750, Method 2026
- ◆Approx. Weight: 27mg / 0.00095oz

Pinning

Marking Code

SSL510F	SL510
----------------	--------------

Absolute Maximum Ratings and Electrical characteristics

Ratings at 25 ° ambient temperature unless otherwise specified.Single phase, half wave, 60Hz resistive or inductive load, for capacitive load, derate by 20 %

Parameter	Symbols	SSL510F	Units
Maximum Repetitive Peak Reverse Voltage	V_{RRM}	100	V
Maximum RMS voltage	V_{RMS}	70	V
Maximum DC Blocking Voltage	V_{DC}	100	V
Maximum Average Forward Rectified Current	$I_{F(AV)}$	5.0	A
Peak Forward Surge Current, 8.3ms Single Half Sine-wave Superimposed On Rated Load (JEDEC method)	I_{FSM}	150	A
Maximum Instantaneous Forward Voltage at 5 A	V_F	0.6	V
Maximum Instantaneous Reverse Current at Rated DC Reverse Voltage	I_R	1.0 50	mA
Typical Junction Capacitance ⁽¹⁾	C_j	400	pF
Typical Thermal Resistance ⁽²⁾	$R_{\theta JA}$	60	°C/W
Operating Junction Temperature Range	T_j	-55 ~ +150	°C
Storage Temperature Range	T_{stg}	-55 ~ +150	°C

(1) Measured at 1 MHz and applied reverse voltage of 4 V D.C

(2) P.C.B. mounted with 2.0" X 2.0" (5 X 5 cm) copper pad areas.

Fig.1 Forward Current Derating Curve

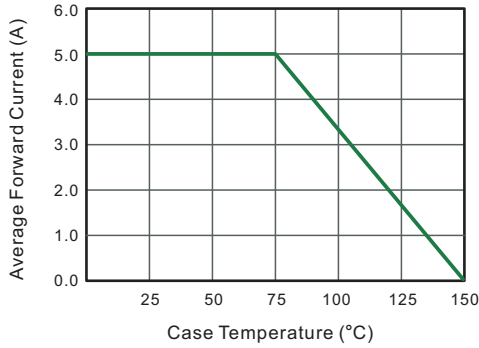

Fig.2 Typical Reverse Characteristics

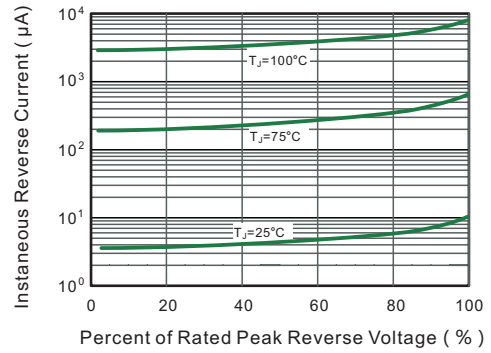

Fig.3 Typical Forward Characteristic

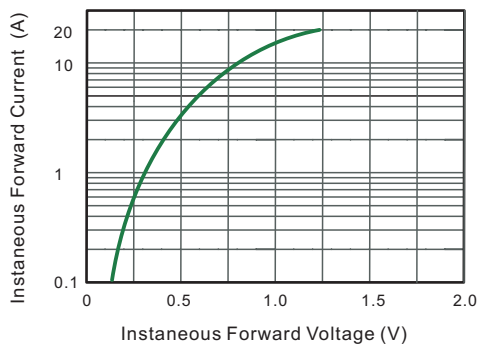

Fig.4 Typical Junction Capacitance

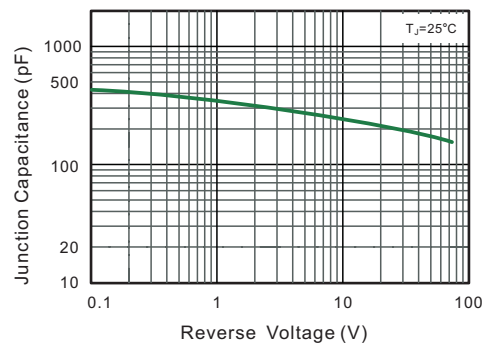

Fig.5 Maximum Non-Repetitive Peak Forward Surge Current

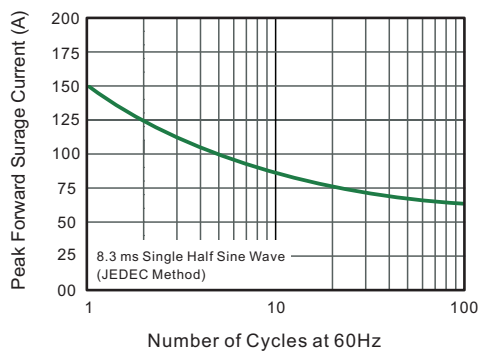
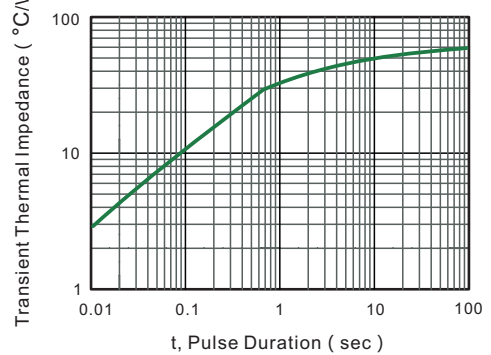
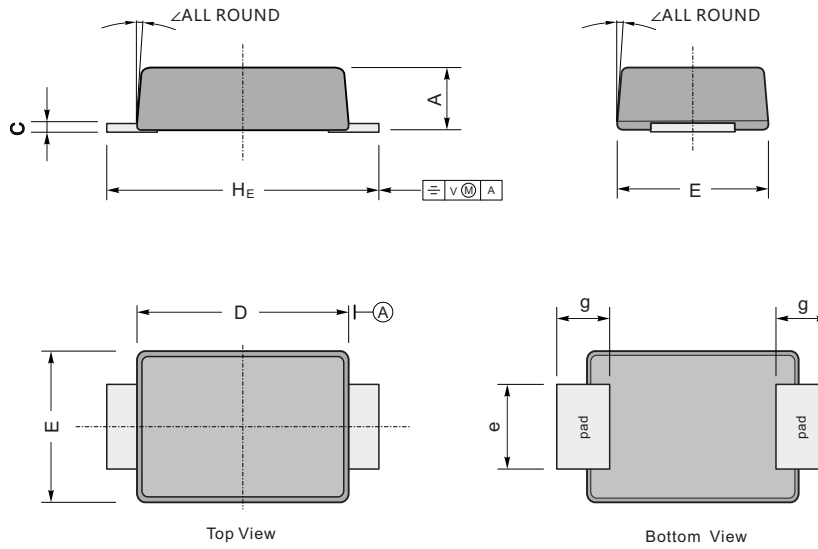

Fig.6- Typical Transient Thermal Impedance



Package Outline SMAF

Plastic surface mounted package; 2 leads



UNIT		A	C	D	E	e	g	H _E	\angle
mm	max	1.1	0.20	3.7	2.7	1.6	1.2	4.9	7°
	min	0.9	0.12	3.3	2.4	1.3	0.8	4.4	
mil	max	43	7.9	146	106	63	47	193	
	min	35	4.7	130	94	51	31	173	

The recommended mounting pad size

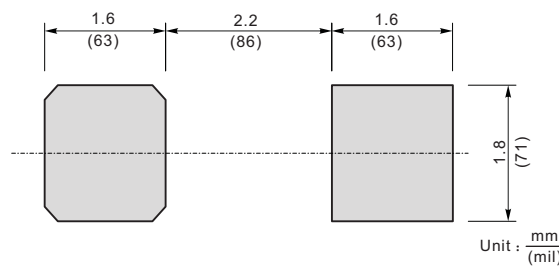

Summary of Packing Options

Package	Packing Description	Packing Quantity	Industry Standard
SMAF	Tape/Reel, 13" reel	10000	EIA-481-1
	Tape/Reel, 7" reel	3000	EIA-481-1