

Aluminum Capacitors +105 °C, Tubular, Axial Lead

FEATURES

- Temperature range -55 °C to +105 °C
- Long life
- Material categorization: for definitions of compliance please see www.vishay.com/doc?99912



QUICK REFERENCE DATA	
DESCRIPTION	VALUE
Nominal case size Ø D x L in mm	0.625" x 1.125" [15.875 x 28.575] to 1.0" x 3.625" [25.4 x 92.075]
Operating temperature	-55 °C to +105 °C
Rated capacitance range, C _R	12 µF to 33 000 µF
Tolerance on C _R	-10 %, +50 %
Rated voltage range, U _R	6.3 WV _{DC} to 300 WV _{DC}
Termination	Axial leads
Life validation test 2000 h at 105 °C	Δ CAP ≤ 15 % from initial measurement. Δ ESR ≤ 1.25 x initial specified limit. Δ DCL ≤ initial specified limit.
Shelf life 500 h at 105 °C	Δ CAP ≤ 10 % from initial measurement. Δ ESR ≤ 1.15 x initial specified limit. Δ DCL ≤ 2.0 x initial specified limit.
DC leakage current (after 5 min charge)	$I = k \sqrt{CV}$ k = 0.5 at +25 °C k = 3.0 at +105 °C I in µA, C in µF, V in Volts

RIPPLE CURRENT MULTIPLIERS			
TEMPERATURE			
AMBIENT TEMPERATURE		MULTIPLIERS	
+105 °C		0.4	
+65 °C		1.7	
+45 °C		2.0	
+25 °C		2.6	
FREQUENCY (Hz)			
WV _{DC}	50 TO 60	300 TO 400	1000 AND UP
0 to 60	0.85	1.10	1.15
61 to 250	0.83	1.15	1.20

LOW TEMPERATURE PERFORMANCE	
CAPACITANCE RATIO C ^{-55 °C} / C ^{+25 °C} MINIMUM AT 120 Hz	
RATED VOLTAGE WV _{DC}	CAPACITANCE REMAINING
0 to 25	75 %
26 to 100	80 %
101 to 250	85 %
ESR RATIO ESR ^{-55 °C} / ESR ^{+25 °C} MAXIMUM AT 120 Hz	
RATED VOLTAGE WV _{DC}	MULTIPLIER
0 to 9	10
10 to 40	12
41 to 250	18

DIMENSIONS in inches [millimeters]					
CASE CODE	STYLE 1 AND 2 INSULATING SLEEVE		STYLE 3 AND 7 INSULATING SLEEVE, COATED END SEAL		TYPICAL WEIGHT
	D	L	D	L	
FE	0.635 ± 0.020 [16.1 ± 0.51]	1.141 ± 0.062 [29.0 ± 1.57]	0.635 ± 0.020 [16.1 ± 0.51]	1.187 ± 0.062 [30.2 ± 1.57]	0.32 oz. (9.0 g)
FJ	0.635 ± 0.020 [16.1 ± 0.51]	1.641 ± 0.062 [41.7 ± 1.57]	0.635 ± 0.020 [16.1 ± 0.51]	1.687 ± 0.062 [42.9 ± 1.57]	0.39 oz. (11.0 g)
FL	0.635 ± 0.020 [16.1 ± 0.51]	2.141 ± 0.062 [54.4 ± 1.57]	0.635 ± 0.020 [16.1 ± 0.51]	2.187 ± 0.062 [55.6 ± 1.57]	0.53 oz. (15.0 g)
FP	0.635 ± 0.020 [16.1 ± 0.51]	2.641 ± 0.062 [67.1 ± 1.57]	0.635 ± 0.020 [16.1 ± 0.51]	2.687 ± 0.062 [68.3 ± 1.57]	0.63 oz. (18.0 g)
FS	0.635 ± 0.020 [16.1 ± 0.51]	3.141 ± 0.062 [79.8 ± 1.57]	0.635 ± 0.020 [16.1 ± 0.51]	3.187 ± 0.062 [81.0 ± 1.57]	0.88 oz. (25.0 g)
FT	0.635 ± 0.020 [16.1 ± 0.51]	3.641 ± 0.062 [92.5 ± 1.57]	0.635 ± 0.020 [16.1 ± 0.51]	3.687 ± 0.062 [93.7 ± 1.57]	0.98 oz. (28.0 g)
GE	0.760 ± 0.020 [19.3 ± 0.51]	1.141 ± 0.062 [29.0 ± 1.57]	0.760 ± 0.020 [19.3 ± 0.51]	1.187 ± 0.062 [30.2 ± 1.57]	0.46 oz. (13.0 g)
GJ	0.760 ± 0.020 [19.3 ± 0.51]	1.641 ± 0.062 [41.7 ± 1.57]	0.760 ± 0.020 [19.3 ± 0.51]	1.687 ± 0.062 [42.9 ± 1.57]	0.67 oz. (19.0 g)

DIMENSIONS in inches [millimeters]					
CASE CODE	STYLE 1 AND 2 INSULATING SLEEVE		STYLE 3 AND 7 INSULATING SLEEVE, COATED END SEAL		TYPICAL WEIGHT
	D	L	D	L	
GL	0.760 ± 0.020 [19.3 ± 0.51]	2.141 ± 0.062 [54.4 ± 1.57]	0.760 ± 0.020 [19.3 ± 0.51]	2.187 ± 0.062 [55.6 ± 1.57]	0.74 oz. (21.0 g)
GP	0.760 ± 0.020 [19.3 ± 0.51]	2.641 ± 0.062 [67.1 ± 1.57]	0.760 ± 0.020 [19.3 ± 0.51]	2.687 ± 0.062 [68.3 ± 1.57]	0.88 oz. (25.0 g)
GS	0.760 ± 0.020 [19.3 ± 0.51]	3.141 ± 0.062 [79.8 ± 1.57]	0.760 ± 0.020 [19.3 ± 0.51]	3.187 ± 0.062 [81.0 ± 1.57]	1.16 oz. (33.0 g)
GT	0.760 ± 0.020 [19.3 ± 0.51]	3.641 ± 0.062 [92.5 ± 1.57]	0.760 ± 0.020 [19.3 ± 0.51]	3.687 ± 0.062 [93.7 ± 1.57]	1.33 oz. (38.0 g)
HE	0.885 ± 0.020 [22.5 ± 0.51]	1.141 ± 0.062 [29.0 ± 1.57]	0.885 ± 0.020 [22.5 ± 0.51]	1.187 ± 0.062 [30.2 ± 1.57]	0.63 oz. (18.0 g)
HJ	0.885 ± 0.020 [22.5 ± 0.51]	1.641 ± 0.062 [41.7 ± 1.57]	0.885 ± 0.020 [22.5 ± 0.51]	1.687 ± 0.062 [42.9 ± 1.57]	0.95 oz. (27.0 g)
HL	0.885 ± 0.020 [22.5 ± 0.51]	2.141 ± 0.062 [54.4 ± 1.57]	0.885 ± 0.020 [22.5 ± 0.51]	2.187 ± 0.062 [55.6 ± 1.57]	1.02 oz. (29.0 g)
HP	0.885 ± 0.020 [22.5 ± 0.51]	2.641 ± 0.062 [67.1 ± 1.57]	0.885 ± 0.020 [22.5 ± 0.51]	2.687 ± 0.062 [68.3 ± 1.57]	1.37 oz. (39.0 g)
HS	0.885 ± 0.020 [22.5 ± 0.51]	3.141 ± 0.062 [79.8 ± 1.57]	0.885 ± 0.020 [22.5 ± 0.51]	3.187 ± 0.062 [81.0 ± 1.57]	1.72 oz. (49.0 g)
HT	0.885 ± 0.020 [22.5 ± 0.51]	3.641 ± 0.062 [92.5 ± 1.57]	0.885 ± 0.020 [22.5 ± 0.51]	3.687 ± 0.062 [93.7 ± 1.57]	2.07 oz. (59.0 g)
JE	1.010 ± 0.020 [25.7 ± 0.51]	1.141 ± 0.062 [29.0 ± 1.57]	1.010 ± 0.020 [25.7 ± 0.51]	1.187 ± 0.062 [30.2 ± 1.57]	0.81 oz. (23.0 g)
JJ	1.010 ± 0.020 [25.7 ± 0.51]	1.641 ± 0.062 [41.7 ± 1.57]	1.010 ± 0.020 [25.7 ± 0.51]	1.687 ± 0.062 [42.9 ± 1.57]	1.02 oz. (29.0 g)
JL	1.010 ± 0.020 [25.7 ± 0.51]	2.141 ± 0.062 [54.4 ± 1.57]	1.010 ± 0.020 [25.7 ± 0.51]	2.187 ± 0.062 [55.5 ± 1.57]	1.54 oz. (44.0 g)
JP	1.010 ± 0.020 [25.7 ± 0.51]	2.641 ± 0.062 [67.1 ± 1.57]	1.010 ± 0.020 [25.7 ± 0.51]	2.687 ± 0.062 [68.3 ± 1.57]	1.86 oz. (53.0 g)
JS	1.010 ± 0.020 [25.7 ± 0.51]	3.141 ± 0.062 [79.8 ± 1.57]	1.010 ± 0.020 [25.7 ± 0.51]	3.187 ± 0.062 [81.0 ± 1.57]	2.21 oz. (63.0 g)
JT	1.010 ± 0.020 [25.7 ± 0.51]	3.641 ± 0.062 [92.5 ± 1.57]	1.010 ± 0.020 [25.7 ± 0.51]	3.687 ± 0.062 [93.7 ± 1.57]	2.52 oz. (72.0 g)

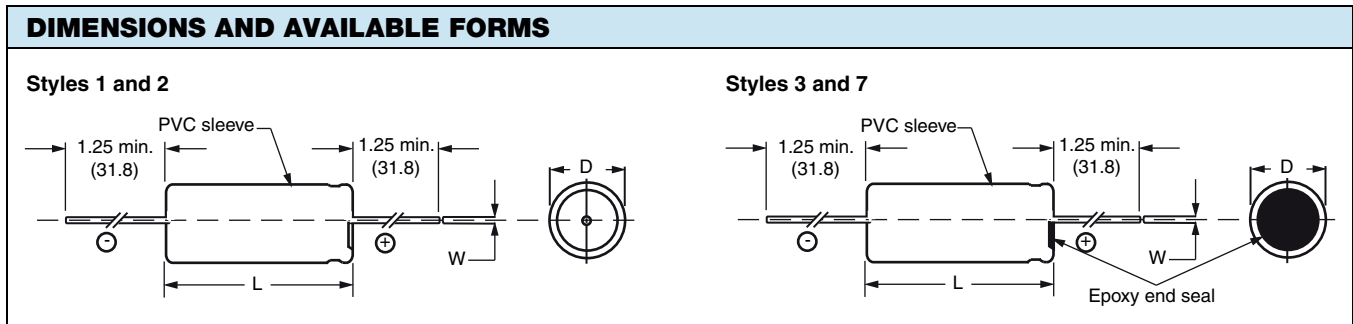

PART NUMBER INFORMATION					
601D TYPE	158 CAPACITANCE	F CAPACITANCE TOLERANCE	6R3 DC VOLTAGE RATING	FE CASE CODE	1 CASE STYLE
Identifies the series name.	Expressed in pF. The first two digits are significant figures. The third is the number of zeros.	F = -10 % / +50 % (std.)	Expressed in volts. The letter "R" signifies a decimal point (i.e. 6R3 = 6.3 V).	See table Dimensions	1 = PVC sleeve (std.) 2 = polyester sleeve 3 = polyester sleeve with epoxy end seal (required for exposure to halogenated cleaning solvents) 7 = PVC sleeve with epoxy end seal (required for exposure to halogenated cleaning solvents)

**ORDERING EXAMPLE (1)**

Electrolytic capacitor 601D series: 601D158F050GL1

Note

(1) For lead (Pb)-free / RoHS compliant products add suffix "E3" to part number. Example: 601D158F050GL1E3

ELECTRICAL DATA AND ORDERING INFORMATION					
CAPACITANCE (μF)	PART NUMBER	NOMINAL CASE SIZE D x L (in)	LEAD DIAMETER W (in)	MAX. ESR AT 120 Hz / 25 °C (Ω)	MAX. RIPPLE CURRENT AT 120 Hz / 85 °C (A)
6.3 WV_{DC} AT +85 °C, SURGE = 8 V					
1500	601D158F6R3FE1	0.625 x 1.125	No. 20 AWG (0.032)	0.311	1.04
2700	601D278F6R3FJ1	0.625 x 1.625		0.148	1.76
3900	601D398F6R3FL1	0.625 x 2.125		0.098	2.41
5600	601D568F6R3FP1	0.625 x 2.625		0.074	3.05
6800	601D688F6R3FS1	0.625 x 3.125		0.060	3.66
8200	601D828F6R3FT1	0.625 x 3.625		0.051	4.26
2700	601D278F6R3GE1	0.750 x 1.125	No. 18 AWG (0.040)	0.169	1.58
5600	601D568F6R3GJ1	0.750 x 1.625		0.083	2.60
8200	601D828F6R3GL1	0.750 x 2.125		0.057	3.52
10 000	601D109F6R3GP1	0.750 x 2.625		0.043	4.40
12 000	601D129F6R3GS1	0.750 x 3.125		0.037	5.13
15 000	601D159F6R3GT1	0.750 x 3.625		0.031	5.98
3900	601D398F6R3HE1	0.875 x 1.125		0.118	2.09
8200	601D828F6R3HJ1	0.875 x 1.625		0.059	3.38
12 000	601D129F6R3HL1	0.875 x 2.125		0.042	4.47
15 000	601D159F6R3HP1	0.875 x 2.625		0.033	5.54
18 000	601D189F6R3HS1	0.875 x 3.125		0.027	6.56
22 000	601D229F6R3HT1	0.875 x 3.625		0.023	7.52
5600	601D568F6R3JE1	1.000 x 1.125		0.093	2.57
10 000	601D109F6R3JJ1	1.000 x 1.625		0.049	4.05
18 000	601D189F6R3JL1	1.000 x 2.125		0.033	5.44
22 000	601D229F6R3JP1	1.000 x 2.625	0.026	6.72	
27 000	601D279F6R3JS1	1.000 x 3.125	0.022	7.86	
33 000	601D339F6R3JT1	1.000 x 3.625	0.019	8.98	
10 WV_{DC} AT +85 °C, SURGE = 15 V					
1000	601D108F010FE1	0.625 x 1.125	No. 20 AWG (0.032)	0.332	1.00
2200	601D228F010FJ1	0.625 x 1.625		0.157	1.70
3300	601D338F010FL1	0.625 x 2.125		0.106	2.31
4700	601D478F010FP1	0.625 x 2.625		0.080	2.94
5600	601D568F010FS1	0.625 x 3.125		0.065	3.52
6800	601D688F010FT1	0.625 x 3.625		0.055	4.11
2200	601D228F010GE1	0.750 x 1.125	No. 18 AWG (0.040)	0.182	1.53
3900	601D398F010GJ1	0.750 x 1.625		0.091	2.50
6800	601D688F010GL1	0.750 x 2.125		0.061	3.40
8200	601D828F010GP1	0.750 x 2.625		0.047	4.25
10 000	601D109F010GS1	0.750 x 3.125		0.041	5.00
12 000	601D129F010GT1	0.750 x 3.625		0.035	5.72
3300	601D338F010HE1	0.875 x 1.125		0.127	2.02
5600	601D568F010HJ1	0.875 x 1.625		0.064	3.26
8200	601D828F010HL1	0.875 x 2.125		0.044	4.38
12 000	601D129F010HP1	0.875 x 2.625		0.036	5.30
15 000	601D159F010HS1	0.875 x 3.125		0.029	6.43
18 000	601D189F010HT1	0.875 x 3.625		0.025	7.37
3900	601D398F010JE1	1.000 x 1.125		0.099	2.49
8200	601D828F010JJ1	1.000 x 1.625		0.050	4.00
13 000	601D139F010JL1	1.000 x 2.125		0.036	5.27
18 000	601D189F010JP1	1.000 x 2.625	0.028	6.45	
22 000	601D229F010JS1	1.000 x 3.125	0.023	7.68	
27 000	601D279F010JT1	1.000 x 3.625	0.020	8.75	



ELECTRICAL DATA AND ORDERING INFORMATION					
CAPACITANCE (μF)	PART NUMBER	NOMINAL CASE SIZE D x L (in)	LEAD DIAMETER W (in)	MAX. ESR AT 120 Hz / 25 °C (Ω)	MAX. RIPPLE CURRENT AT 120 Hz / 85 °C (A)
16 WV_{DC} AT +85 °C, SURGE = 20 V					
820	601D827F016FE1	0.625 x 1.125	No. 20 AWG (0.032)	0.349	0.99
1800	601D188F016FJ1	0.625 x 1.625		0.175	1.62
2700	601D278F016FL1	0.625 x 2.125		0.115	2.23
3300	601D338F016FP1	0.625 x 2.625		0.087	2.83
3900	601D398F016FS1	0.625 x 3.125		0.071	3.37
4700	601D478F016FT1	0.625 x 3.625		0.060	3.94
1500	601D158F016GE1	0.750 x 1.125	No. 18 AWG (0.040)	0.198	1.47
3300	601D338F016GJ1	0.750 x 1.625		0.098	2.40
4700	601D478F016GL1	0.750 x 2.125		0.067	3.26
5600	601D568F016GP1	0.750 x 2.625		0.051	4.07
8200	601D828F016GS1	0.750 x 3.125		0.042	4.87
10 000	601D109F016GT1	0.750 x 3.625		0.036	5.64
2200	601D228F016HE1	0.875 x 1.125		0.139	1.93
4700	601D478F016HJ1	0.875 x 1.625		0.070	3.12
6800	601D688F016HL1	0.875 x 2.125		0.048	4.20
10 000	601D109F016HP1	0.875 x 2.625		0.037	5.23
12 000	601D129F016HS1	0.875 x 3.125		0.031	6.19
15 000	601D159F016HT1	0.875 x 3.625		0.027	7.06
3300	601D338F016JE1	1.000 x 1.125		0.108	2.38
6800	601D688F016JJ1	1.000 x 1.625		0.055	3.83
10 000	601D109F016JL1	1.000 x 2.125	0.038	5.10	
25 WV_{DC} AT +85 °C, SURGE = 40 V					
560	601D567F025FE1	0.625 x 1.125	No. 20 AWG (0.032)	0.383	0.94
1000	601D108F025FJ1	0.625 x 1.625		0.198	1.52
1500	601D158F025FL1	0.625 x 2.125		0.125	2.14
2200	601D228F025FP1	0.625 x 2.625		0.096	2.68
2700	601D278F025FS1	0.625 x 3.125		0.078	3.22
3300	601D338F025FT1	0.625 x 3.625		0.065	3.79
1000	601D108F025GE1	0.750 x 1.125	No. 18 AWG (0.040)	0.213	1.41
1800	601D188F025GJ1	0.750 x 1.625		0.110	2.27
2700	601D278F025GL1	0.750 x 2.125		0.073	3.11
3900	601D398F025GP1	0.750 x 2.625		0.056	3.91
4700	601D478F025GS1	0.750 x 3.125		0.045	4.68
5600	601D568F025GT1	0.750 x 3.625		0.038	5.43
1500	601D158F025HE1	0.875 x 1.125		0.157	1.81
2700	601D278F025HJ1	0.875 x 1.625		0.076	2.98
3900	601D398F025HL1	0.875 x 2.125		0.052	4.04
5600	601D568F025HP1	0.875 x 2.625		0.040	5.04
6800	601D688F025HS1	0.875 x 3.125		0.033	6.00
8200	601D828F025HT1	0.875 x 3.625		0.028	6.91
1800	601D188F025JE1	1.000 x 1.125		0.117	2.28
3900	601D398F025JJ1	1.000 x 1.625		0.059	3.70
5600	601D568F025JL1	1.000 x 2.125		0.040	4.96
8200	601D828F025JP1	1.000 x 2.625		0.031	6.14
10 000	601D109F025JS1	1.000 x 3.125	0.027	7.15	
12 000	601D129F025JT1	1.000 x 3.625	0.023	8.21	



ELECTRICAL DATA AND ORDERING INFORMATION					
CAPACITANCE (μF)	PART NUMBER	NOMINAL CASE SIZE D x L (in)	LEAD DIAMETER W (in)	MAX. ESR AT 120 Hz / 25 °C (Ω)	MAX. RIPPLE CURRENT AT 120 Hz / 85 °C (A)
35 WV_{DC} AT +85 °C, SURGE = 50 V					
330	601D337F035FE1	0.625 x 1.125	No. 20 AWG (0.032)	0.480	0.84
680	601D687F035FJ1	0.625 x 1.625		0.231	1.40
1000	601D108F035FL1	0.625 x 2.125		0.154	1.93
1500	601D158F035FP1	0.625 x 2.625		0.118	2.42
1800	601D188F035FS1	0.625 x 3.125		0.095	2.91
2200	601D228F035FT1	0.625 x 3.625		0.080	3.40
680	601D687F035GE1	0.750 x 1.125	No. 18 AWG (0.040)	0.266	1.26
1200	601D128F035GJ1	0.750 x 1.625		0.133	2.06
2200	601D228F035GL1	0.750 x 2.125		0.087	2.84
2700	601D278F035GP1	0.750 x 2.625		0.068	3.52
3300	601D338F035GS1	0.750 x 3.125		0.054	4.25
3900	601D398F035GT1	0.750 x 3.625		0.046	4.95
1000	601D108F035HE1	0.875 x 1.125		0.182	1.68
2200	601D228F035HJ1	0.875 x 1.625		0.091	2.73
2700	601D278F035HL1	0.875 x 2.125		0.062	3.67
3900	601D398F035HP1	0.875 x 2.625		0.047	4.61
4700	601D478F035HS1	0.875 x 3.125		0.039	5.46
5600	601D568F035HT1	0.875 x 3.625		0.033	6.33
1200	601D128F035JE1	1.000 x 1.125		0.146	2.04
2700	601D278F035JJ1	1.000 x 1.625		0.071	3.35
3900	601D398F035JL1	1.000 x 2.125		0.048	4.52
5600	601D568F035JP1	1.000 x 2.625		0.037	5.62
6800	601D688F035JS1	1.000 x 3.125	0.030	6.66	
8200	601D828F035JT1	1.000 x 3.625	0.026	7.66	
50 WV_{DC} AT +85 °C, SURGE = 75 V					
270	601D277F050FE1	0.625 x 1.125	No. 20 AWG (0.032)	0.519	0.81
470	601D477F050FJ1	0.625 x 1.625		0.249	1.35
680	601D687F050FL1	0.625 x 2.125		0.165	1.87
1000	601D108F050FP1	0.625 x 2.625		0.128	2.33
1200	601D128F050FS1	0.625 x 3.125		0.107	2.76
1500	601D158F050FT1	0.625 x 3.625		0.087	3.28
470	601D477F050GE1	0.750 x 1.125	No. 18 AWG (0.040)	0.285	1.22
1000	601D108F050GJ1	0.750 x 1.625		0.139	2.02
1500	601D158F050GL1	0.750 x 2.125		0.095	2.73
1800	601D188F050GP1	0.750 x 2.625		0.071	3.45
2200	601D228F050GS1	0.750 x 3.125		0.060	4.08
2700	601D278F050GT1	0.750 x 3.625		0.050	4.76
680	601D687F050HE1	0.875 x 1.125		0.196	1.62
1500	601D158F050HJ1	0.875 x 1.625		0.099	2.63
2200	601D228F050HL1	0.875 x 2.125		0.067	3.55
2700	601D278F050HP1	0.875 x 2.625		0.051	4.44
3300	601D338F050HS1	0.875 x 3.125		0.042	5.28
3900	601D398F050HT1	0.875 x 3.625		0.036	6.12
1000	601D108F050JE1	1.000 x 1.125		0.148	2.03
1800	601D188F050JJ1	1.000 x 1.625		0.077	3.23
2700	601D278F050JL1	1.000 x 2.125		0.052	4.37
3900	601D398F050JP1	1.000 x 2.625		0.040	5.44
4700	601D478F050JS1	1.000 x 3.125	0.033	6.47	
5600	601D568F050JT1	1.000 x 3.625	0.028	7.45	



ELECTRICAL DATA AND ORDERING INFORMATION					
CAPACITANCE (μF)	PART NUMBER	NOMINAL CASE SIZE D x L (in)	LEAD DIAMETER W (in)	MAX. ESR AT 120 Hz / 25 °C (Ω)	MAX. RIPPLE CURRENT AT 120 Hz / 85 °C (A)
63 WV_{DC} AT +85 °C, SURGE = 90 V					
220	601D227F063FE1	0.625 x 1.125	No. 20 AWG (0.032)	0.563	0.78
470	601D477F063FJ1	0.625 x 1.625		0.269	1.30
680	601D687F063FL1	0.625 x 2.125		0.178	1.80
820	601D827F063FP1	0.625 x 2.625		0.134	2.27
1000	601D108F063FS1	0.625 x 3.125		0.111	2.70
1200	601D128F063FT1	0.625 x 3.625		0.095	3.13
390	601D397F063GE1	0.750 x 1.125	No. 18 AWG (0.040)	0.304	1.18
820	601D827F063GJ1	0.750 x 1.625		0.150	1.94
1200	601D128F063GL1	0.750 x 2.125		0.105	2.59
1500	601D158F063GP1	0.750 x 2.625		0.080	3.26
1800	601D188F063GS1	0.750 x 3.125		0.062	3.99
2200	601D228F063GT1	0.750 x 3.625		0.053	4.62
680	601D687F063HE1	0.875 x 1.125		0.210	1.57
1200	601D128G063HJ1	0.875 x 1.625		0.109	2.50
1800	601D188F063HL1	0.875 x 2.125		0.070	3.47
2200	601D228F063HP1	0.875 x 2.625		0.054	4.31
2700	601D278F063HS1	0.875 x 3.125		0.045	5.12
3900	601D398F063HT1	0.875 x 3.625		0.038	5.98
820	601D827F063JE1	1.000 x 1.125		0.158	1.97
1800	601D188F063JJ1	1.000 x 1.625		0.081	3.14
2700	601D278F063JL1	1.000 x 2.125		0.055	4.25
3300	601D338F063JP1	1.000 x 2.625		0.042	5.31
3900	601D398F063JS1	1.000 x 3.125	0.034	6.31	
4700	601D478F063JT1	1.000 x 3.625	0.029	7.29	
100 WV_{DC} AT +85 °C, SURGE = 150 V					
68	601D686F100FE1	0.625 x 1.125	No. 20 AWG (0.032)	1.714	0.444
120	601D127F100FJ1	0.625 x 1.625		0.869	0.725
180	601D187F100FL1	0.625 x 2.125		0.561	1.010
270	601D277F100FP1	0.625 x 2.625		0.415	1.290
330	601D337F100FS1	0.625 x 3.125		0.330	1.570
390	601D397F100FT1	0.625 x 3.625		0.274	1.840
120	601D127F100GE1	0.750 x 1.125	No. 18 AWG (0.040)	0.986	0.656
270	601D277F100GJ1	0.750 x 1.625		0.461	1.110
390	601D387F100GL1	0.750 x 2.125		0.302	1.530
470	601D477F100GP1	0.750 x 2.625		0.230	1.920
560	601D567F100GS1	0.750 x 3.125		0.183	2.330
680	601D687F100GT1	0.750 x 3.625		0.152	2.730
180	601D187F100HE1	0.875 x 1.125		0.632	0.903
390	601D397F100HJ1	0.875 x 1.625		0.308	1.490
560	601D567F100HL1	0.875 x 2.125		0.205	2.030
680	601D687F100HP1	0.875 x 2.625		0.155	2.560
820	601D827F100HS1	0.875 x 3.125		0.124	3.080
1000	601D108F100HT1	0.875 x 3.625		0.108	3.530
270	601D277F100JE1	1.000 x 1.125		0.469	1.140
470	601D477F100JJ1	1.000 x 1.625		0.226	1.880
820	601D827F100JL1	1.000 x 2.125		0.152	2.560
1000	601D108F100JP1	1.000 x 2.625		0.120	3.140
1200	601D128F100JS1	1.000 x 3.125	0.093	3.830	
1500	601D157F100JT1	1.000 x 3.625	0.081	4.370	



ELECTRICAL DATA AND ORDERING INFORMATION					
CAPACITANCE (μF)	PART NUMBER	NOMINAL CASE SIZE D x L (in)	LEAD DIAMETER W (in)	MAX. ESR AT 120 Hz / 25 °C (Ω)	MAX. RIPPLE CURRENT AT 120 Hz / 85 °C (A)
150 WV_{DC} AT +85 °C, SURGE = 200 V					
33	601D336F150FE1	0.625 x 1.125	No. 20 AWG (0.032)	3.518	0.310
68	601D686F150FJ1	0.625 x 1.625		1.677	0.522
100	601D107F150FL1	0.625 x 2.125		1.114	0.718
120	601D127F150FP1	0.625 x 2.625		0.842	0.907
150	601D157F150FS1	0.625 x 3.125		0.672	1.100
180	601D187F150FT1	0.625 x 3.625		0.560	1.290
56	601D566F150GE1	0.750 x 1.125	No. 18 AWG (0.040)	2.089	0.451
100	601D107F150GJ1	0.750 x 1.625		1.033	0.740
150	601D157F150GL1	0.750 x 2.125		0.683	1.020
220	601D227F150GP1	0.750 x 2.625		0.511	1.290
270	601D277F150GS1	0.750 x 3.125		0.409	1.560
330	601D337F150GT1	0.750 x 3.625		0.341	1.820
82	601D826F150HE1	0.875 x 1.125		1.395	0.608
150	601D157F150HJ1	0.875 x 1.625		0.695	0.989
270	601D277F150HL1	0.875 x 2.125		0.451	1.370
330	601D337F150HP1	0.875 x 2.625		0.345	1.710
390	601D397F150HS1	0.875 x 3.125		0.273	2.080
470	601D477F150HT1	0.875 x 3.625		0.226	2.440
100	601D107F150JE1	1.000 x 1.125		1.082	0.753
220	601D227F150JJ1	1.000 x 1.625		0.502	1.260
330	601D337F150JL1	1.000 x 2.125	0.328	1.740	
470	601D477F150JP1	1.000 x 2.625	0.244	2.200	
560	601D567F150JS1	1.000 x 3.125	0.195	2.650	
680	601D687F150JT1	1.000 x 3.625	0.165	3.070	
200 WV_{DC} AT +85 °C, SURGE = 250 V					
27	601D276F200FE1	0.625 x 1.125	No. 20 AWG (0.032)	3.985	0.292
56	601D566F200FJ1	0.625 x 1.625		1.892	0.491
82	601D826F200FL1	0.625 x 2.125		1.242	0.680
100	601D107F200FP1	0.625 x 2.625		0.925	0.865
120	601D127F200FS1	0.625 x 3.125		0.761	1.032
150	601D157F200FT1	0.625 x 3.625		0.651	1.190
47	601D476F200GE1	0.750 x 1.125	No. 18 AWG (0.040)	2.354	0.424
82	601D826F200GJ1	0.750 x 1.625		1.142	0.704
120	601D127F200GL1	0.750 x 2.125		0.774	0.956
180	601D187F200GP1	0.750 x 2.625		0.578	1.210
220	601D227F200GS1	0.750 x 3.125		0.462	1.460
270	601D277F200GT1	0.750 x 3.625		0.385	1.710
120	601D127F200HJ1	0.875 x 1.625		0.787	0.930
180	601D187F200HL1	0.875 x 2.125		0.521	1.270
270	601D277F200HP1	0.875 x 2.625		0.390	1.610
330	601D337F200HS1	0.875 x 3.125		0.302	1.970
390	601D397F200HT1	0.875 x 3.625		0.254	2.300
82	601D826F200JE1	1.000 x 1.125		1.128	0.737
180	601D187F200JJ1	1.000 x 1.625		0.560	1.200
270	601D277F200JL1	1.000 x 2.125		0.365	1.650
390	601D397F200JP1	1.000 x 2.625	0.278	2.060	
470	601D477F200JS1	1.000 x 3.125	0.221	2.490	
560	601D567F200JT1	1.000 x 3.625	0.183	2.910	



ELECTRICAL DATA AND ORDERING INFORMATION					
CAPACITANCE (μF)	PART NUMBER	NOMINAL CASE SIZE D x L (in)	LEAD DIAMETER W (in)	MAX. ESR AT 120 Hz / 25 °C (Ω)	MAX. RIPPLE CURRENT AT 120 Hz / 85 °C (A)
250 WV_{DC} AT +85 °C, SURGE = 300 V					
15	601D156F250FE1	0.625 x 1.125	No. 20 AWG (0.032)	7.136	0.22
33	601D336F250FJ1	0.625 x 1.625		3.228	0.38
47	601D476F250FL1	0.625 x 2.125		2.132	0.52
68	601D686F250FP1	0.625 x 2.625		1.591	0.66
82	601D826F250FS1	0.625 x 3.125		1.270	0.80
100	601D107F250FT1	0.625 x 3.625		1.057	0.94
27	601D276F250GE1	0.750 x 1.125	No. 18 AWG (0.040)	3.614	0.34
56	601D566F250GJ1	0.750 x 1.625		1.721	0.57
100	601D107F250GL1	0.750 x 2.125		1.130	0.79
120	601D127F250GP1	0.750 x 2.625		0.880	0.98
150	601D157F250GS1	0.750 x 3.125		0.690	1.20
180	601D187F250GT1	0.750 x 3.625		0.568	1.41
47	601D476F250HE1	0.875 x 1.125		2.369	0.47
100	601D107F250HJ1	0.875 x 1.625		1.148	0.77
150	601D157F250HL1	0.875 x 2.125		0.753	1.06
180	601D187F250HP1	0.875 x 2.625		0.574	1.33
220	601D227F250HS1	0.875 x 3.125		0.464	1.59
270	601D277F250HT1	0.875 x 3.625		0.375	1.89
56	601D566F250JE1	1.000 x 1.125		1.708	0.60
120	601D127F250JJ1	1.000 x 1.625		0.829	0.98
180	601D187F250JL1	1.000 x 2.125		0.548	1.34
270	601D277F250JP1	1.000 x 2.625		0.410	1.69
330	601D337F250JS1	1.000 x 3.125		0.328	2.04
390	601D397F250JT1	1.000 x 3.625		0.274	2.38
300 WV_{DC} AT +85 °C, SURGE = 350 V					
12	601D126F300FE1	0.625 x 1.125	No. 20 AWG (0.032)	8.217	0.20
27	601D276F300FJ1	0.625 x 1.625		3.809	0.35
39	601D396F300FL1	0.625 x 2.125		2.479	0.48
47	601D476F300FP1	0.625 x 2.625		1.839	0.61
56	601D566F300FS1	0.625 x 3.125		1.461	0.75
68	601D686F300FT1	0.625 x 3.625		1.231	0.87
22	601D226F300GE1	0.750 x 1.125	No. 18 AWG (0.040)	4.164	0.32
47	601D476F300GJ1	0.750 x 1.625		1.931	0.54
68	601D686F300GL1	0.750 x 2.125		1.294	0.74
100	601D107F300GP1	0.750 x 2.625		0.953	0.94
120	601D127F300GS1	0.750 x 3.125		0.795	1.12
150	601D157F300GT1	0.750 x 3.625		0.672	1.30
33	601D336F300HE1	0.875 x 1.125		2.712	0.44
68	601D686F300HJ1	0.875 x 1.625		1.296	0.72
100	601D107F300HL1	0.875 x 2.125		0.886	0.98
150	601D157F300HP1	0.875 x 2.625		0.679	1.22
180	601D187F300HS1	0.875 x 3.125		0.519	1.50
220	601D227F300HT1	0.875 x 3.625		0.441	1.74
47	601D476F300JE1	1.000 x 1.125		1.973	0.56
100	601D107F300JJ1	1.000 x 1.625		0.947	0.92
150	601D157F300JL1	1.000 x 2.125		0.637	1.25
180	601D187F300JP1	1.000 x 2.625		0.468	1.59
220	601D227F300JS1	1.000 x 3.125		0.386	1.88
270	601D277F300JT1	1.000 x 3.625		0.318	2.21

Statements about product lifetime are based on calculations and internal testing. They should only be interpreted as estimations. Also due to external factors, the lifetime in the field application may deviate from the calculated lifetime. In general, nothing stated herein shall be construed as a guarantee of durability.



Disclaimer

ALL PRODUCT, PRODUCT SPECIFICATIONS AND DATA ARE SUBJECT TO CHANGE WITHOUT NOTICE TO IMPROVE RELIABILITY, FUNCTION OR DESIGN OR OTHERWISE.

Vishay Intertechnology, Inc., its affiliates, agents, and employees, and all persons acting on its or their behalf (collectively, "Vishay"), disclaim any and all liability for any errors, inaccuracies or incompleteness contained in any datasheet or in any other disclosure relating to any product.

Vishay makes no warranty, representation or guarantee regarding the suitability of the products for any particular purpose or the continuing production of any product. To the maximum extent permitted by applicable law, Vishay disclaims (i) any and all liability arising out of the application or use of any product, (ii) any and all liability, including without limitation special, consequential or incidental damages, and (iii) any and all implied warranties, including warranties of fitness for particular purpose, non-infringement and merchantability.

Statements regarding the suitability of products for certain types of applications are based on Vishay's knowledge of typical requirements that are often placed on Vishay products in generic applications. Such statements are not binding statements about the suitability of products for a particular application. It is the customer's responsibility to validate that a particular product with the properties described in the product specification is suitable for use in a particular application. Parameters provided in datasheets and / or specifications may vary in different applications and performance may vary over time. All operating parameters, including typical parameters, must be validated for each customer application by the customer's technical experts. Product specifications do not expand or otherwise modify Vishay's terms and conditions of purchase, including but not limited to the warranty expressed therein.

Hyperlinks included in this datasheet may direct users to third-party websites. These links are provided as a convenience and for informational purposes only. Inclusion of these hyperlinks does not constitute an endorsement or an approval by Vishay of any of the products, services or opinions of the corporation, organization or individual associated with the third-party website. Vishay disclaims any and all liability and bears no responsibility for the accuracy, legality or content of the third-party website or for that of subsequent links.

Except as expressly indicated in writing, Vishay products are not designed for use in medical, life-saving, or life-sustaining applications or for any other application in which the failure of the Vishay product could result in personal injury or death. Customers using or selling Vishay products not expressly indicated for use in such applications do so at their own risk. Please contact authorized Vishay personnel to obtain written terms and conditions regarding products designed for such applications.

No license, express or implied, by estoppel or otherwise, to any intellectual property rights is granted by this document or by any conduct of Vishay. Product names and markings noted herein may be trademarks of their respective owners.