

Hermetic, Dual-In-Line Packaged Thin Film Resistor, Through Hole Networks

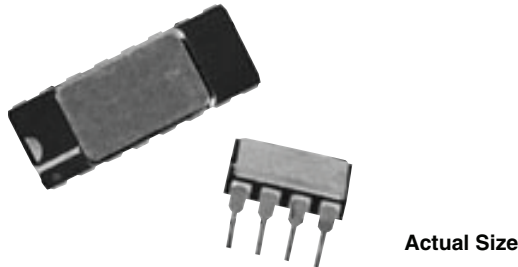

DESIGN SUPPORT TOOLS

[click logo to get started](#)



The superstable RMKD nickel-chromium integrated networks are available in a range of standard designs which bring a completely new “state-of-the-art” to precision network performance criteria.

Circuit designers can now incorporate into their circuitry the ultimate in today’s performance characteristics as “standards”, without needing to call out specially engineered designs at premium prices.

SCHEMATIC

Standard Configuration, 8 Leads Hermetic DIL

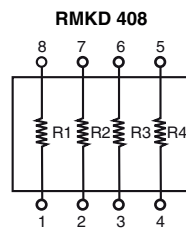

4 Equal and Independent Resistors

Standard Configuration, 14 Leads Hermetic DIL

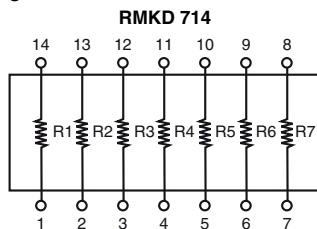

7 Equal and Independent Resistors

Standard Configuration, 16 Leads Hermetic DIL

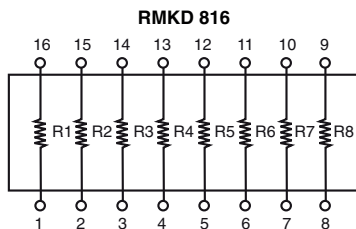

8 Equal and Independent Resistors

Notes

- For different values in a network a specific part number is used: CNPxxxx. Please consult Vishay Sfernice
- For values outside ohmic range please consult Vishay Sfernice

FEATURES

- 500 Ω to 200 kΩ
- High stability: < 300 ppm maximum, 2000 h at Pn at +70 °C
- Gold terminal
- Hermetic cases: Dual-in-line
- Through hole
- Custom available (CNP)
- Material categorization: for definitions of compliance please see www.vishay.com/doc?99912



TYPICAL PERFORMANCE

	ABS	TRACKING
TCR	10 ppm/°C	1 ppm/°C
	ABS	RATIO
TOL.	0.05 %	0.02 %

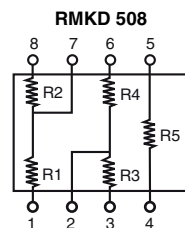

Dual Divider Feedback Network with Equal Value Resistors

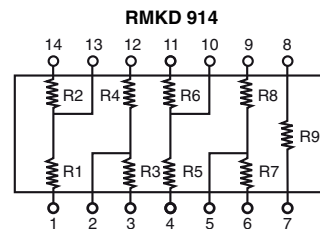

Quad Divider Feedback Network with Equal Value Resistors

STANDARD ELECTRICAL SPECIFICATIONS

MODEL	RESISTANCE RANGE Ω	POWER RATING ⁽¹⁾ W	ABSOLUTE TOLERANCE \pm %	RATIO TOLERANCE %	ABSOLUTE TCR ⁽²⁾ \pm ppm/ $^{\circ}$ C	RATIO TCR ⁽³⁾ \pm ppm/ $^{\circ}$ C
RMKD 408	500 to 200K	0.125	0.05, 0.1	0.01, 0.02, 0.05	5, 10	1, 2
RMKD 508	500 to 200K	0.250	0.05, 0.1	0.01, 0.02, 0.05	5, 10	1, 2
RMKD 714	500 to 200K	0.250	0.05, 0.1	0.01, 0.02, 0.05	5, 10	1, 2
RMKD 816	500 to 200K	0.250	0.05, 0.1	0.01, 0.02, 0.05	5, 10	1, 2
RMKD 914	500 to 200K	0.250	0.05, 0.1	0.01, 0.02, 0.05	5, 10	1, 2

Notes

- (1) Per Package at +70 $^{\circ}$ C
 (2) \pm 5 ppm/ $^{\circ}$ C typical at 0 $^{\circ}$ C to +70 $^{\circ}$ C, \pm 10 ppm/ $^{\circ}$ C maximum at -55 $^{\circ}$ C to +155 $^{\circ}$ C
 (3) At -55 $^{\circ}$ C to +155 $^{\circ}$ C

PERFORMANCES

TEST	SPECIFICATIONS	CONDITIONS
CONFIGURATIONS	RMKD 408, RMKD 508, RMKD 714, RMKD 816, RMKD 914	
Stability (ΔR ratio)	< 300 ppm maximum	2000 h at +70 $^{\circ}$ C at Pn
Working voltage	100 V _{CC} on R	
Operating temperature range	-55 $^{\circ}$ C to +155 $^{\circ}$ C	
Storage temperature range	-55 $^{\circ}$ C to +155 $^{\circ}$ C	
Noise	-35 dB typical	MIL-STD-202, model 308
Thermal EMF	< 0.1 μ V/ $^{\circ}$ C	

DIMENSIONS

RMKD 408 and RMKD 508

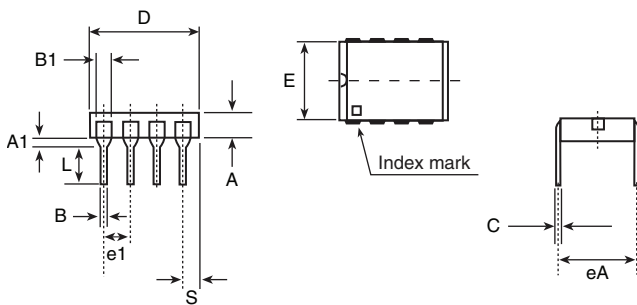

DIMENSION	INCHES	MILLIMETERS
D	0.401	10.20 \pm 0.10
B1	0.046	1.19
A1	0.035	0.89 \pm 0.25
A	0.086	2.20 \pm 0.20
L	0.129 minimum	3.30 minimum
B	0.018	0.46 \pm 0.05
e1	0.100	2.54 \pm 0.10
S	0.050	1.27 \pm 0.50
E	0.290	7.37 \pm 0.20
C	0.009	0.25 \pm 0.05
eA	0.300	7.62 \pm 0.20

RMKD 714 and RMKD 914

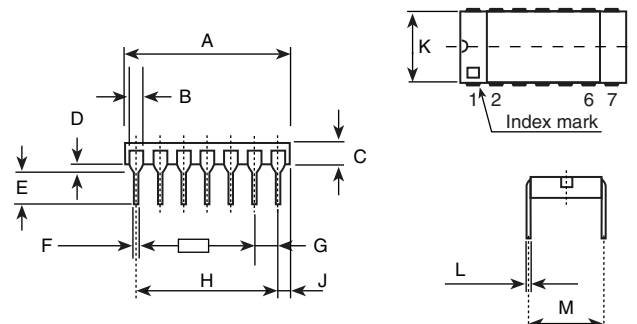

DIMENSION	INCHES	MILLIMETERS
A	0.700	17.78 \pm 0.20
B	0.046	1.19
C	0.086	2.20 \pm 0.20
D	0.035	0.89 \pm 0.25
E	0.129	3.30
F	0.018	0.46 \pm 0.05
G	0.100	2.54 \pm 0.10
H	0.600	15.24 \pm 0.10
J	0.050	1.27 \pm 0.50
K	0.290	7.37 \pm 0.20
L	0.009	0.25 \pm 0.05
M	0.300	7.62 \pm 0.20



DIMENSIONS

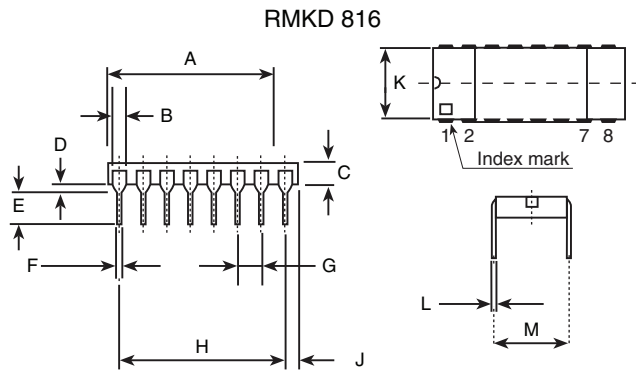

DIMENSION	INCHES	MILLIMETERS
A	0.799	20.30 ± 0.20
B	0.046	1.19
C	0.092	2.35 ± 0.20
D	0.035	0.89 ± 0.25
E	0.129	3.30
F	0.018	0.46 ± 0.05
G	0.100	2.54 ± 0.10
H	0.700	17.78 ± 0.10
J	0.050	1.27 ± 0.50
K	0.290	7.37 ± 0.20
L	0.009	0.25 ± 0.05
M	0.300	7.62 ± 0.20

MECHANICAL SPECIFICATIONS	
Resistive material	Nichrome
Passivation	Mineral passivation Si3N4
Terminals	Gold

Option: tin / silver plating: option 0076

GLOBAL PART NUMBER INFORMATION

New Global Part Numbering: **RMKD408-100KBW0099** (preferred part number format)

R	M	K	D	4	0	8	-	1	0	0	K	B	W	0	0	9	9
---	---	---	---	---	---	---	---	---	---	---	---	---	---	---	---	---	---

GLOBAL MODEL	VALUE	ABS. TOLERANCE	RATIO TOLERANCE	OPTION
RMKD408 RMKD508 RMKD816 RMKD714 RMKD914	Decimal: R, K or M	B = 0.1 % W = 0.05 %	W = 0.05 % P = 0.02 % L = 0.01 %	Leave blank if no option

For custom specification:

CNP	085
GLOBAL MODEL	REFERENCE

Reference is assigned by Vishay Sfernice

Historical Part Number Example: **RMKD408 100K 0.1 % 0.05 % e4** (will continue to be accepted)

RMKD408	100K	0.1 %	0.05 %	e4
HISTORICAL MODEL	OHMIC VALUE	ABS. TOLERANCE	RATIO TOLERANCE	RoHS



Disclaimer

ALL PRODUCT, PRODUCT SPECIFICATIONS AND DATA ARE SUBJECT TO CHANGE WITHOUT NOTICE TO IMPROVE RELIABILITY, FUNCTION OR DESIGN OR OTHERWISE.

Vishay Intertechnology, Inc., its affiliates, agents, and employees, and all persons acting on its or their behalf (collectively, "Vishay"), disclaim any and all liability for any errors, inaccuracies or incompleteness contained in any datasheet or in any other disclosure relating to any product.

Vishay makes no warranty, representation or guarantee regarding the suitability of the products for any particular purpose or the continuing production of any product. To the maximum extent permitted by applicable law, Vishay disclaims (i) any and all liability arising out of the application or use of any product, (ii) any and all liability, including without limitation special, consequential or incidental damages, and (iii) any and all implied warranties, including warranties of fitness for particular purpose, non-infringement and merchantability.

Statements regarding the suitability of products for certain types of applications are based on Vishay's knowledge of typical requirements that are often placed on Vishay products in generic applications. Such statements are not binding statements about the suitability of products for a particular application. It is the customer's responsibility to validate that a particular product with the properties described in the product specification is suitable for use in a particular application. Parameters provided in datasheets and / or specifications may vary in different applications and performance may vary over time. All operating parameters, including typical parameters, must be validated for each customer application by the customer's technical experts. Product specifications do not expand or otherwise modify Vishay's terms and conditions of purchase, including but not limited to the warranty expressed therein.

Hyperlinks included in this datasheet may direct users to third-party websites. These links are provided as a convenience and for informational purposes only. Inclusion of these hyperlinks does not constitute an endorsement or an approval by Vishay of any of the products, services or opinions of the corporation, organization or individual associated with the third-party website. Vishay disclaims any and all liability and bears no responsibility for the accuracy, legality or content of the third-party website or for that of subsequent links.

Except as expressly indicated in writing, Vishay products are not designed for use in medical, life-saving, or life-sustaining applications or for any other application in which the failure of the Vishay product could result in personal injury or death. Customers using or selling Vishay products not expressly indicated for use in such applications do so at their own risk. Please contact authorized Vishay personnel to obtain written terms and conditions regarding products designed for such applications.

No license, express or implied, by estoppel or otherwise, to any intellectual property rights is granted by this document or by any conduct of Vishay. Product names and markings noted herein may be trademarks of their respective owners.