



## Features

- High Blocking Voltage with Low On-Resistance
- High Speed Switching with Low Capacitances
- Easy to Parallel and Simple to Drive
- Avalanche Ruggedness
- Halogen Free, RoHS Compliant

## Benefits

- Higher System Efficiency
- Reduced Cooling Requirements
- Increased Power Density
- Increased System Switching Frequency

## Applications

- Solar Inverters
- Switch Mode Power Supplies
- High Voltage DC/DC Converters
- Battery Chargers
- Motor Drives
- Pulsed Power applications

Part Number	Package
GC2M0080120D1	TO-247-3

$V_{DS}$	1200 V
$I_D @ 25^\circ\text{C}$	34 A
$R_{DS(on)}$	80 m $\Omega$

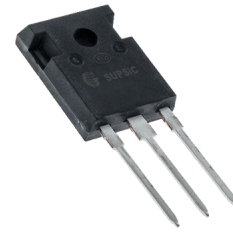

TO-247-3

### Package

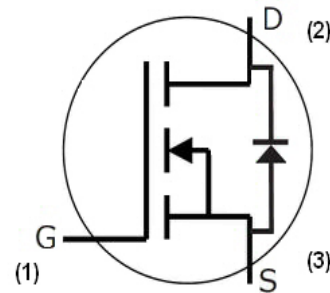

## Maximum Ratings ( $T_C = 25^\circ\text{C}$ unless otherwise specified)

Symbol	Parameter	Value	Unit	Test Conditions	Note
$V_{DSmax}$	Drain - Source Voltage	1200	V	$V_{GS} = 0\text{ V}, I_D = 100\ \mu\text{A}$	
$V_{GSmax}$	Gate - Source Voltage	-10/+25	V	Absolute maximum values	
$V_{GSop}$	Gate - Source Voltage	-5/+20	V	Recommended operational values	
$I_D$	Continuous Drain Current	34	A	$V_{GS} = 20\text{ V}, T_C = 25^\circ\text{C}$	Fig. 19
		24		$V_{GS} = 20\text{ V}, T_C = 100^\circ\text{C}$	
$I_{D(pulse)}$	Pulsed Drain Current	80	A	Pulse width $t_p$ limited by $T_{Jmax}$	Fig. 22
$P_D$	Power Dissipation	190	W	$T_C = 25^\circ\text{C}, T_J = 150^\circ\text{C}$	Fig. 20
$T_J, T_{stg}$	Operating Junction and Storage Temperature	-55 to +150	$^\circ\text{C}$		
$T_L$	Solder Temperature	260	$^\circ\text{C}$	1.6mm (0.063") from case for 10s	
$M_d$	Mounting Torque	1	Nm lbf-in	M3 or 6-32 screw	
		8.8			

**Electrical Characteristics** ( $T_c = 25^\circ\text{C}$  unless otherwise specified)

Symbol	Parameter	Min.	Typ.	Max.	Unit	Test Conditions	Note
$V_{(BR)DSS}$	Drain-Source Breakdown Voltage	1200			V	$V_{GS} = 0\text{ V}, I_D = 100\ \mu\text{A}$	
$V_{GS(th)}$	Gate Threshold Voltage	2.0	2.9	4	V	$V_{DS} = V_{GS}, I_D = 5\ \text{mA}$	Fig. 11
			2.4		V	$V_{DS} = V_{GS}, I_D = 5\ \text{mA}, T_J = 150^\circ\text{C}$	
$I_{DSS}$	Zero Gate Voltage Drain Current		1	100	$\mu\text{A}$	$V_{DS} = 1200\ \text{V}, V_{GS} = 0\ \text{V}$	
$I_{GSS}$	Gate-Source Leakage Current			250	nA	$V_{GS} = 20\ \text{V}, V_{DS} = 0\ \text{V}$	
$R_{DS(on)}$	Drain-Source On-State Resistance		80	98	m $\Omega$	$V_{GS} = 20\ \text{V}, I_D = 20\ \text{A}$	Fig. 4, 5, 6
			144			$V_{GS} = 20\ \text{V}, I_D = 20\ \text{A}, T_J = 150^\circ\text{C}$	
$g_{fs}$	Transconductance		10		S	$V_{DS} = 20\ \text{V}, I_{DS} = 20\ \text{A}$	Fig. 7
			9			$V_{DS} = 20\ \text{V}, I_{DS} = 20\ \text{A}, T_J = 150^\circ\text{C}$	
$C_{iss}$	Input Capacitance		1130		pF	$V_{GS} = 0\ \text{V}$ $V_{DS} = 1000\ \text{V}$ $f = 1\ \text{MHz}$	Fig. 17, 18
$C_{oss}$	Output Capacitance		92				
$C_{rss}$	Reverse Transfer Capacitance		7.5				
$E_{oss}$	$C_{oss}$ Stored Energy		50		$\mu\text{J}$	$V_{AC} = 25\ \text{mV}$	Fig. 16
$E_{AS}$	Avalanche Energy, Single Pulse		1		J	$I_D = 20\ \text{A}, V_{DD} = 50\ \text{V}$	Fig. 29
$E_{ON}$	Turn-On Switching Energy		523		$\mu\text{J}$	$V_{DS} = 800\ \text{V}, V_{GS} = -5/20\ \text{V}, I_D = 20\ \text{A}, R_{G(ext)} = 2.5\ \Omega, L = 156\ \mu\text{H}$	Fig. 25
$E_{OFF}$	Turn Off Switching Energy		72				
$t_{d(on)}$	Turn-On Delay Time		15		ns	$V_{DD} = 800\ \text{V}, V_{GS} = -5/20\ \text{V}$ $I_D = 20\ \text{A}, R_{G(ext)} = 2.5\ \Omega,$ $R_L = 40\ \Omega,$ Timing relative to $V_{DS}$ Per IEC60747-8-4 pg 83	Fig. 27
$t_r$	Rise Time		22				
$t_{d(off)}$	Turn-Off Delay Time		24				
$t_f$	Fall Time		14				
$R_{G(int)}$	Internal Gate Resistance		3.9		$\Omega$	$f = 1\ \text{MHz}, V_{AC} = 25\ \text{mV}$	
$Q_{gs}$	Gate to Source Charge		17		nC	$V_{DS} = 800\ \text{V}, V_{GS} = -5/20\ \text{V}$ $I_D = 20\ \text{A}$ Per IEC60747-8-4 pg 21	Fig. 12
$Q_{gd}$	Gate to Drain Charge		29				
$Q_g$	Total Gate Charge		71				

**Reverse Diode Characteristics**

Symbol	Parameter	Typ.	Max.	Unit	Test Conditions	Note
$V_{SD}$	Diode Forward Voltage	4.3		V	$V_{GS} = -5\ \text{V}, I_{SD} = 10\ \text{A}$	Fig. 8, 9, 10
		3.8		V	$V_{GS} = -5\ \text{V}, I_{SD} = 10\ \text{A}, T_J = 150^\circ\text{C}$	
$I_S$	Continuous Diode Forward Current		34	A	$T_c = 25^\circ\text{C}$	Note 1
$t_{rr}$	Reverse Recover time	24		ns	$V_{GS} = -5\ \text{V}, I_{SD} = 20\ \text{A}, V_R = 800\ \text{V}$ $\text{dif}/\text{dt} = 1950\ \text{A}/\mu\text{s}$	Note 1
$Q_{rr}$	Reverse Recovery Charge	152		nC		
$I_{rrm}$	Peak Reverse Recovery Current	10		A		

Note (1): When using SiC Body Diode the maximum recommended  $V_{GS} = -5\text{V}$

**Thermal Characteristics**

Symbol	Parameter	Typ.	Max.	Unit	Test Conditions	Note
$R_{\theta JC}$	Thermal Resistance from Junction to Case	0.60	0.65	$^\circ\text{C}/\text{W}$		Fig. 21
$R_{\theta JA}$	Thermal Resistance From Junction to Ambient		40			

Typical Performance

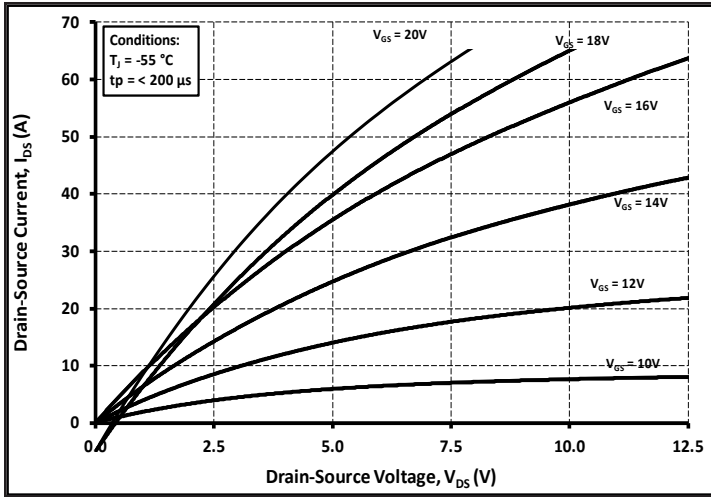

Figure 1. Output Characteristics  $T_J = -55\text{ }^\circ\text{C}$

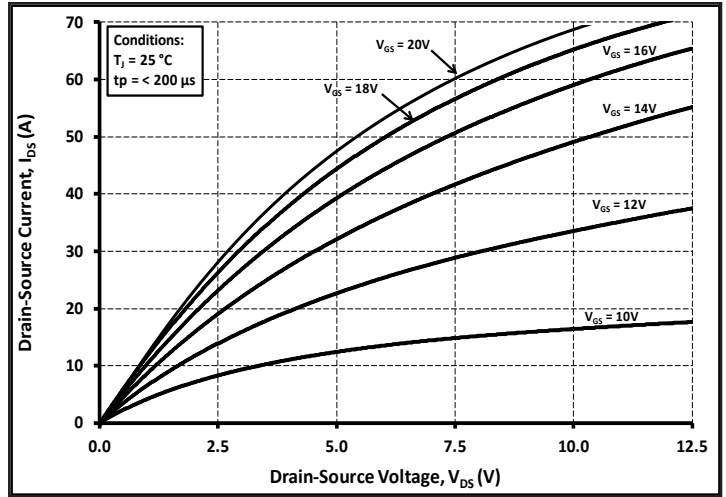

Figure 2. Output Characteristics  $T_J = 25\text{ }^\circ\text{C}$

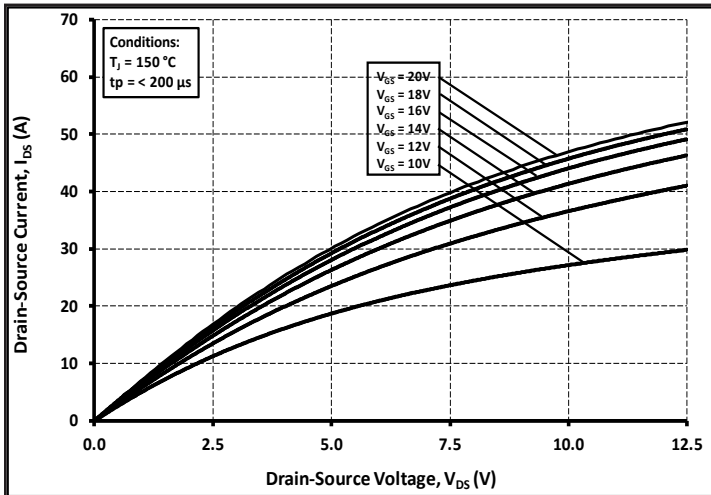

Figure 3. Output Characteristics  $T_J = 150\text{ }^\circ\text{C}$

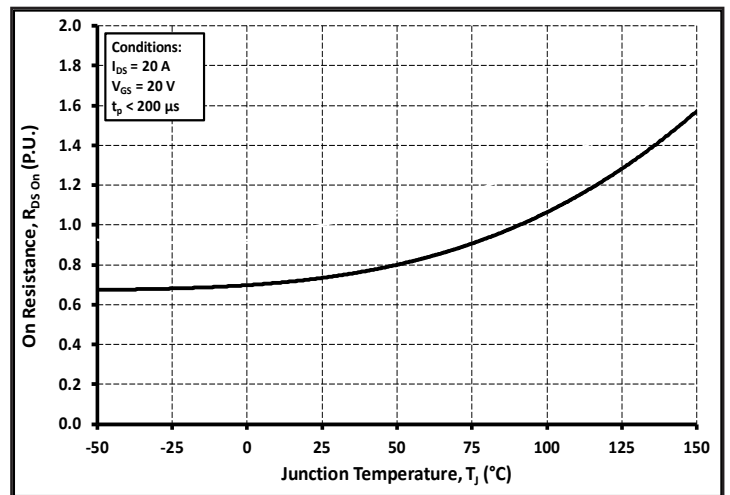

Figure 4. Normalized On-Resistance vs. Temperature

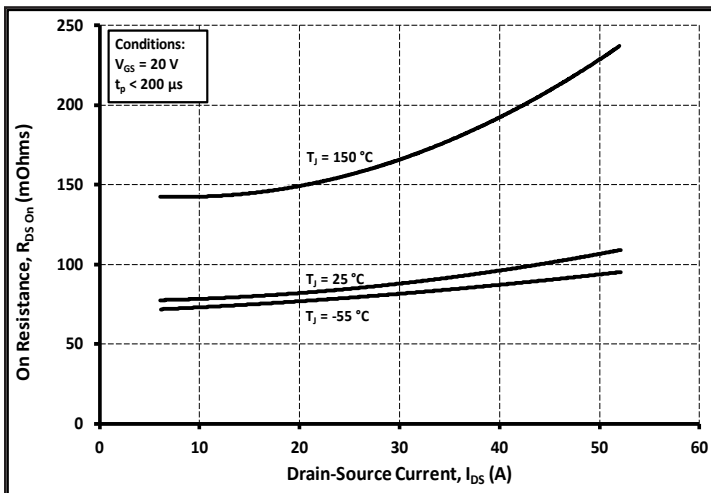

Figure 5. On-Resistance vs. Drain Current For Various Temperatures

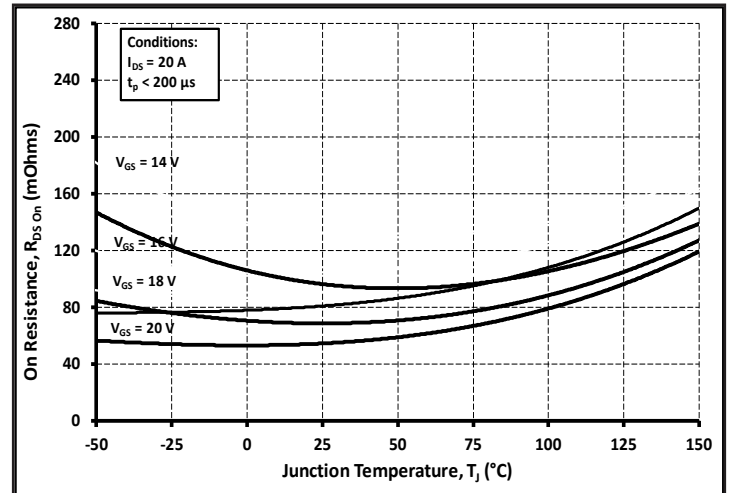

Figure 6. On-Resistance vs. Temperature For Various Gate Voltage

Typical Performance

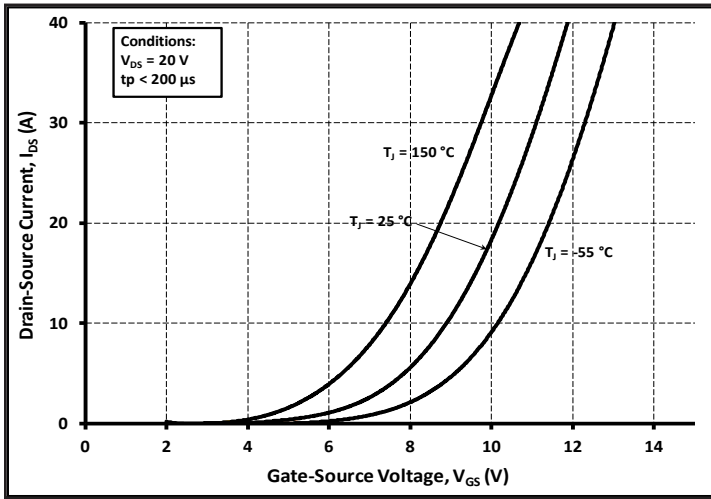

Figure 7. Transfer Characteristic for Various Junction Temperatures

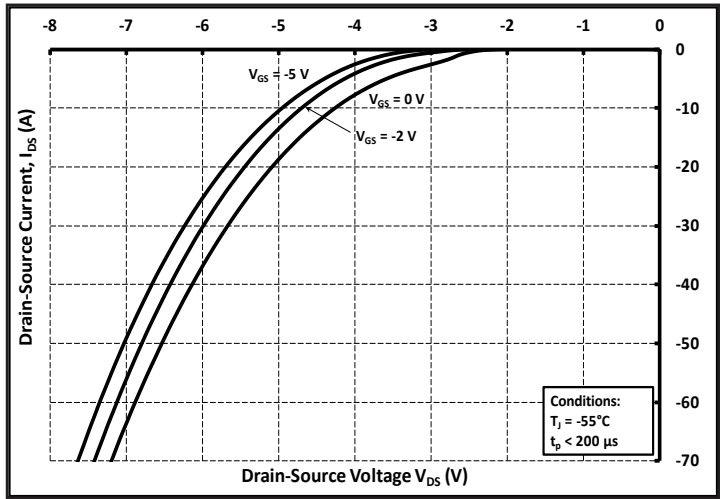

Figure 8. Body Diode Characteristic at -55 °C

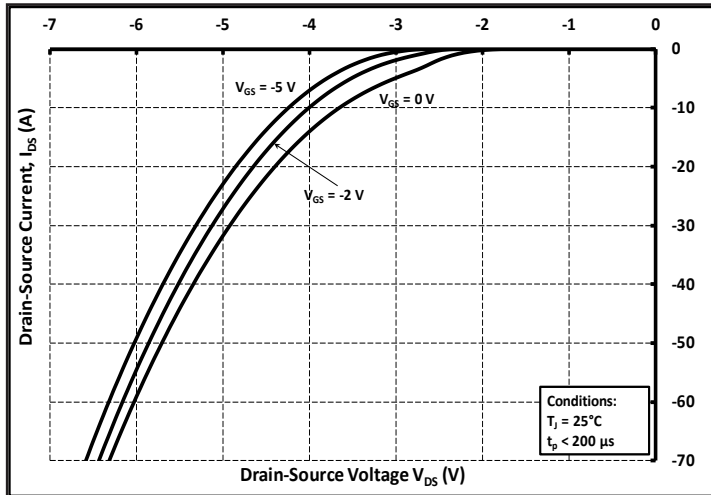

Figure 9. Body Diode Characteristic at 25 °C

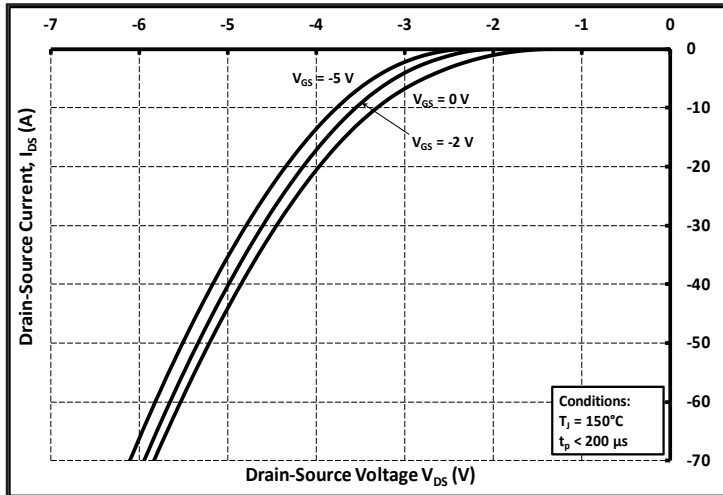

Figure 10. Body Diode Characteristic at 150 °C

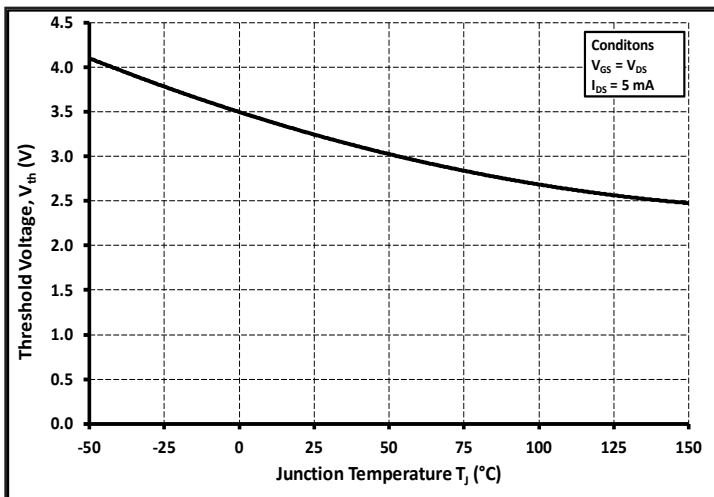

Figure 11. Threshold Voltage vs. Temperature

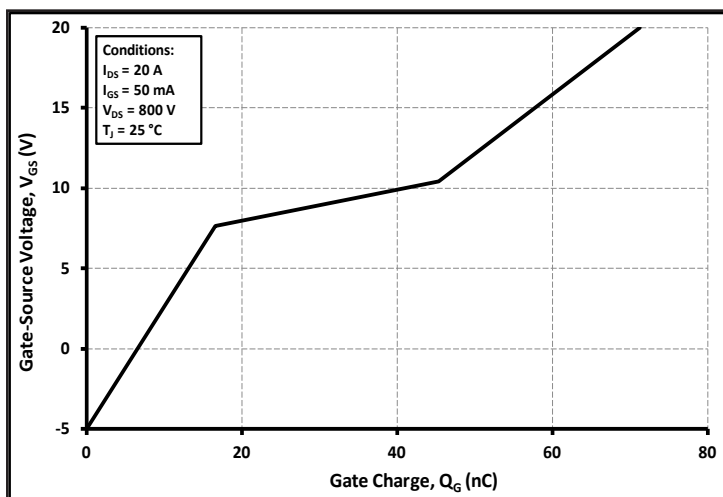

Figure 12. Gate Charge Characteristics

Typical Performance

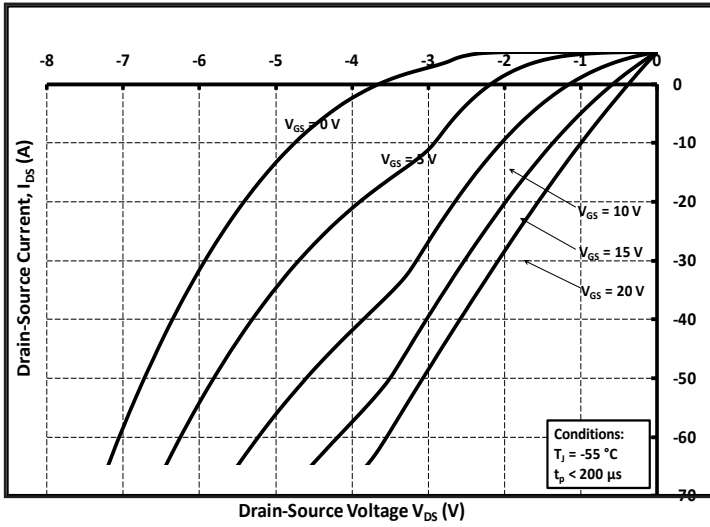

Figure 13. 3rd Quadrant Characteristic at -55 °C

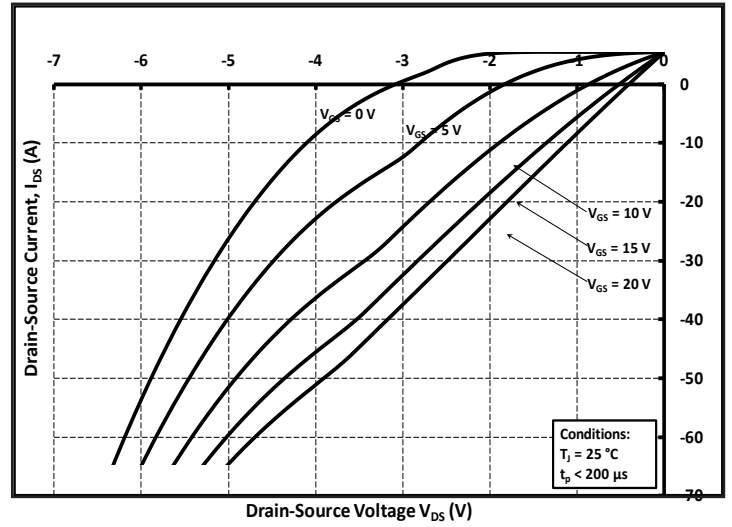

Figure 14. 3rd Quadrant Characteristic at 25 °C

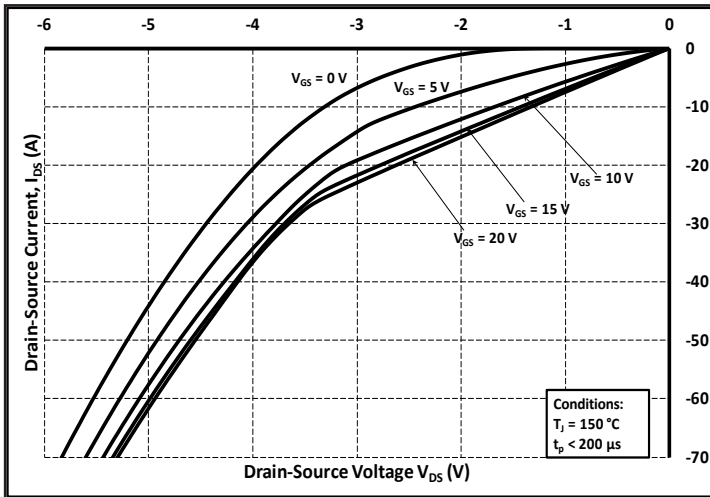

Figure 15. 3rd Quadrant Characteristic at 150 °C

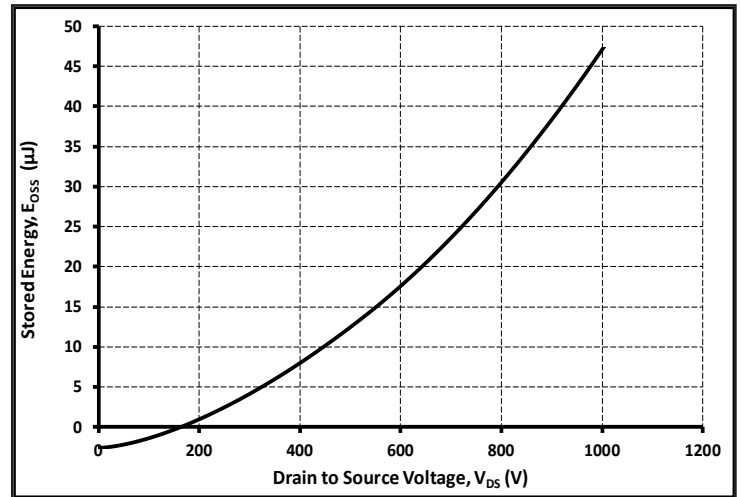

Figure 16. Output Capacitor Stored Energy

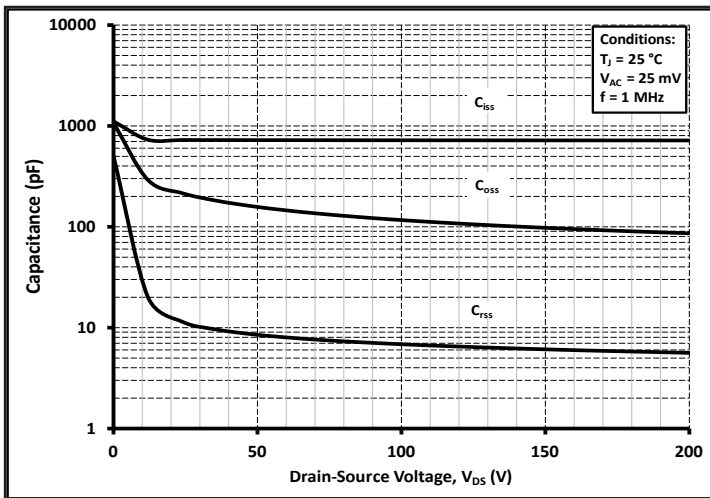

Figure 17. Capacitances vs. Drain-Source Voltage (0 - 200V)

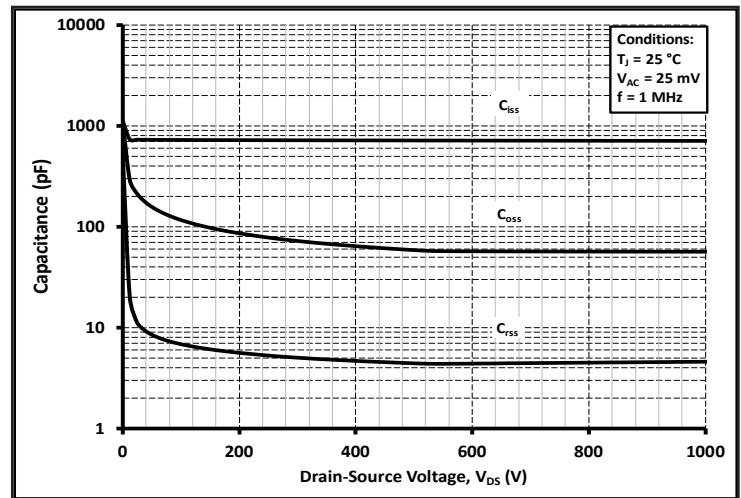

Figure 18. Capacitances vs. Drain-Source Voltage (0 - 1000V)

Typical Performance

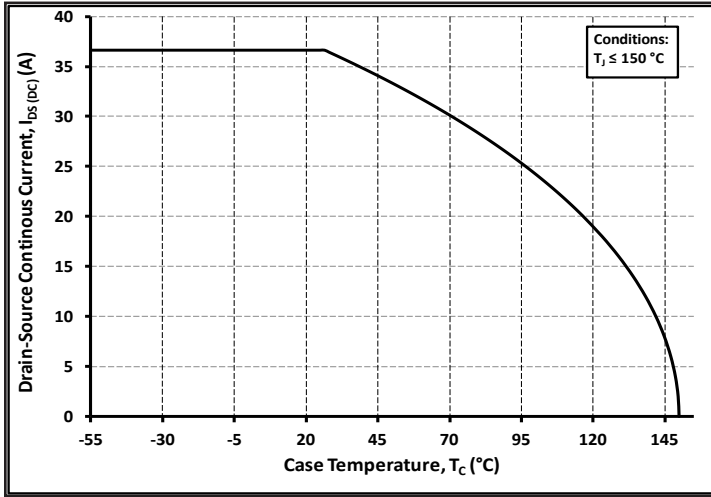

Figure 19. Continuous Drain Current Derating vs. Case Temperature

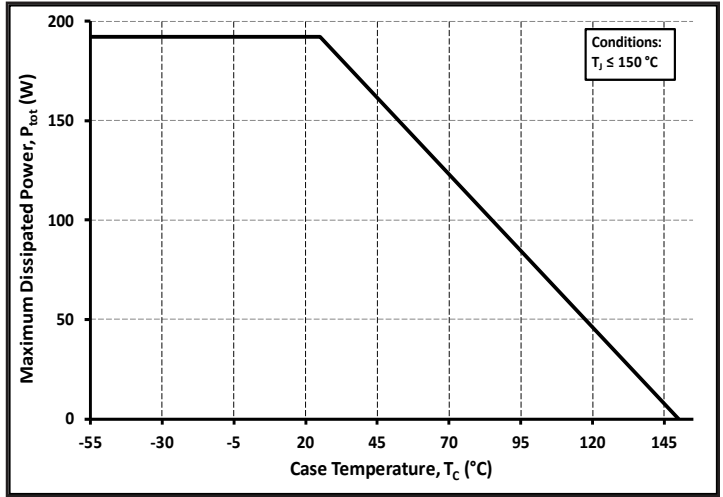

Figure 20. Maximum Power Dissipation Derating vs. Case Temperature

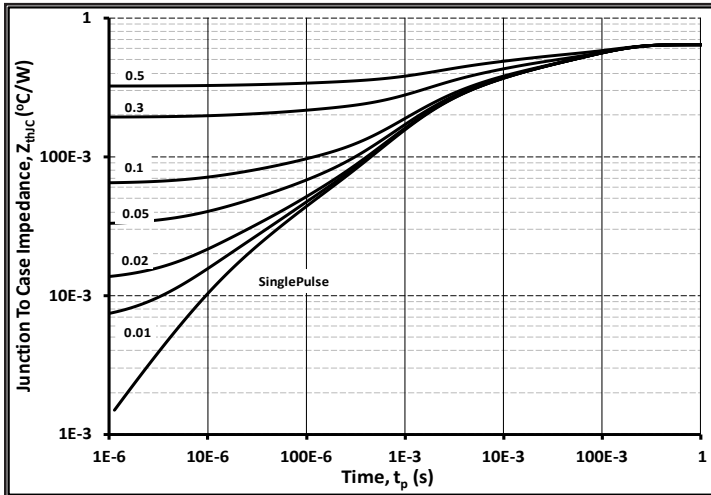

Figure 21. Transient Thermal Impedance (Junction - Case)

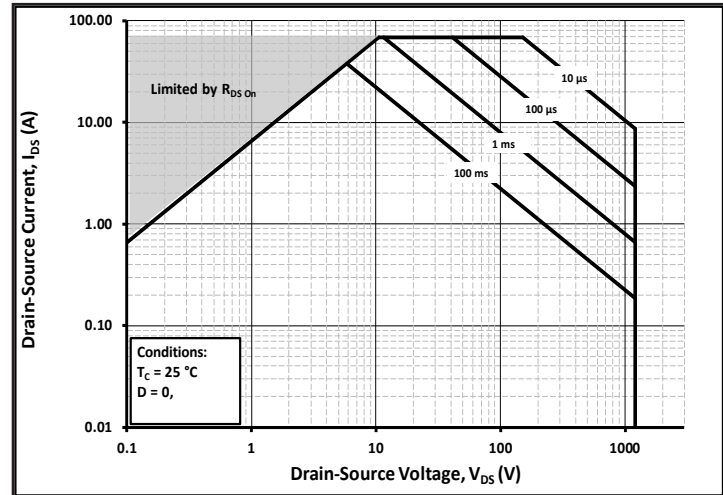

Figure 22. Safe Operating Area

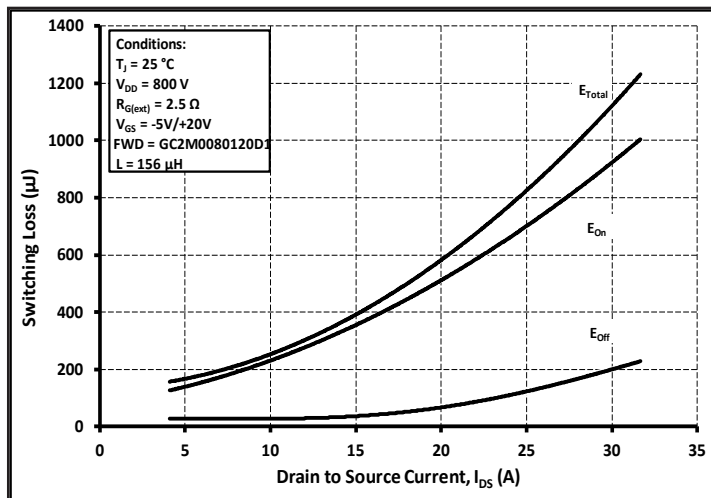

Figure 23. Clamped Inductive Switching Energy vs. Drain Current ( $V_{DD} = 800V$ )

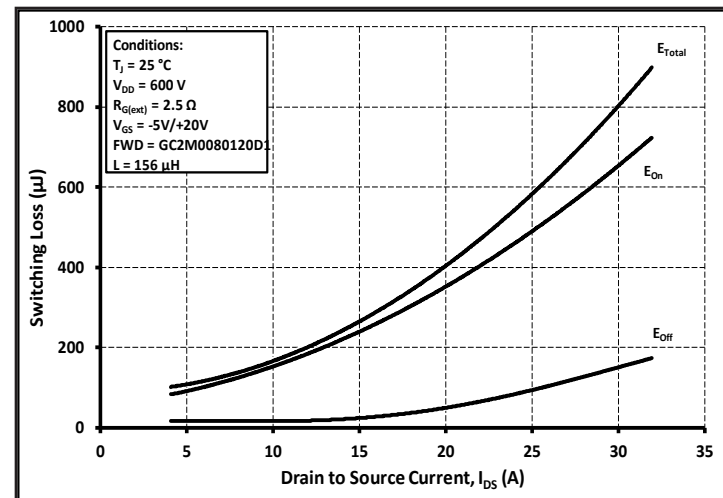

Figure 24. Clamped Inductive Switching Energy vs. Drain Current ( $V_{DD} = 600V$ )

Typical Performance

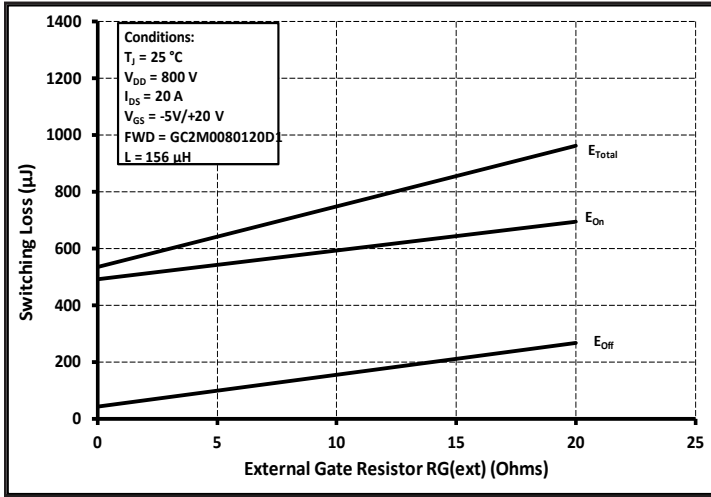

Figure 25. Clamped Inductive Switching Energy vs.  $R_{G(ext)}$

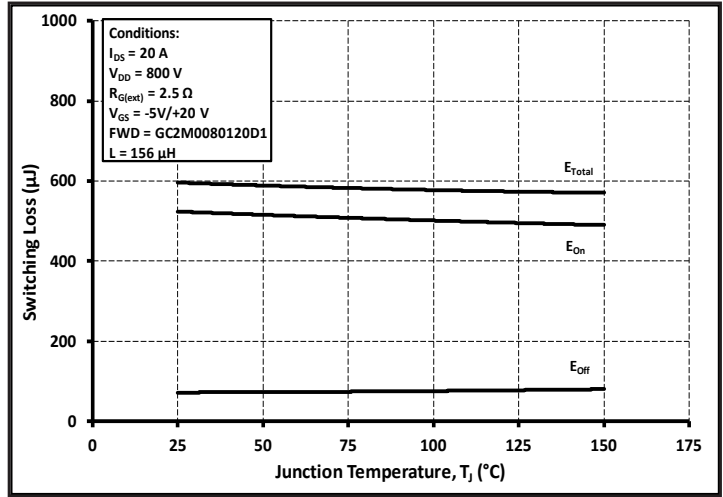

Figure 26. Clamped Inductive Switching Energy vs. Temperature

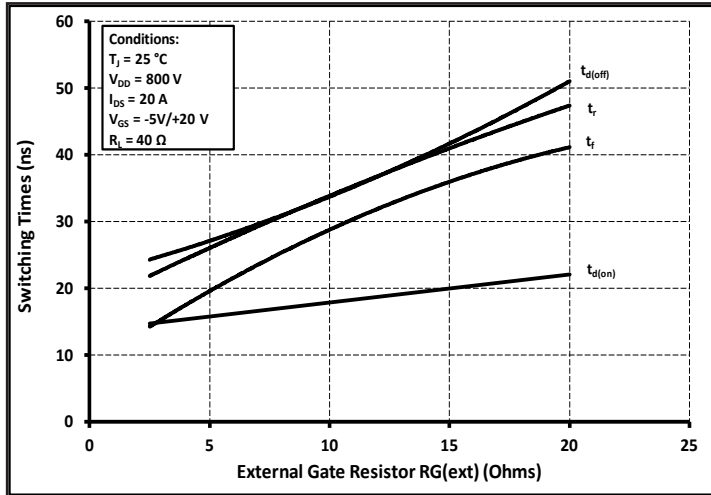

Figure 27. Switching Times vs.  $R_{G(ext)}$

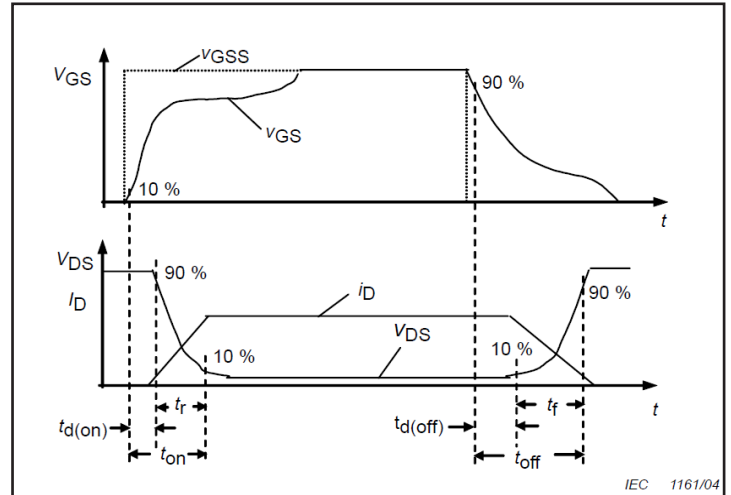

Figure 28. Switching Times Definition

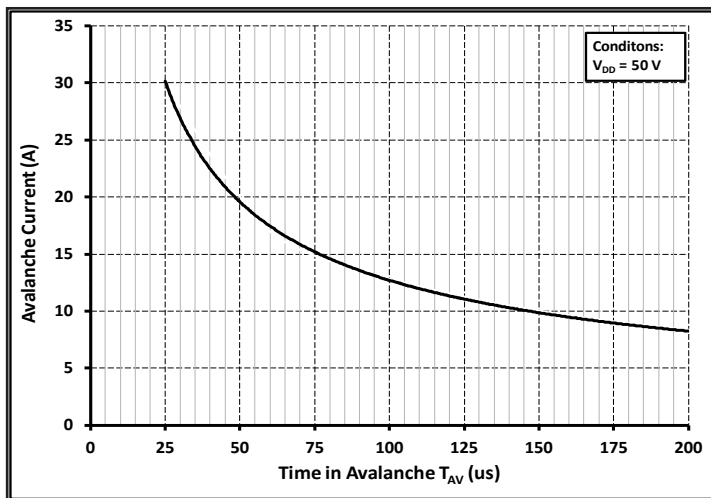

Figure 29. Single Avalanche SOA curve



**Test Circuit Schematic**

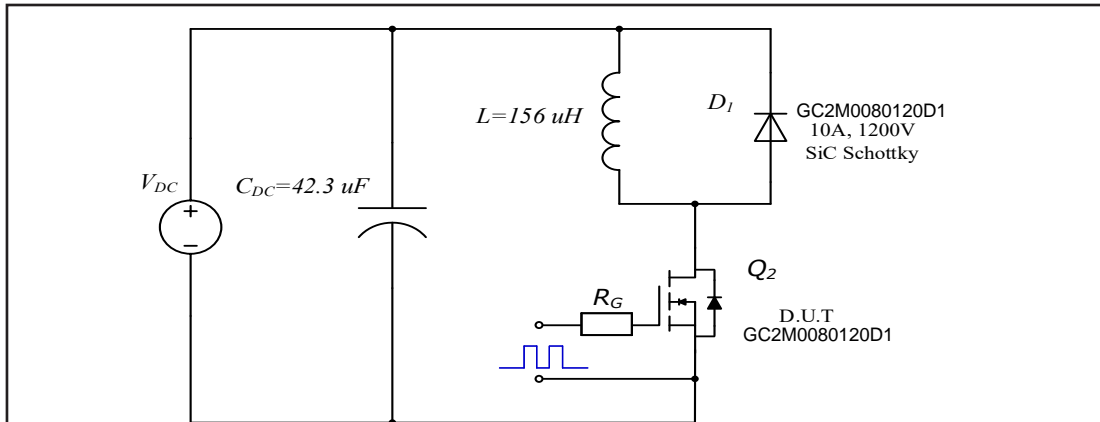

Figure 30. Clamped Inductive Switching Waveform Test Circuit

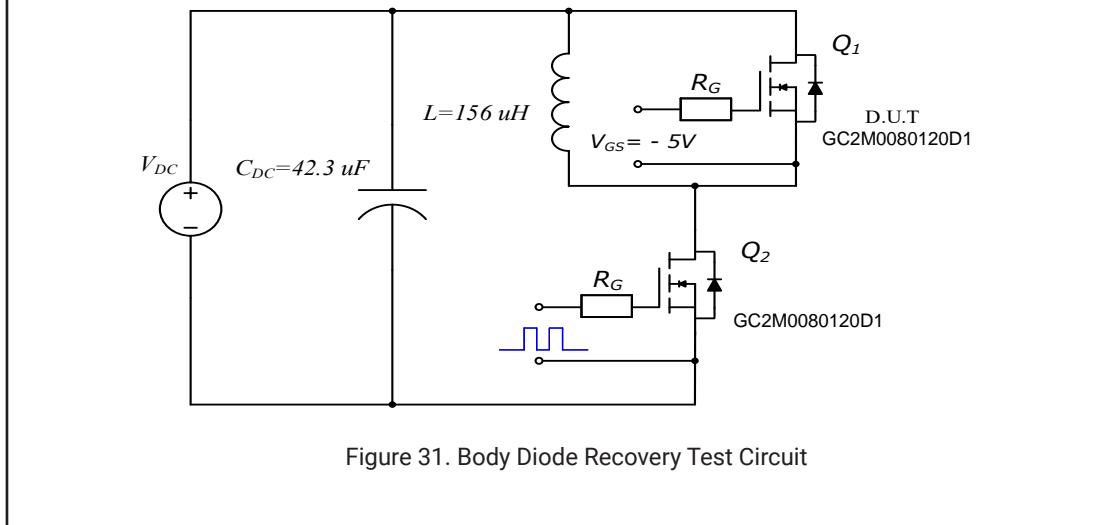

Figure 31. Body Diode Recovery Test Circuit

**ESD Ratings**

ESD Test	Total Devices Sampled	Resulting Classification
ESD-HBM	All Devices Passed 1000V	2 (>2000V)
ESD-MM	All Devices Passed 400V	C (>400V)
ESD-CDM	All Devices Passed 1000V	IV (>1000V)



### Package Dimensions

Package TO-247-3

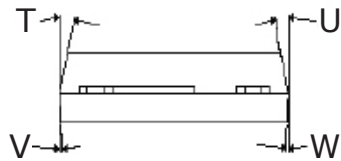
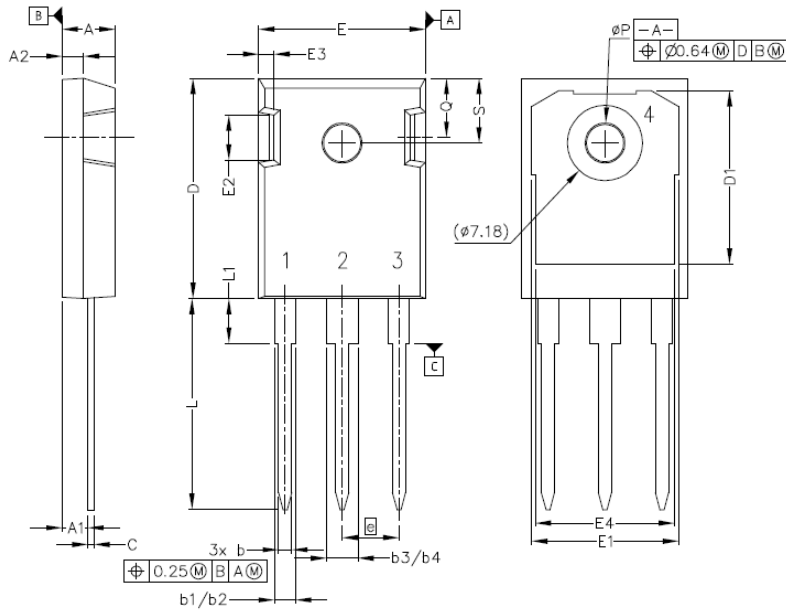

Pinout Information:

- Pin 1 = Gate
- Pin 2, 4 = Drain
- Pin 3 = Source

POS	Inches		Millimeters	
	Min	Max	Min	Max
A	.190	.205	4.83	5.21
A1	.090	.100	2.29	2.54
A2	.075	.085	1.91	2.16
b	.042	.052	1.07	1.33
b1	.075	.095	1.91	2.41
b2	.075	.085	1.91	2.16
b3	.113	.133	2.87	3.38
b4	.113	.123	2.87	3.13
c	.022	.027	0.55	0.68
D	.819	.831	20.80	21.10
D1	.640	.695	16.25	17.65
D2	.037	.049	0.95	1.25
E	.620	.635	15.75	16.13
E1	.516	.557	13.10	14.15
E2	.145	.201	3.68	5.10
E3	.039	.075	1.00	1.90
E4	.487	.529	12.38	13.43
e	.214 BSC		5.44 BSC	
N	3		3	
L	.780	.800	19.81	20.32
L1	.161	.173	4.10	4.40
ØP	.138	.144	3.51	3.65
Q	.216	.236	5.49	6.00
S	.238	.248	6.04	6.30
T	9°	11°	9°	11°
U	9°	11°	9°	11°
V	2°	8°	2°	8°
W	2°	8°	2°	8°

### Recommended Solder Pad Layout

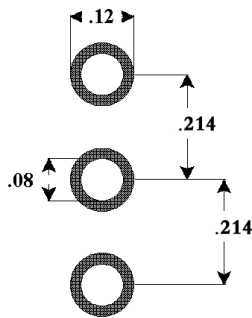

TO-247-3

Part Number	Package
GC2M0080120D1	TO-247-3