

P-Channel Enhancement Mode Power MOSFET

Description

The GT1K2P15K uses advanced trench technology to provide excellent $R_{DS(ON)}$, low gate charge. It can be used in a wide variety of applications.

General Features

- V_{DS} -150V
- I_D (at $V_{GS} = -10V$) -27A
- $R_{DS(ON)}$ (at $V_{GS} = -10V$) < 110m Ω
- $R_{DS(ON)}$ (at $V_{GS} = -4.5V$) < 130m Ω
- 100% Avalanche Tested
- RoHS Compliant

Application

- Power switch
- DC/DC converters

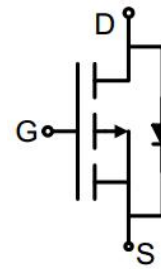

Schematic diagram

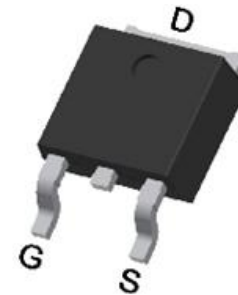

TO-252

Ordering Information

Device	Package	Marking	Packaging
GT1K2P15K	TO-252	GT1K2P15	2500pcs/Reel

Absolute Maximum Ratings $T_C = 25^\circ\text{C}$, unless otherwise noted

Parameter	Symbol	Value	Unit
Drain-Source Voltage	V_{DS}	-150	V
Continuous Drain Current	I_D	-27	A
Pulsed Drain Current (note1)	I_{DM}	-108	A
Gate-Source Voltage	V_{GS}	± 20	V
Power Dissipation	P_D	138	W
Single pulse avalanche energy (note2)	E_{AS}	156	mJ
Operating Junction and Storage Temperature Range	T_J, T_{stg}	-55 To 150	$^\circ\text{C}$

Thermal Resistance

Parameter	Symbol	Value	Unit
Thermal Resistance, Junction-to-Ambient	R_{thJA}	50	$^\circ\text{C/W}$
Maximum Junction-to-Case	R_{thJC}	0.9	$^\circ\text{C/W}$

Specifications $T_J = 25^\circ\text{C}$, unless otherwise noted						
Parameter	Symbol	Test Conditions	Value			Unit
			Min.	Typ.	Max.	
Static Parameters						
Drain-Source Breakdown Voltage	$V_{(BR)DSS}$	$V_{GS} = 0V, I_D = -250\mu A$	-150	--	--	V
Zero Gate Voltage Drain Current	I_{DSS}	$V_{DS} = -150V, V_{GS} = 0V$	--	--	-1	μA
Gate-Source Leakage	I_{GSS}	$V_{GS} = \pm 20V$	--	--	± 100	nA
Gate-Source Threshold Voltage	$V_{GS(th)}$	$V_{DS} = V_{GS}, I_D = -250\mu A$	-1.0	-2.0	-3.0	V
Drain-Source On-Resistance	$R_{DS(on)}$	$V_{GS} = -10V, I_D = -15A$	--	90	110	m Ω
		$V_{GS} = -4.5V, I_D = -15A$	--	100	130	
Forward Transconductance	g_{FS}	$V_{DS} = -5V, I_D = -15A$	--	31	--	S
Dynamic Parameters						
Input Capacitance	C_{iss}	$V_{GS} = 0V,$ $V_{DS} = -75V,$ $f = 0.8MHz$	--	3275	--	pF
Output Capacitance	C_{oss}		--	136	--	
Reverse Transfer Capacitance	C_{rss}		--	10	--	
Total Gate Charge	Q_g	$V_{DD} = -75V,$ $I_D = -15A,$ $V_{GS} = -10V$	--	86	--	nC
Gate-Source Charge	Q_{gs}		--	9	--	
Gate-Drain Charge	Q_{gd}		--	19	--	
Turn-on Delay Time	$t_{d(on)}$	$V_{DD} = -75V,$ $I_D = -15A,$ $R_G = 1.6\Omega$	--	62	--	ns
Turn-on Rise Time	t_r		--	17	--	
Turn-off Delay Time	$t_{d(off)}$		--	68	--	
Turn-off Fall Time	t_f		--	29	--	
Drain-Source Body Diode Characteristics						
Continuous Body Diode Current	I_S	$T_C = 25^\circ\text{C}$	--	--	-27	A
Body Diode Voltage	V_{SD}	$T_J = 25^\circ\text{C}, I_{SD} = -15A, V_{GS} = 0V$	--	--	-1.2	V
Reverse Recovery Charge	Q_{rr}	$I_F = -15A, V_{GS} = 0V$ $di/dt = -100A/\mu s$	--	362	--	nC
Reverse Recovery Time	T_{rr}		--	88	--	ns

Notes

1. Repetitive Rating: Pulse width limited by maximum junction temperature
2. EAS condition : $T_J = 25^\circ\text{C}, V_{DD} = -50V, V_{GS} = -10V, L = 0.5mH, R_G = 25\Omega$
The table shows the minimum avalanche energy, which is 420mJ when the device is tested until failure
3. Identical low side and high side switch with identical R_G

Gate Charge Test Circuit

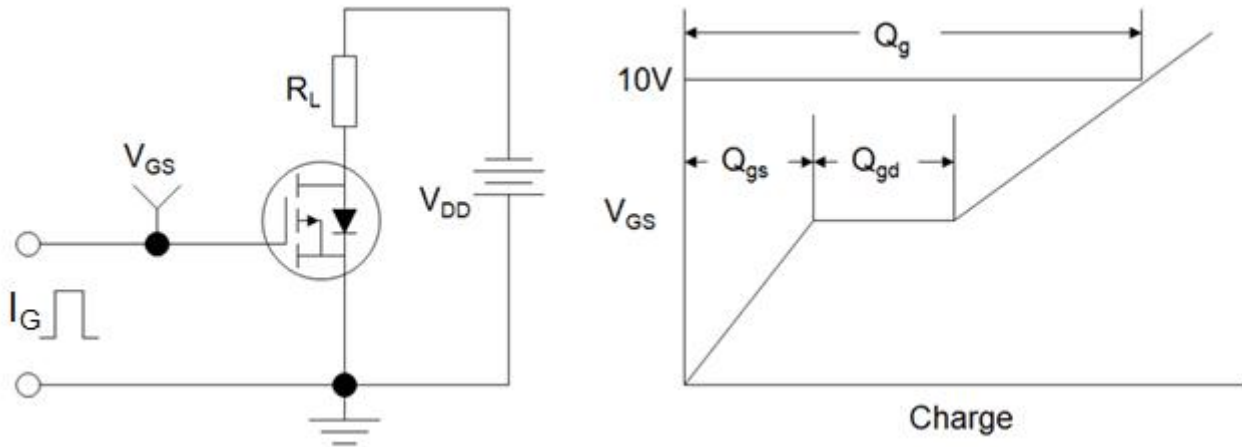

Switch Time Test Circuit

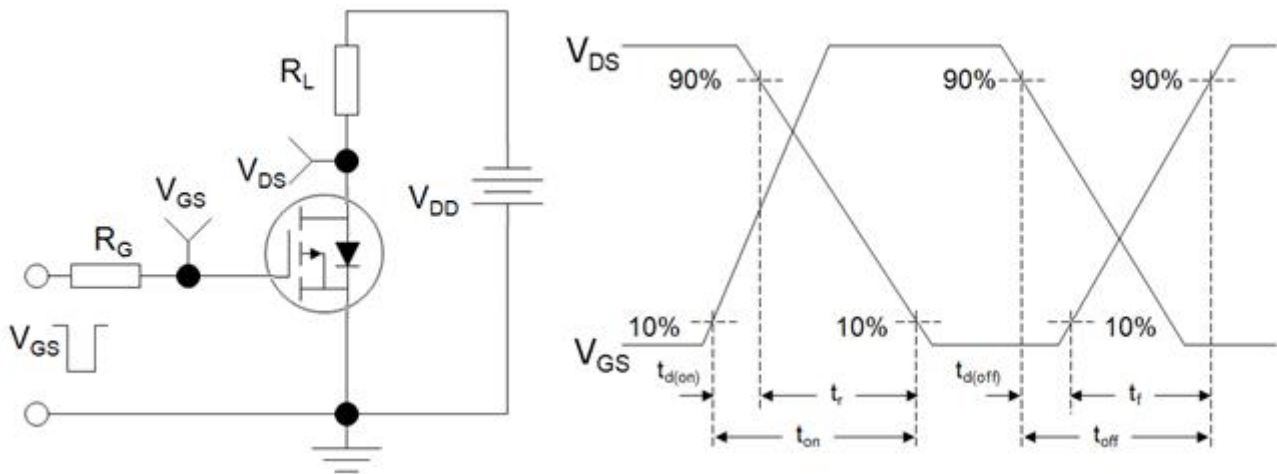

EAS Test Circuit

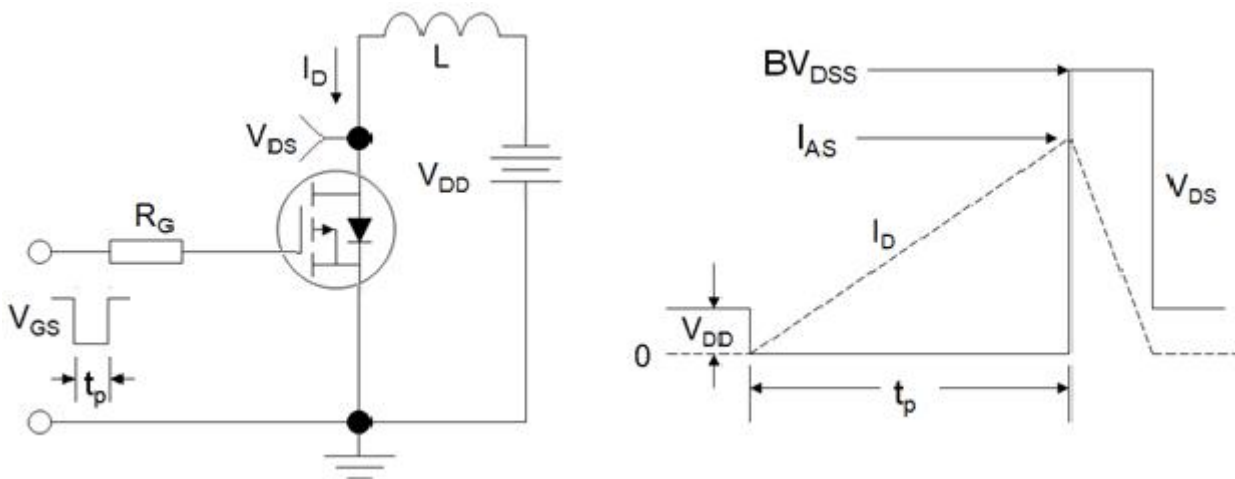

Typical Characteristics $T_J = 25^\circ\text{C}$, unless otherwise noted

Figure 1. Output Characteristics

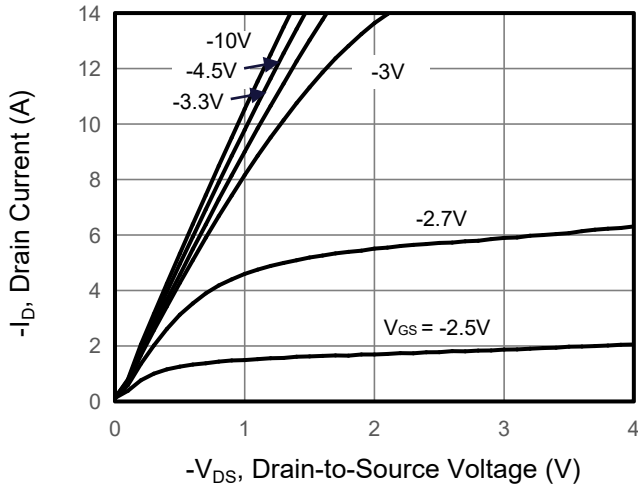

Figure 2. Transfer Characteristics

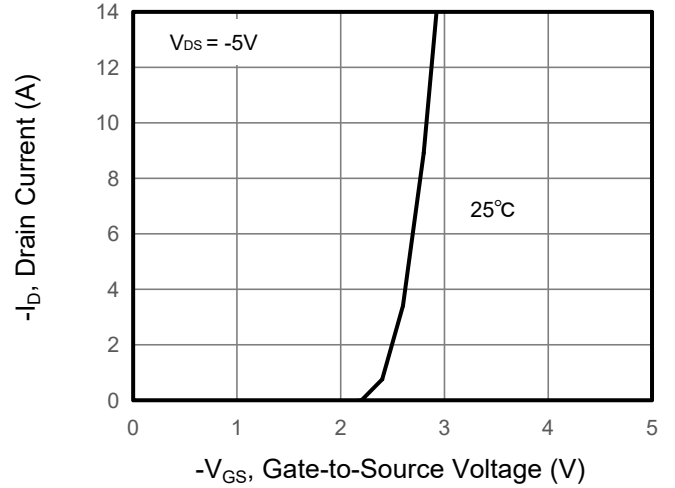

Figure 3. Drain Source On Resistance

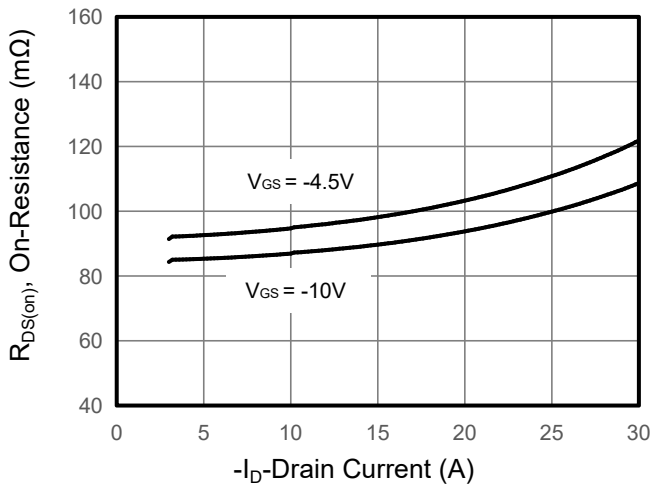

Figure 4. Gate Charge

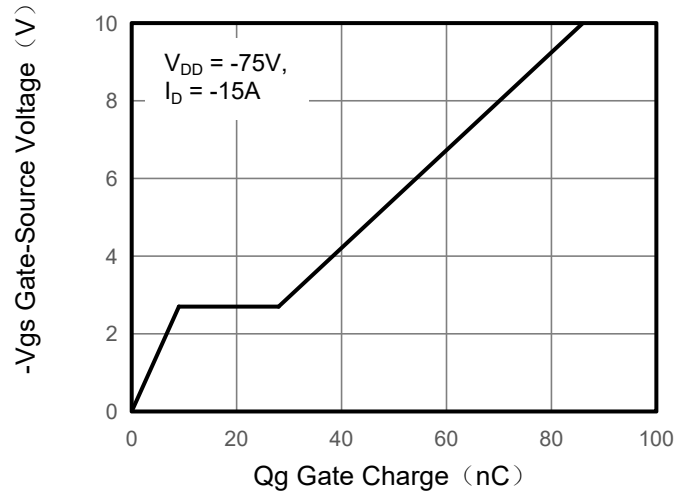

Figure 5. Capacitance

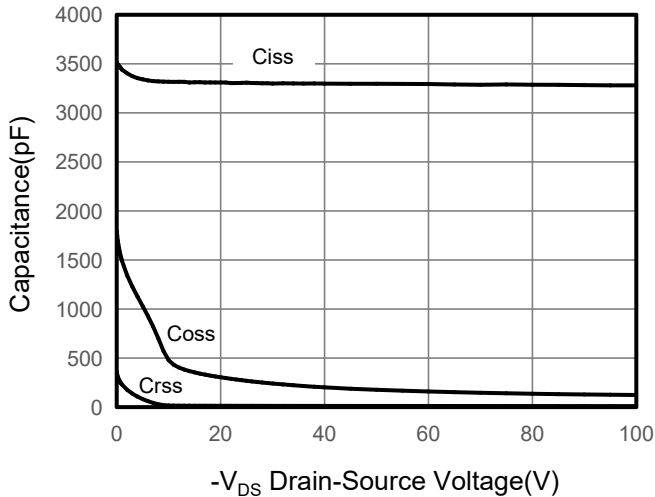
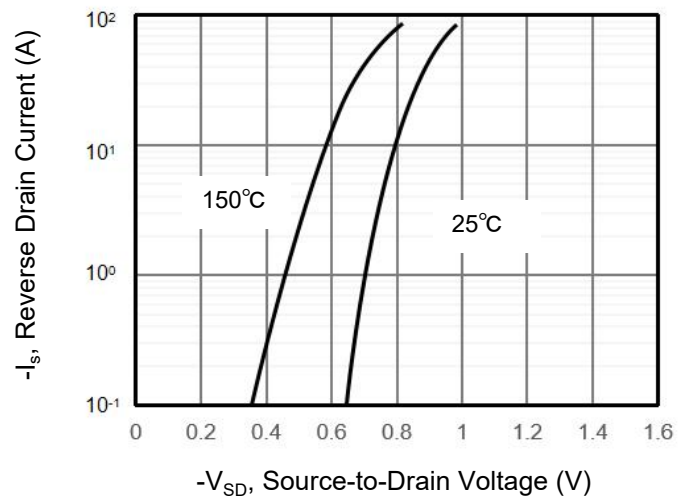

Figure 6. Source-Drain Diode Forward



Typical Characteristics $T_J = 25^\circ\text{C}$, unless otherwise noted

Figure 7. Drain-Source On-Resistance

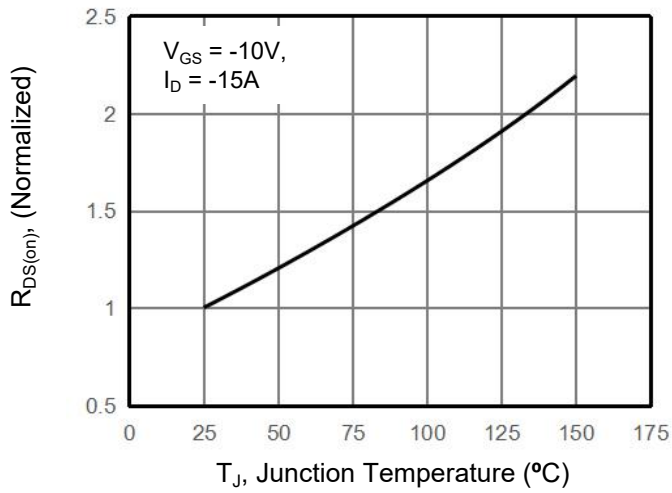

Figure 10. Safe Operation Area

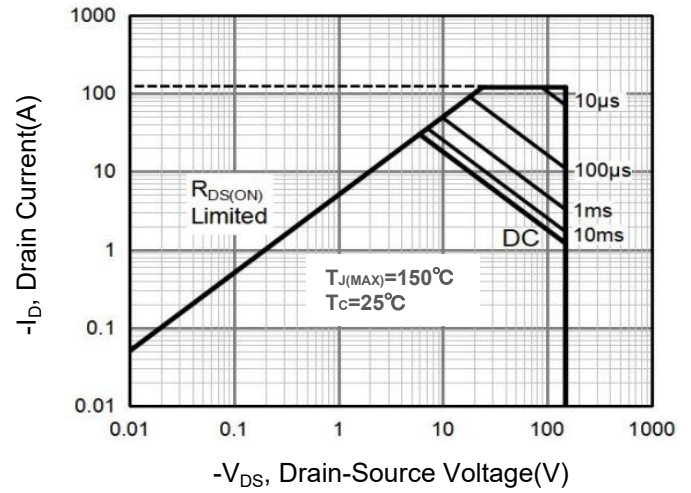
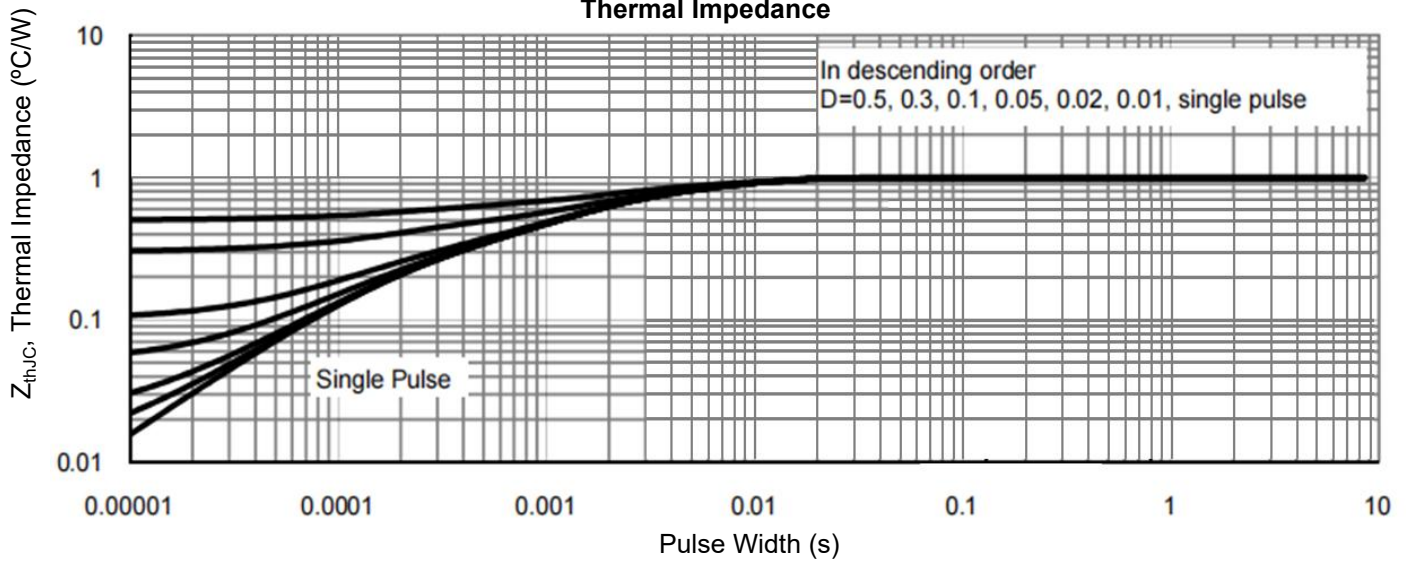
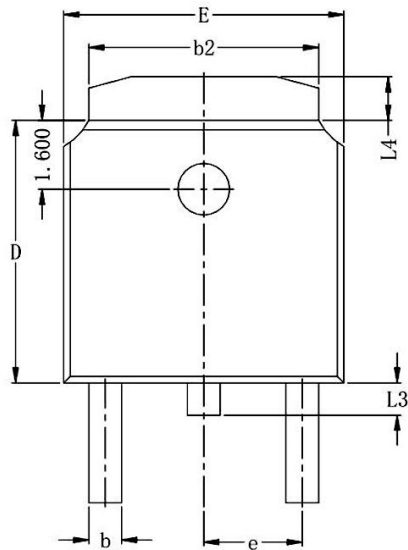

Figure 9. Normalized Maximum Transient Thermal Impedance



TO-252 Package Information



TOP VIEW

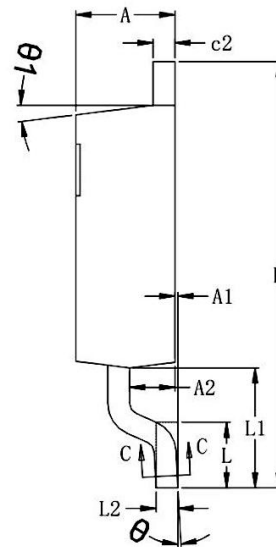

SIDE VIEW (Right)

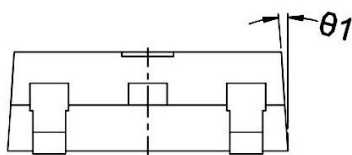

SIDE VIEW (Front)

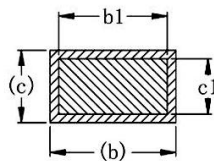

SECTION: C-C

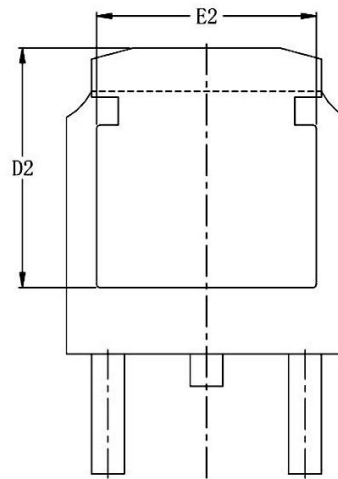

OPTION 1
BOTTOM VIEW

DIM SYMBOL	MIN.	NOM.	MAX.	DIM SYMBOL	MIN.	NOM.	MAX.
A	2.200	2.300	2.400	E	6.400	6.500	6.600
A1	0.000	0.070	0.130	E2	4.900	5.100	5.300
A2	0.950	1.050	1.150	e	2.286 BSC.		
b	0.700	0.800	0.900	H	9.700	9.900	10.100
b1	0.660	0.760	0.860	L	1.380	1.525	1.725
b2	5.134	5.334	5.534	L1	2.588	2.788	2.988
c	0.448	0.548	0.648	L2	0.508 BSC.		
c1	0.458	0.508	0.558	L3	0.600	0.750	0.950
c2	0.448	0.548	0.648	L4	0.812	1.012	1.212
D	6.000	6.100	6.200	θ	1°	3°	5°
D2	5.372	5.572	5.772	θ_1	6°	7°	8°