

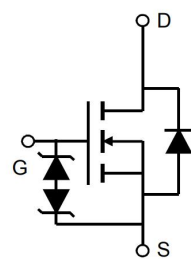

N-Channel Enhancement Mode Power MOSFET

<p>Description</p> <p>The GT011N03TE uses advanced trench technology to provide excellent $R_{DS(ON)}$, low gate charge. It can be used in a wide variety of applications.</p> <p>General Features</p> <ul style="list-style-type: none"> ● V_{DS} 30V ● I_D (at $V_{GS} = 10V$) 209A ● $R_{DS(ON)}$ (at $V_{GS} = 10V$) < 2.2mΩ ● $R_{DS(ON)}$ (at $V_{GS} = 4.5V$) < 3.0mΩ ● 100% Avalanche Tested ● RoHS Compliant ● ESD (HBM) : 7KV <p>Application</p> <ul style="list-style-type: none"> ● Power switch ● DC/DC converters 	 <p>Schematic diagram</p>  <p>TO-220</p>
---	--

Ordering Information

Device	Package	Marking	Packaging
GT011N03TE	TO-220	GT011N03	50pcs/Tube

Absolute Maximum Ratings $T_C = 25^\circ C$, unless otherwise noted

Parameter	Symbol	Value	Unit
Drain-Source Voltage	V_{DS}	30	V
Continuous Drain Current	I_D	209	A
Pulsed Drain Current (note1)	I_{DM}	836	A
Gate-Source Voltage	V_{GS}	± 20	V
Power Dissipation	P_D	89	W
Single pulse avalanche energy (note2)	E_{AS}	361	mJ
Operating Junction and Storage Temperature Range	T_J, T_{stg}	-55 To 175	$^\circ C$

Thermal Resistance

Parameter	Symbol	Value	Unit
Thermal Resistance, Junction-to-Ambient	R_{thJA}	55	$^\circ C/W$
Maximum Junction-to-Case	R_{thJC}	1.4	$^\circ C/W$

Specifications $T_J = 25^\circ\text{C}$, unless otherwise noted						
Parameter	Symbol	Test Conditions	Value			Unit
			Min.	Typ.	Max.	
Static Parameters						
Drain-Source Breakdown Voltage	$V_{(BR)DSS}$	$V_{GS} = 0V, I_D = 250\mu A$	30	--	--	V
Zero Gate Voltage Drain Current	I_{DSS}	$V_{DS} = 30V, V_{GS} = 0V$	--	--	1	μA
Gate-Source Leakage	I_{GSS}	$V_{GS} = \pm 20V$	--	--	± 50	μA
Gate-Source Threshold Voltage	$V_{GS(th)}$	$V_{DS} = V_{GS}, I_D = 250\mu A$	1.0	1.7	2.5	V
Drain-Source On-Resistance	$R_{DS(on)}$	$V_{GS} = 10V, I_D = 30A$	--	1.8	2.2	m Ω
		$V_{GS} = 4.5V, I_D = 30A$	--	2.4	3.0	
Forward Transconductance	g_{FS}	$V_{GS} = 5V, I_D = 30A$	--	74	--	S
Dynamic Parameters						
Input Capacitance	C_{iss}	$V_{GS} = 0V,$ $V_{DS} = 15V,$ $f = 0.6MHz$	--	5988	--	pF
Output Capacitance	C_{oss}		--	2070	--	
Reverse Transfer Capacitance	C_{rss}		--	63	--	
Total Gate Charge	Q_g	$V_{DD} = 15V,$ $I_D = 30A,$ $V_{GS} = 10V$	--	98	--	nC
Gate-Source Charge	Q_{gs}		--	16	--	
Gate-Drain Charge	Q_{gd}		--	11	--	
Turn-on Delay Time	$t_{d(on)}$	$V_{DD} = 15V,$ $I_D = 30A,$ $R_G = 1.6\Omega$	--	13	--	ns
Turn-on Rise Time	t_r		--	7.5	--	
Turn-off Delay Time	$t_{d(off)}$		--	51	--	
Turn-off Fall Time	t_f		--	8.6	--	
Drain-Source Body Diode Characteristics						
Continuous Body Diode Current	I_S	$T_C = 25^\circ\text{C}$	--	--	209	A
Body Diode Voltage	V_{SD}	$T_J = 25^\circ\text{C}, I_{SD} = 30A, V_{GS} = 0V$	--	--	1.2	V
Reverse Recovery Charge	Q_{rr}	$I_F = 30A, V_{GS} = 0V$ $di/dt=100A/us$	--	112	--	nC
Reverse Recovery Time	T_{rr}		--	32	--	ns

Notes

1. Repetitive Rating: Pulse width limited by maximum junction temperature
2. EAS condition : $T_J=25^\circ\text{C}$, $V_{DD}=30V, V_{GS}=10V, L=0.5mH, R_G=25\Omega$
3. Identical low side and high side switch with identical R_G

Gate Charge Test Circuit



Switch Time Test Circuit

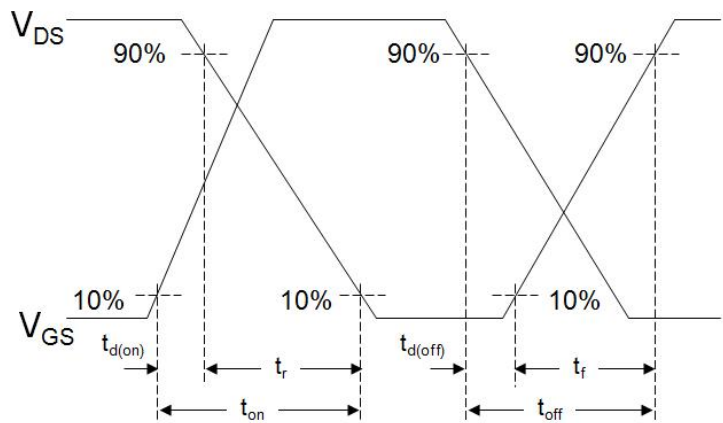
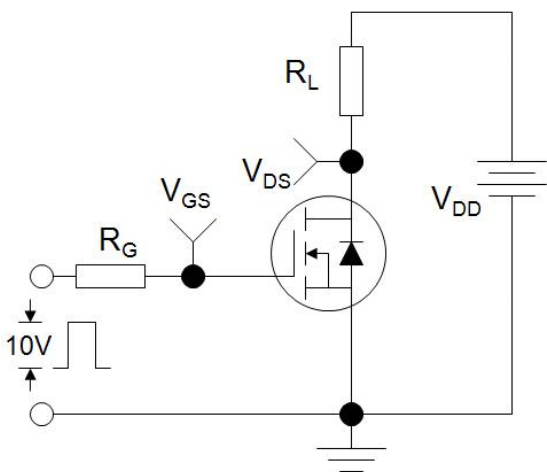

EAS Test Circuit



Typical Characteristics $T_J = 25^\circ\text{C}$, unless otherwise noted

Figure 1. Output Characteristics

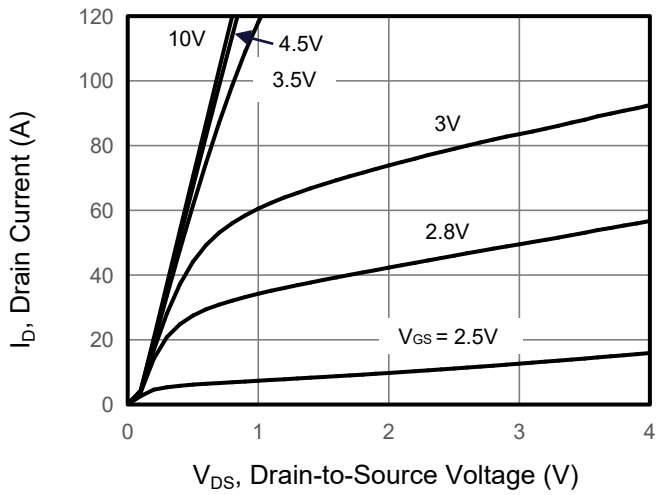

Figure 2. Transfer Characteristics

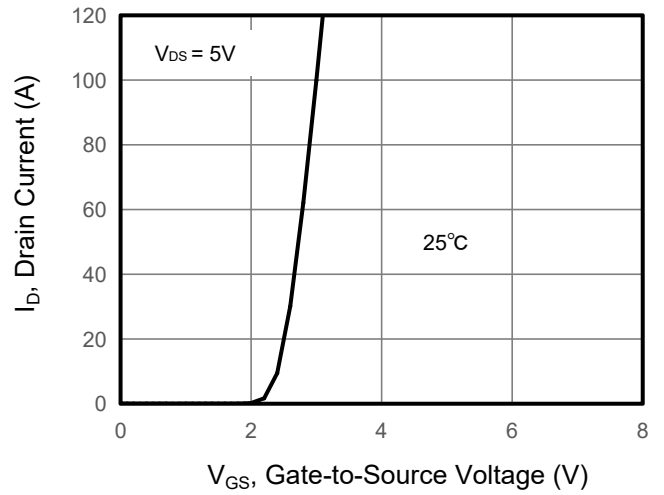

Figure 3. Drain Source On Resistance

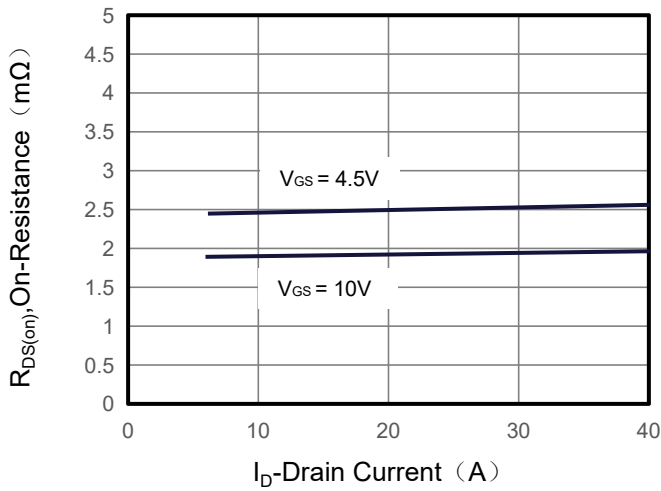

Figure 4. Gate Charge

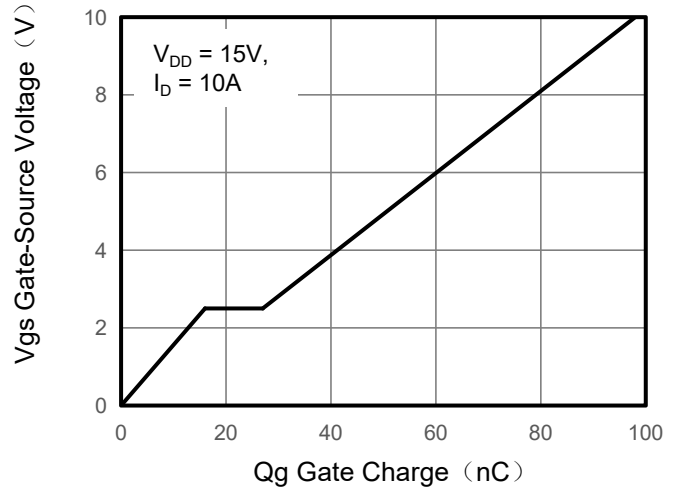

Figure 5. Capacitance

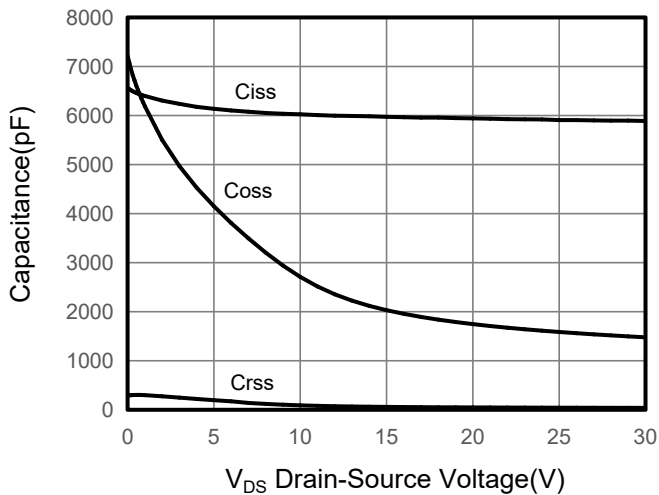
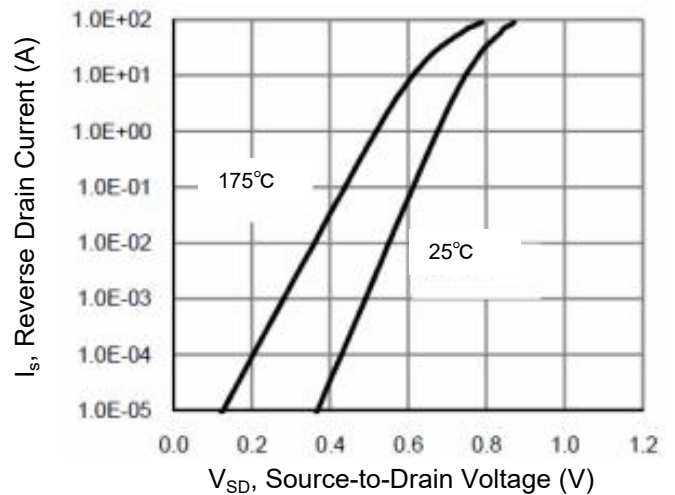

Figure 6. Source-Drain Diode Forward



Typical Characteristics $T_J = 25^\circ\text{C}$, unless otherwise noted

Figure 7. Drain-Source On-Resistance

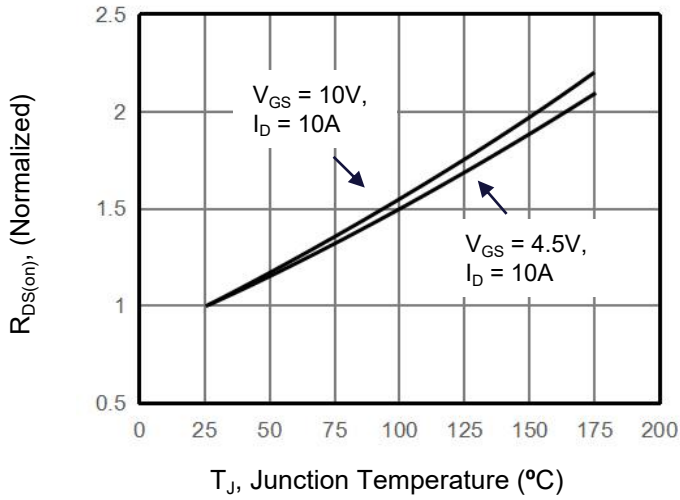

Figure 8. Safe Operation Area

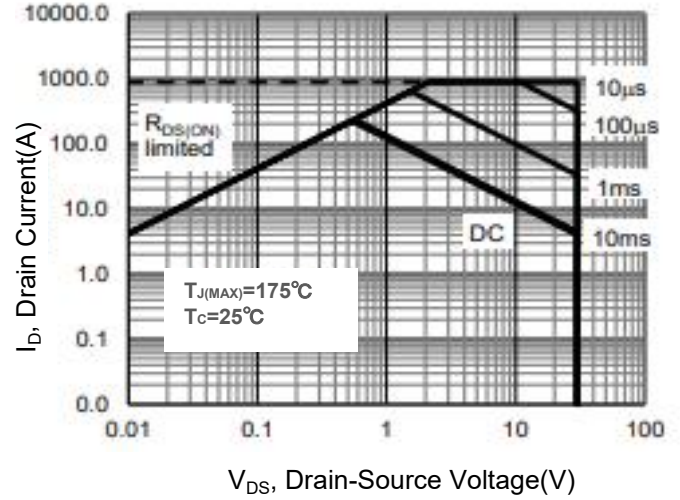
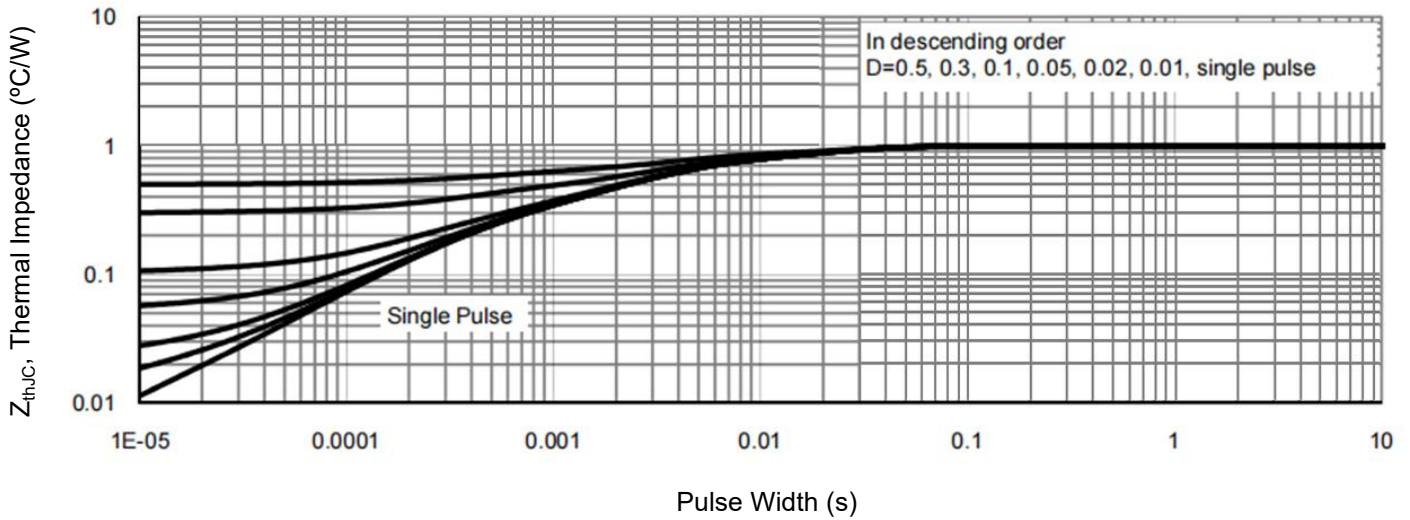

Figure 9. Normalized Maximum Transient Thermal Impedance



TO-220 Package Information



COMMON DIMENSIONS

SYMBOL	mm		
	MIN	NOM	MAX
A	4.37	4.57	4.77
A1	1.22	1.27	1.42
A2	2.49	2.69	2.89
b	0.75	0.81	0.96
b2	1.22	1.27	1.47
c	0.30	0.38	0.48
D1	8.50	8.70	8.90
D2	5.20	-	-
E	9.86	10.16	10.36
E5	7.06	-	-
e	2.54BSC		
e1	5.08BSC		
H1	6.10	6.30	6.50
L	13.10	13.40	13.70
L1	-	3.75	4.10
ΦP	3.70	3.84	3.99
Q	2.54	2.74	2.94