

N-Channel Enhancement Mode Power MOSFET

Description

The GC180N65MF uses advanced trench technology to provide excellent $R_{DS(ON)}$, low gate charge. It can be used in a wide variety of applications.

General Features

- V_{DS} 650V
- I_D (at $V_{GS} = 10V$) 20A
- $R_{DS(ON)}$ (at $V_{GS} = 10V$) < 190m Ω
- 100% Avalanche Tested
- RoHS Compliant
- Ultra-fast body diode

Application

- Power switch
- DC/DC converters

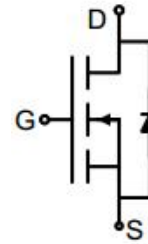

Schematic diagram

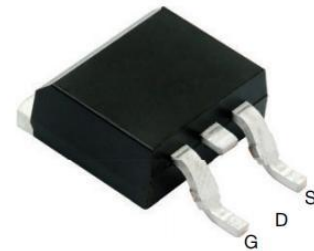

TO-263

Ordering Information

Device	Package	Marking	Packaging
GC180N65MF	TO-263	GC180N65	800pcs/Reel

Absolute Maximum Ratings $T_C = 25^\circ C$, unless otherwise noted

Parameter	Symbol	Value	Unit
Drain-Source Voltage	V_{DS}	650	V
Continuous Drain Current	I_D	20	A
Pulsed Drain Current (note1)	I_{DM}	60	A
Gate-Source Voltage	V_{GS}	± 30	V
Power Dissipation	P_D	151	W
Single pulse avalanche energy (note2)	E_{AS}	245	mJ
Operating Junction and Storage Temperature Range	T_J, T_{stg}	-55 To 150	$^\circ C$

Thermal Resistance

Parameter	Symbol	Value	Unit
Thermal Resistance, Junction-to-Ambient	R_{thJA}	62	$^\circ C/W$
Maximum Junction-to-Case	R_{thJC}	0.83	$^\circ C/W$

Specifications $T_J = 25^\circ\text{C}$, unless otherwise noted						
Parameter	Symbol	Test Conditions	Value			Unit
			Min.	Typ.	Max.	
Static Parameters						
Drain-Source Breakdown Voltage	$V_{(BR)DSS}$	$V_{GS} = 0V, I_D = 250\mu A$	650	--	--	V
Zero Gate Voltage Drain Current	I_{DSS}	$V_{DS} = 650V, V_{GS} = 0V$	--	--	10	μA
Gate-Source Leakage	I_{GSS}	$V_{GS} = \pm 30V$	--	--	± 100	nA
Gate-Source Threshold Voltage	$V_{GS(th)}$	$V_{DS} = V_{GS}, I_D = 250\mu A$	3.0	4.0	5.0	V
Drain-Source On-Resistance	$R_{DS(on)}$	$V_{GS} = 10V, I_D = 10A$	--	155	190	m Ω
Forward Transconductance	g_{FS}	$V_{GS} = 5V, I_D = 10A$	--	16	--	S
Dynamic Parameters						
Input Capacitance	C_{iss}	$V_{GS} = 0V,$ $V_{DS} = 100V,$ $f = 1.0\text{MHz}$	--	1728	--	pF
Output Capacitance	C_{oss}		--	39	--	
Reverse Transfer Capacitance	C_{rss}		--	3	--	
Total Gate Charge	Q_g	$V_{DD} = 480V,$ $I_D = 10A,$ $V_{GS} = 10V$	--	39	--	nC
Gate-Source Charge	Q_{gs}		--	9	--	
Gate-Drain Charge	Q_{gd}		--	16	--	
Turn-on Delay Time	$t_{d(on)}$	$V_{DD} = 400V,$ $I_D = 10A,$ $R_G = 25\Omega$	--	77	--	ns
Turn-on Rise Time	t_r		--	36	--	
Turn-off Delay Time	$t_{d(off)}$		--	120	--	
Turn-off Fall Time	t_f		--	63	--	
Drain-Source Body Diode Characteristics						
Continuous Body Diode Current	I_S	$T_C = 25^\circ\text{C}$	--	--	20	A
Body Diode Voltage	V_{SD}	$T_J = 25^\circ\text{C}, I_{SD} = 10A, V_{GS} = 0V$	--	--	1.2	V
Reverse Recovery Charge	Q_{rr}	$I_F = 10A, V_{GS} = 0V$ $di/dt = 100A/\mu s$	--	431	--	nC
Reverse Recovery Time	T_{rr}		--	109	--	ns

Notes

1. Repetitive Rating: Pulse width limited by maximum junction temperature
2. EAS condition : $T_J = 25^\circ\text{C}, V_{DD} = 50V, V_{GS} = 10V, L = 10\text{mH}, R_G = 25\Omega$
3. Identical low side and high side switch with identical R_G

Gate Charge Test Circuit

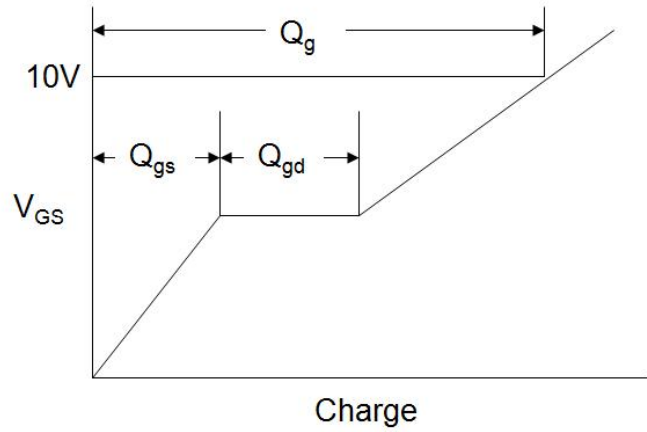
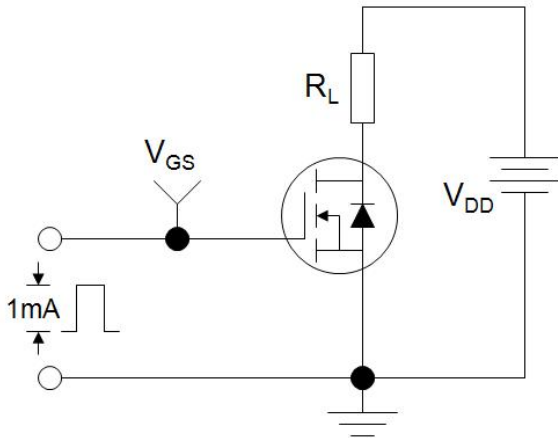

Switch Time Test Circuit



EAS Test Circuit



Typical Characteristics $T_J = 25^\circ\text{C}$, unless otherwise noted

Figure 1. Output Characteristics

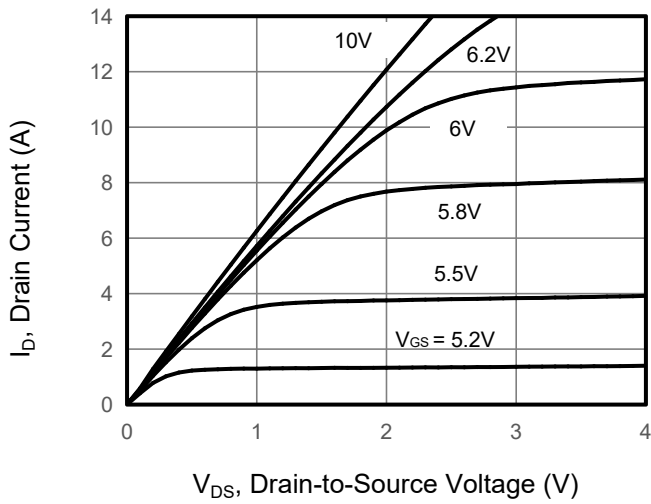

Figure 2. Transfer Characteristics

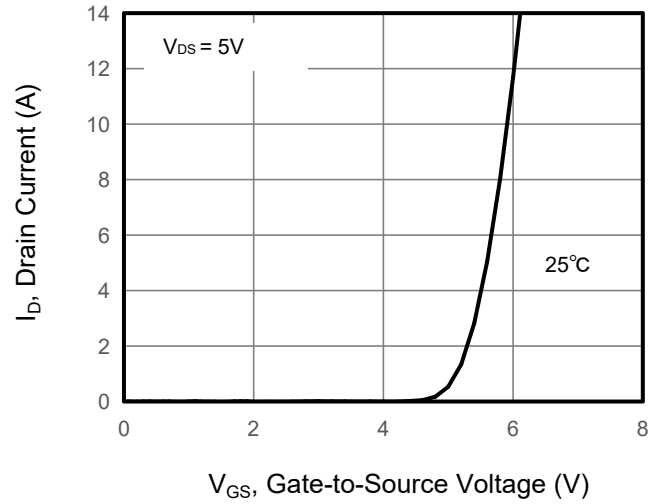

Figure 3. Drain Source On Resistance

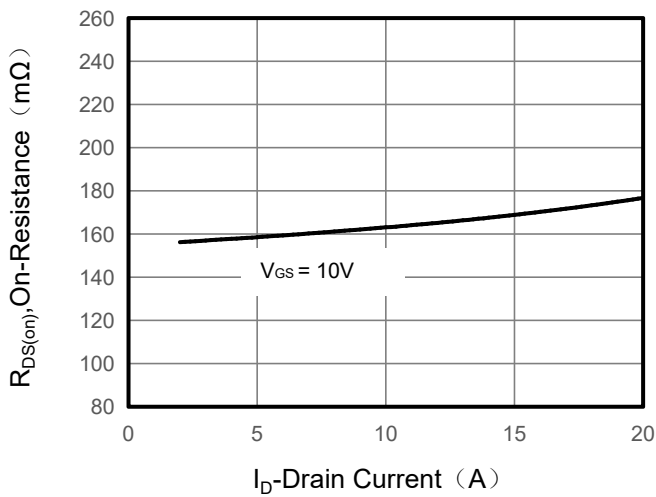

Figure 4. Gate Charge

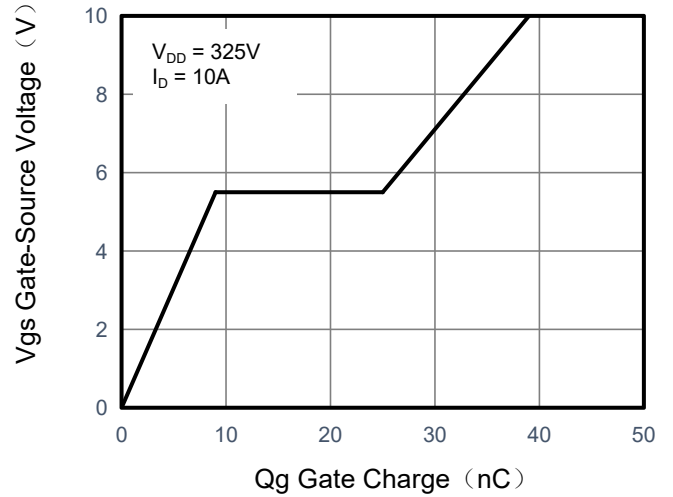

Figure 5. Capacitance

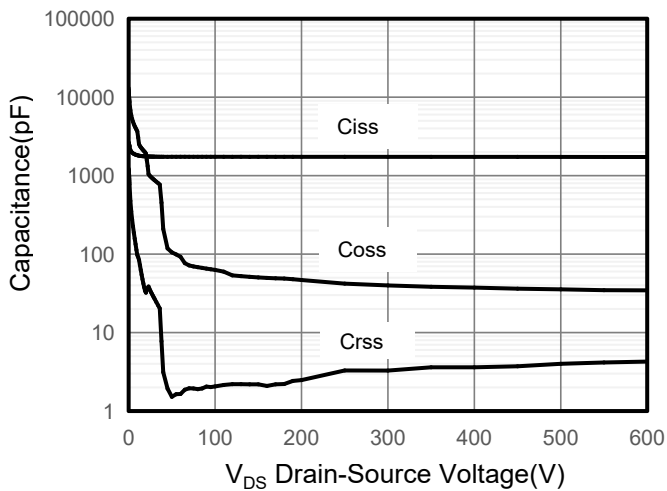
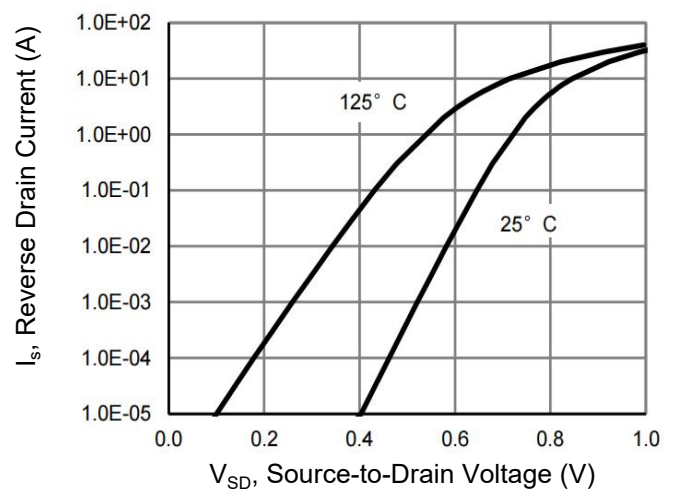

Figure 6. Source-Drain Diode Forward



Typical Characteristics $T_J = 25^\circ\text{C}$, unless otherwise noted

Figure 7. Drain-Source On-Resistance

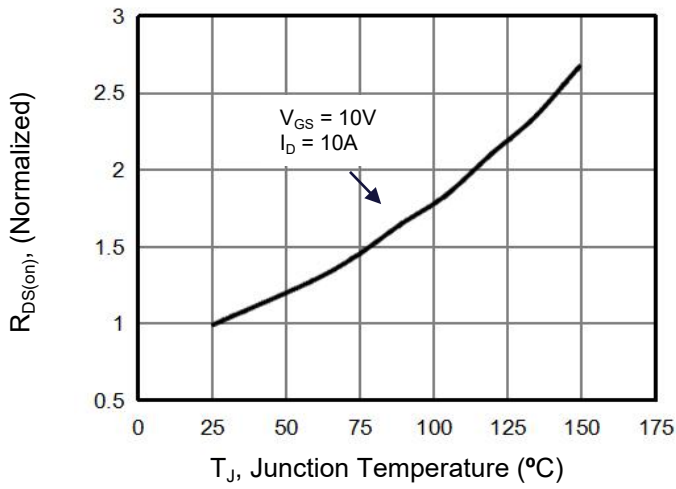

Figure 8. Safe Operation Area

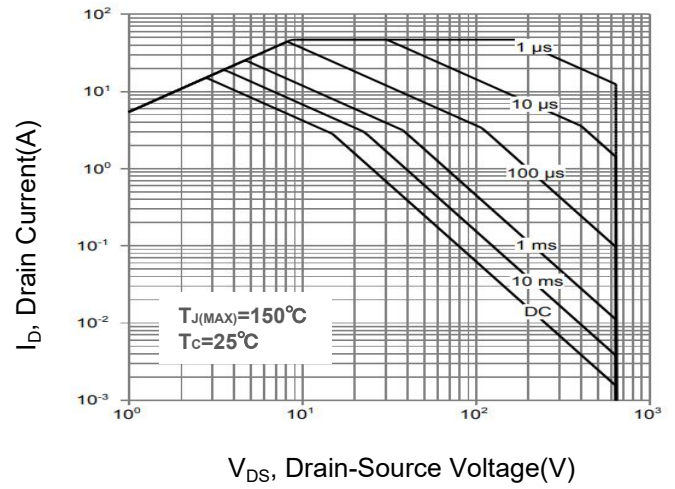
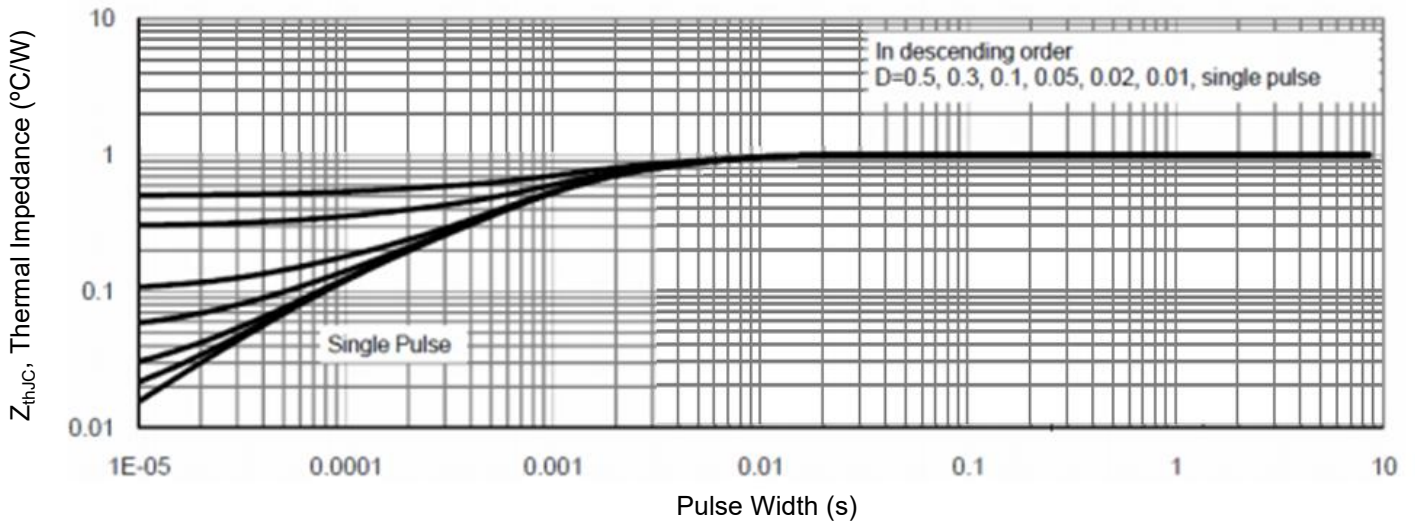
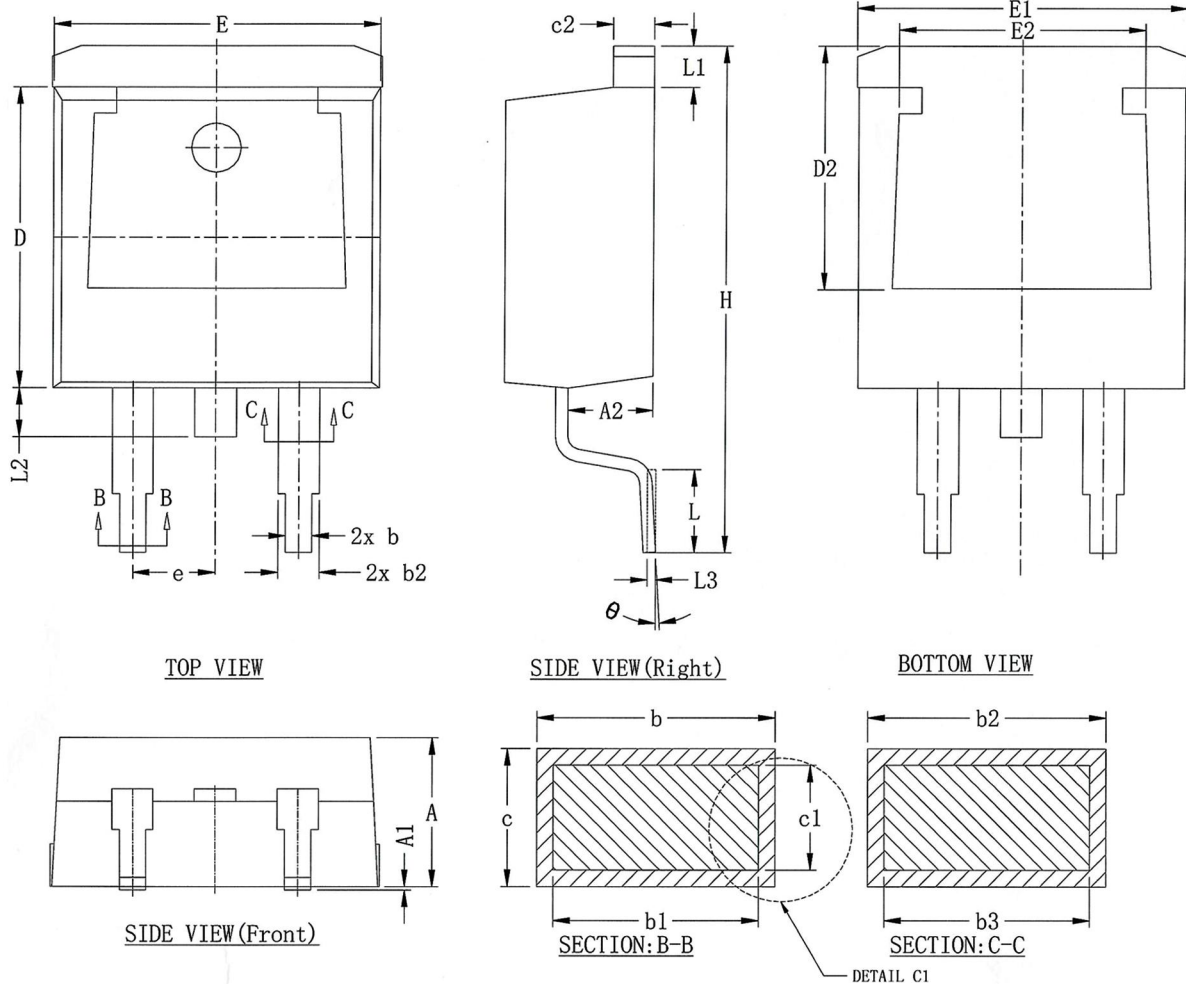

Figure 9. Normalized Maximum Transient Thermal Impedance



TO-263 Package Information



DIM SYMBOL	MIN.	NOM.	MAX.	DIM SYMBOL	MIN.	NOM.	MAX.
A	4.450	4.550	4.650	D2	7.215	7.415	7.615
A1	0.000	—	0.150	E	9.900	10.000	10.100
A2	2.500	2.600	2.700	E1	9.900	10.100	10.300
b	0.753	0.853	0.953	E2	7.341	7.541	7.741
b1	0.713	0.813	0.913	e	2.540 BSC.		
b2	1.210	1.310	1.410	H	15.300	15.500	15.700
b3	1.170	1.270	1.370	L	2.340	2.540	2.740
c	0.330	0.421	0.521	L1	1.066	1.266	1.466
c1	0.281	0.381	0.481	L2	1.400	1.500	1.600
c2	1.210	1.310	1.410	L3	0.254 BSC.		
D	9.100	9.200	9.300	θ	0°	---	5°