

## P-Channel Enhancement Mode Power MOSFET

### Description

The G450P15M uses advanced trench technology to provide excellent  $R_{DS(ON)}$ , low gate charge. It can be used in a wide variety of applications.

### General Features

- $V_{DS}$  -150V
- $I_D$  (at  $V_{GS} = -10V$ ) -120A
- $R_{DS(ON)}$  (at  $V_{GS} = -10V$ ) < 45m $\Omega$
- 100% Avalanche Tested
- RoHS Compliant

### Application

- Power switch
- DC/DC converters

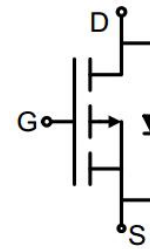

Schematic diagram

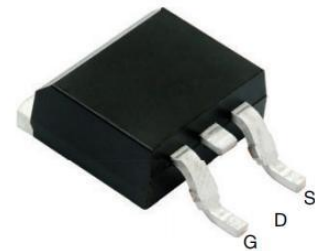

TO-263

### Ordering Information

Device	Package	Marking	Packaging
G450P15M	TO-263	G450P15	800pcs/Reel

### Absolute Maximum Ratings $T_C = 25^\circ\text{C}$ , unless otherwise noted

Parameter	Symbol	Value	Unit
Drain-Source Voltage	$V_{DS}$	-150	V
Continuous Drain Current	$I_D$	-120	A
Pulsed Drain Current (note1)	$I_{DM}$	-480	A
Gate-Source Voltage	$V_{GS}$	$\pm 20$	V
Power Dissipation	$P_D$	200	W
Single pulse avalanche energy (note2)	$E_{AS}$	440	mJ
Operating Junction and Storage Temperature Range	$T_J, T_{stg}$	-55 To 150	$^\circ\text{C}$

### Thermal Resistance

Parameter	Symbol	Value	Unit
Thermal Resistance, Junction-to-Ambient	$R_{thJA}$	50	$^\circ\text{C/W}$
Maximum Junction-to-Case	$R_{thJC}$	0.63	$^\circ\text{C/W}$

Specifications $T_J = 25^\circ\text{C}$ , unless otherwise noted						
Parameter	Symbol	Test Conditions	Value			Unit
			Min.	Typ.	Max.	
<b>Static Parameters</b>						
Drain-Source Breakdown Voltage	$V_{(BR)DSS}$	$V_{GS} = 0V, I_D = -250\mu A$	-150	--	--	V
Zero Gate Voltage Drain Current	$I_{DSS}$	$V_{DS} = -150V, V_{GS} = 0V$	--	--	-1	$\mu A$
Gate-Source Leakage	$I_{GSS}$	$V_{GS} = \pm 20V$	--	--	$\pm 100$	nA
Gate-Source Threshold Voltage	$V_{GS(th)}$	$V_{DS} = V_{GS}, I_D = -250\mu A$	-1.0	-2.5	-4.0	V
Drain-Source On-Resistance	$R_{DS(on)}$	$V_{GS} = -10V, I_D = -30A$	--	33	45	m $\Omega$
Forward Transconductance	$g_{FS}$	$V_{DS} = -5V, I_D = -30A$	--	27	--	S
<b>Dynamic Parameters</b>						
Input Capacitance	$C_{iss}$	$V_{GS} = 0V,$ $V_{DS} = -75V,$ $f = 1.0MHz$	--	7661	--	pF
Output Capacitance	$C_{oss}$		--	301	--	
Reverse Transfer Capacitance	$C_{rss}$		--	272	--	
Total Gate Charge	$Q_g$	$V_{DD} = -75V,$ $I_D = -30A,$ $V_{GS} = -10V$	--	177	--	nC
Gate-Source Charge	$Q_{gs}$		--	37	--	
Gate-Drain Charge	$Q_{gd}$		--	55	--	
Turn-on Delay Time	$t_{d(on)}$	$V_{DD} = -75V,$ $I_D = -30A,$ $R_G = 1.6\Omega$	--	12	--	ns
Turn-on Rise Time	$t_r$		--	42	--	
Turn-off Delay Time	$t_{d(off)}$		--	146	--	
Turn-off Fall Time	$t_f$		--	79	--	
<b>Drain-Source Body Diode Characteristics</b>						
Continuous Body Diode Current	$I_S$	$T_C = 25^\circ\text{C}$	--	--	-120	A
Body Diode Voltage	$V_{SD}$	$T_J = 25^\circ\text{C}, I_{SD} = -30A, V_{GS} = 0V$	--	--	-1.2	V
Reverse Recovery Charge	$Q_{rr}$	$I_F = -30A, V_{GS} = 0V$ $di/dt = -100A/\mu s$	--	523	--	nC
Reverse Recovery Time	$T_{rr}$		--	207	--	ns

### Notes

1. Repetitive Rating: Pulse width limited by maximum junction temperature
2. EAS condition :  $T_J = 25^\circ\text{C}, V_{DD} = 50V, V_{GS} = 10V, L = 0.5mH, R_G = 25\Omega$

The table shows the minimum avalanche energy, which is 1225mJ when the device is tested until failure

3. Identical low side and high side switch with identical  $R_G$

### Gate Charge Test Circuit



### Switch Time Test Circuit



### EAS Test Circuit



Typical Characteristics  $T_J = 25^\circ\text{C}$ , unless otherwise noted

Figure 1. Output Characteristics

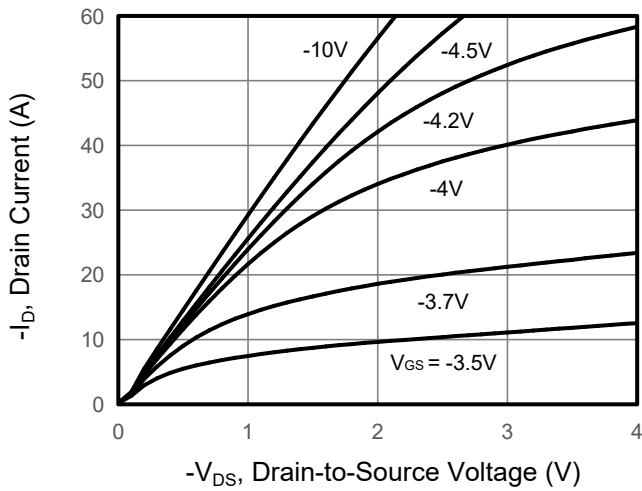

Figure 2. Transfer Characteristics

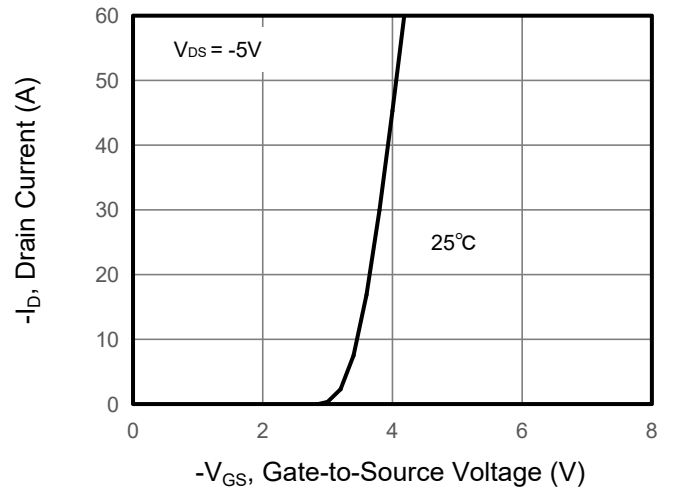

Figure 3. Drain Source On Resistance

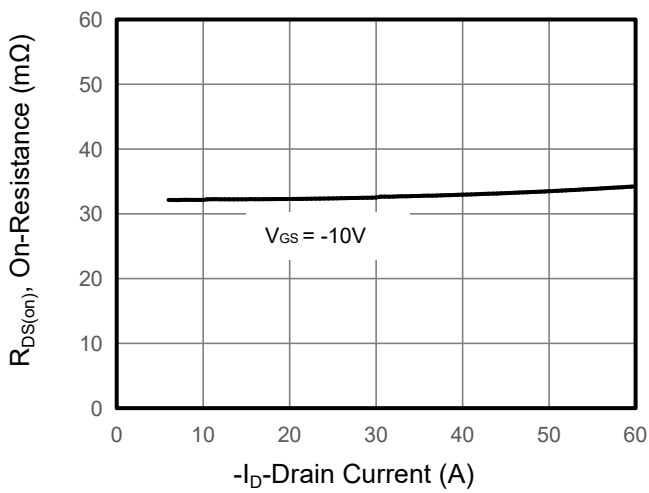

Figure 4. Gate Charge

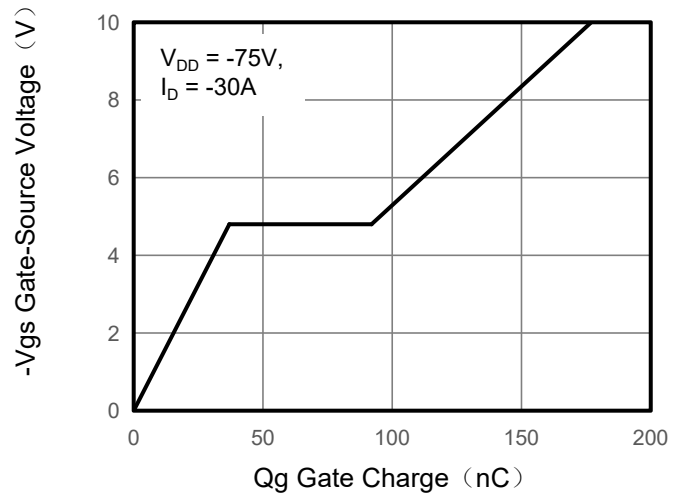

Figure 5. Capacitance

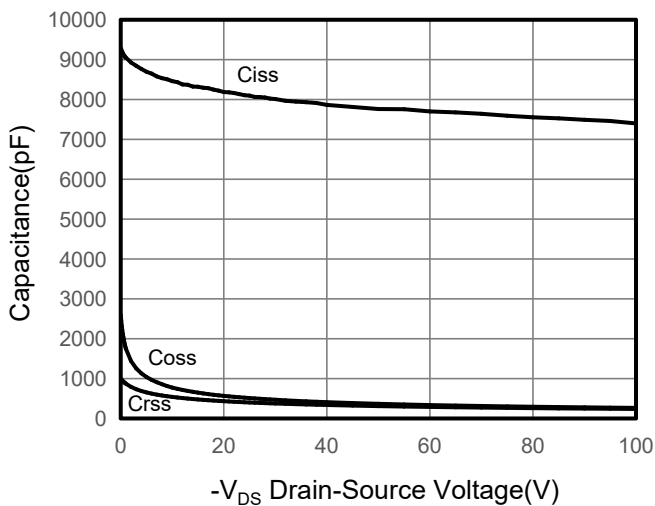
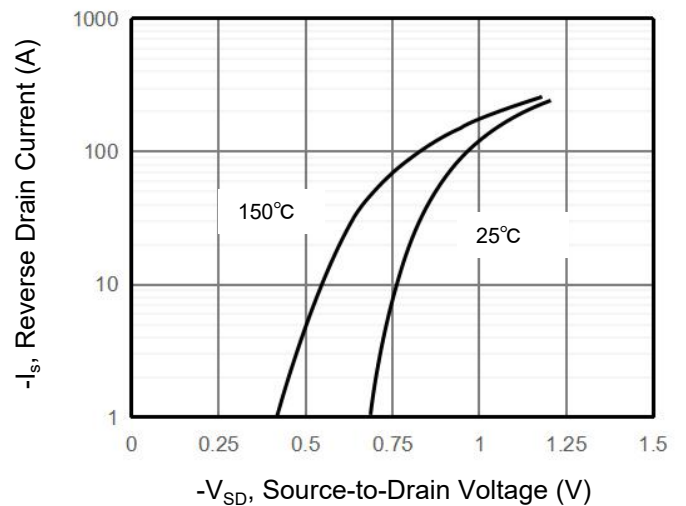

Figure 6. Source-Drain Diode Forward



Typical Characteristics  $T_J = 25^\circ\text{C}$ , unless otherwise noted

Figure 7. Drain-Source On-Resistance

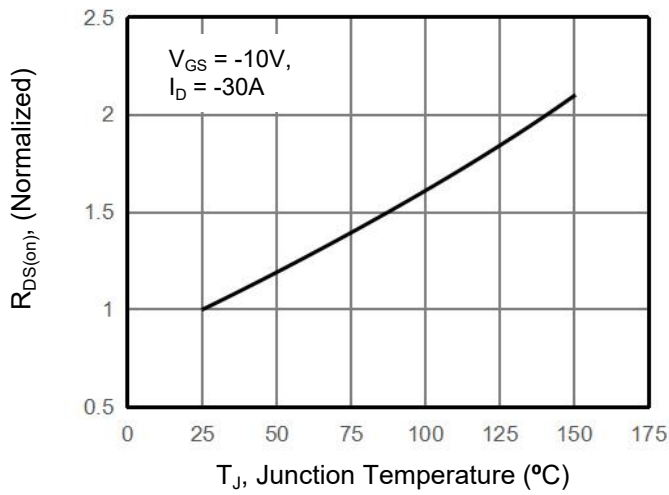

Figure 10. Safe Operation Area

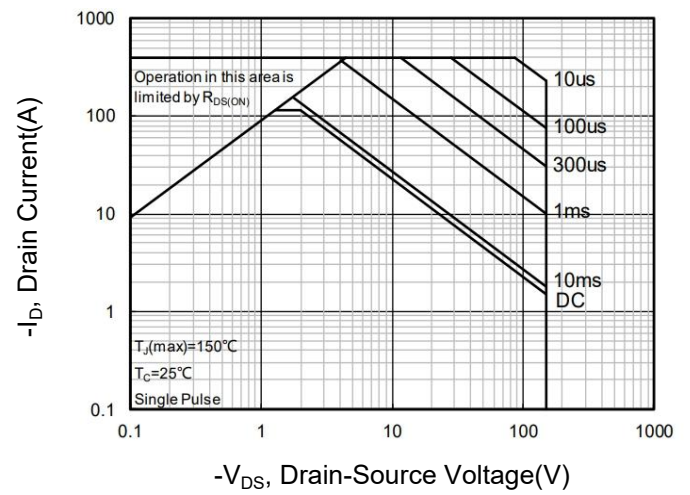
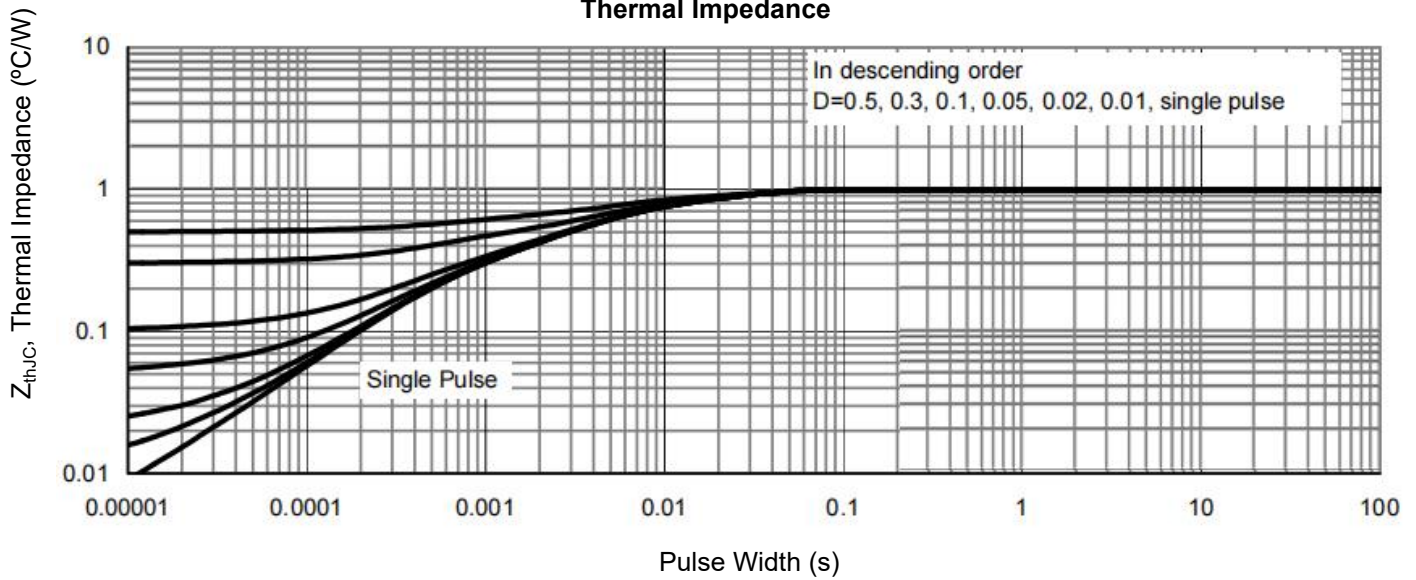
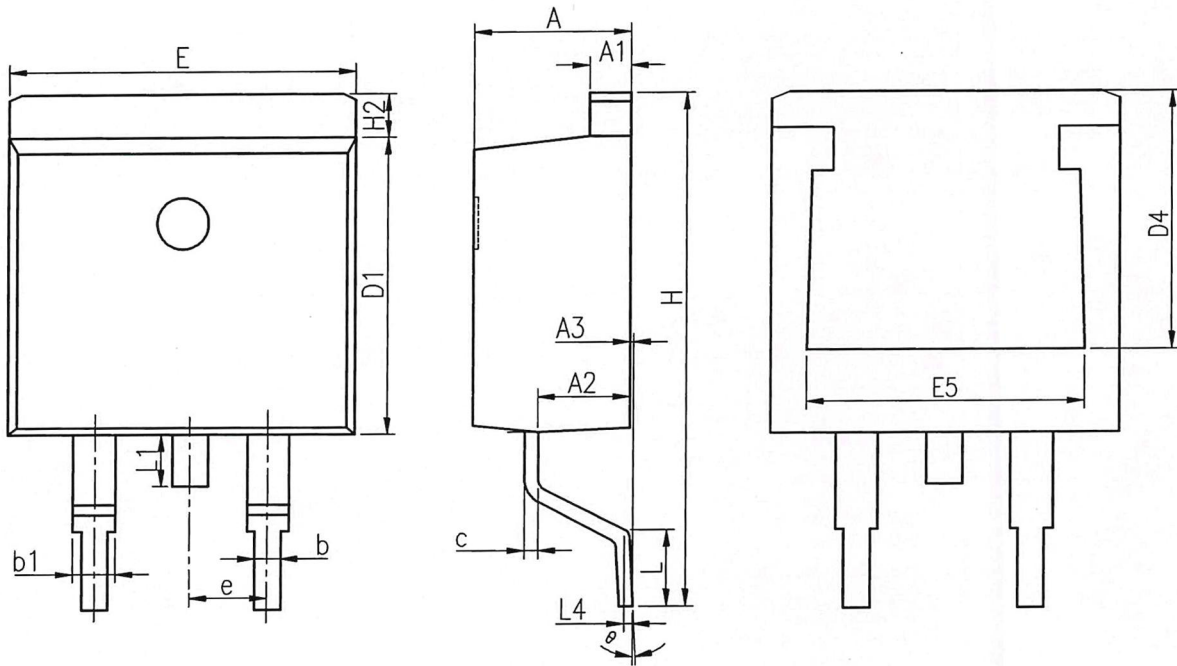

Figure 9. Normalized Maximum Transient Thermal Impedance



## TO-263 Package Information



### COMMON DIMENSIONS

SYMBOL	MM			SYMBOL	MM		
	MIN	NOM	MAX		MIN	NOM	MAX
A	4.37	4.57	4.77	E	9.86	10.16	10.36
A1	1.22	1.27	1.42	E5	7.06	-	-
A2	2.49	2.69	2.89	e	2.54 BSC		
A3	0.00	0.13	0.25	H	14.70	15.10	15.50
b	0.70	0.81	0.96	H2	1.07	1.27	1.47
b1	1.17	1.27	1.47	L	2.00	2.30	2.60
c	0.30	0.38	0.53	L1	1.40	1.55	1.70
D1	8.50	8.70	8.90	L4	0.25 BSC		
D4	6.60	-	-	θ	0°	5°	9°