

P-Channel Enhancement Mode Power MOSFET

Description

The G170P06M uses advanced trench technology to provide excellent $R_{DS(ON)}$, low gate charge. It can be used in a wide variety of applications.

General Features

- V_{DS} -60V
- I_D (at $V_{GS} = -10V$) -65A
- $R_{DS(ON)}$ (at $V_{GS} = -10V$) < 17m Ω
- 100% Avalanche Tested
- RoHS Compliant

Application

- Power switch
- DC/DC converters

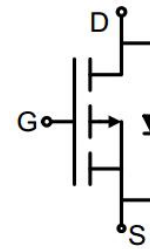

Schematic diagram

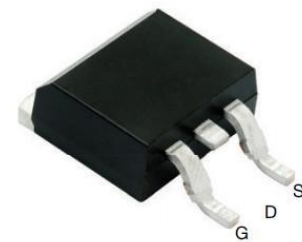

TO-263

Ordering Information

Device	Package	Marking	Packaging
G170P06M	TO-263	G170P06	800pcs/Reel

Absolute Maximum Ratings $T_C = 25^\circ\text{C}$, unless otherwise noted

Parameter	Symbol	Value	Unit
Drain-Source Voltage	V_{DS}	-60	V
Continuous Drain Current	I_D	-65	A
Pulsed Drain Current (note1)	I_{DM}	-260	A
Gate-Source Voltage	V_{GS}	± 20	V
Power Dissipation	P_D	130	W
Single pulse avalanche energy (note2)	E_{AS}	196	mJ
Operating Junction and Storage Temperature Range	T_J, T_{stg}	-55 To 150	$^\circ\text{C}$

Thermal Resistance

Parameter	Symbol	Value	Unit
Thermal Resistance, Junction-to-Ambient	R_{thJA}	62	$^\circ\text{C/W}$
Maximum Junction-to-Case	R_{thJC}	0.96	$^\circ\text{C/W}$

Specifications $T_J = 25^\circ\text{C}$, unless otherwise noted						
Parameter	Symbol	Test Conditions	Value			Unit
			Min.	Typ.	Max.	
Static Parameters						
Drain-Source Breakdown Voltage	$V_{(BR)DSS}$	$V_{GS} = 0V, I_D = -250\mu A$	-60	--	--	V
Zero Gate Voltage Drain Current	I_{DSS}	$V_{DS} = -60V, V_{GS} = 0V$	--	--	-1	μA
Gate-Source Leakage	I_{GSS}	$V_{GS} = \pm 20V$	--	--	± 100	nA
Gate-Source Threshold Voltage	$V_{GS(th)}$	$V_{DS} = V_{GS}, I_D = -250\mu A$	-2.0	-2.5	-3.5	V
Drain-Source On-Resistance	$R_{DS(on)}$	$V_{GS} = -10V, I_D = -20A$	--	12	17	m Ω
Forward Transconductance	g_{FS}	$V_{DS} = -5V, I_D = -20A$	--	22	--	S
Dynamic Parameters						
Input Capacitance	C_{iss}	$V_{GS} = 0V,$ $V_{DS} = -30V,$ $f = 1.0\text{MHz}$	--	6451	--	pF
Output Capacitance	C_{oss}		--	377	--	
Reverse Transfer Capacitance	C_{rss}		--	343	--	
Total Gate Charge	Q_g	$V_{DD} = -30V,$ $I_D = -20A,$ $V_{GS} = -10V$	--	75	--	nC
Gate-Source Charge	Q_{gs}		--	16	--	
Gate-Drain Charge	Q_{gd}		--	19	--	
Turn-on Delay Time	$t_{d(on)}$	$V_{DD} = -30V,$ $I_D = -20A,$ $R_G = 3\Omega$	--	20	--	ns
Turn-on Rise Time	t_r		--	18	--	
Turn-off Delay Time	$t_{d(off)}$		--	55	--	
Turn-off Fall Time	t_f		--	35	--	
Drain-Source Body Diode Characteristics						
Continuous Body Diode Current	I_S	$T_C = 25^\circ\text{C}$	--	--	-65	A
Body Diode Voltage	V_{SD}	$T_J = 25^\circ\text{C}, I_{SD} = -20A, V_{GS} = 0V$	--	--	-1.2	V
Reverse Recovery Charge	Q_{rr}	$I_F = -20A, V_{GS} = 0V$ $di/dt = -100A/\mu s$	--	71	--	nC
Reverse Recovery Time	T_{rr}		--	49	--	ns

Notes

1. Repetitive Rating: Pulse width limited by maximum junction temperature
2. EAS condition : $T_J = 25^\circ\text{C}, V_{DD} = -50V, V_{GS} = -10V, L = 0.5\text{mH}, R_G = 25\Omega$
3. Identical low side and high side switch with identical R_G

Gate Charge Test Circuit



Switch Time Test Circuit



EAS Test Circuit



Typical Characteristics $T_J = 25^\circ\text{C}$, unless otherwise noted

Figure 1. Output Characteristics

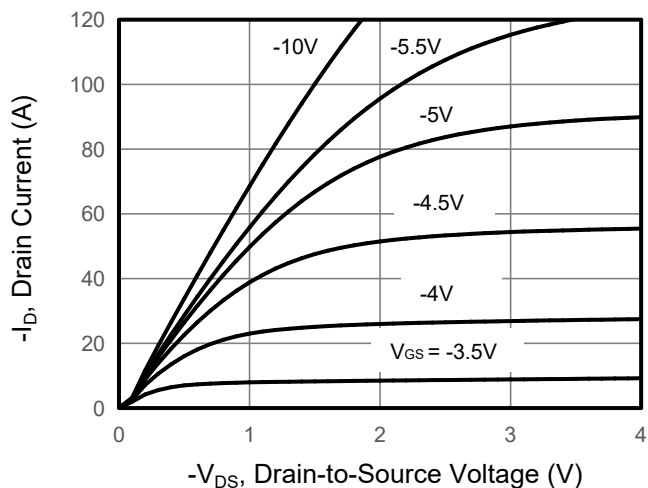

Figure 2. Transfer Characteristics

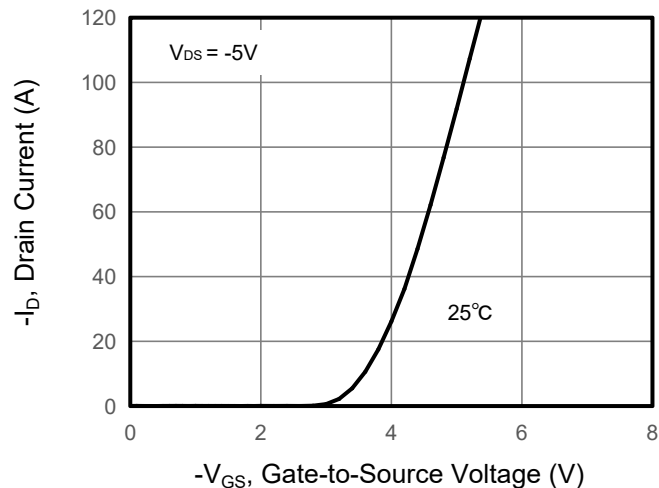

Figure 3. Drain Source On Resistance

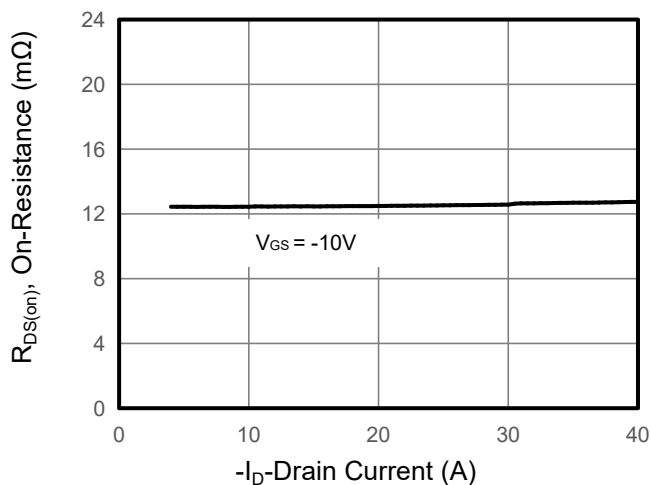

Figure 4. Gate Charge

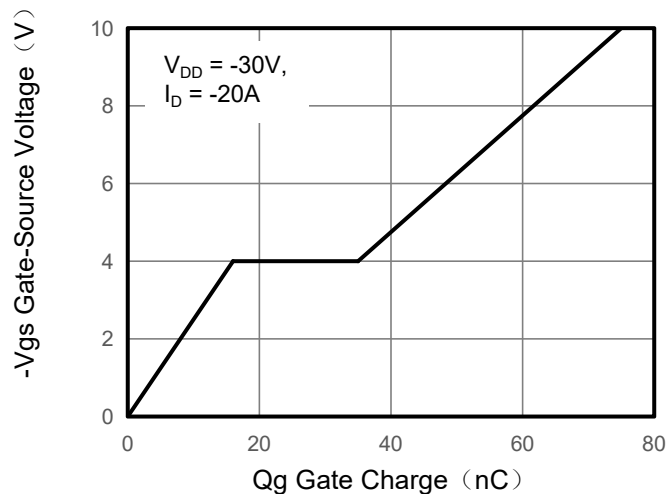

Figure 5. Capacitance

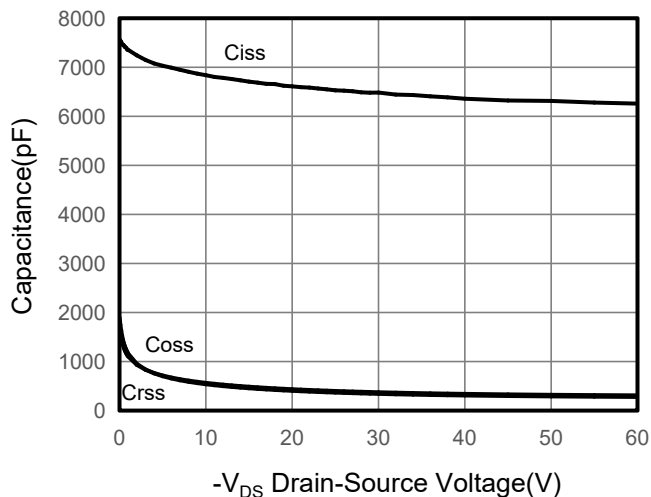
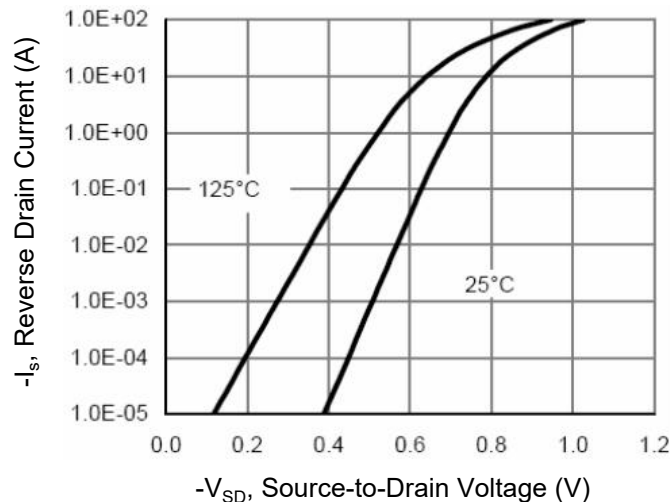

Figure 6. Source-Drain Diode Forward



Typical Characteristics $T_J = 25^\circ\text{C}$, unless otherwise noted

Figure 7. Drain-Source On-Resistance

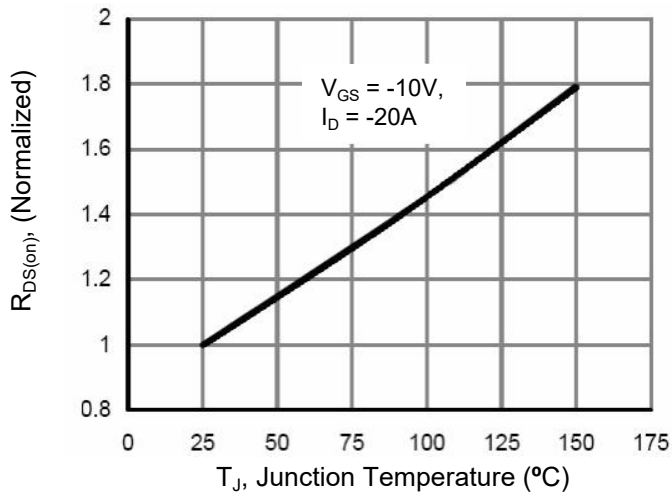

Figure 10. Safe Operation Area

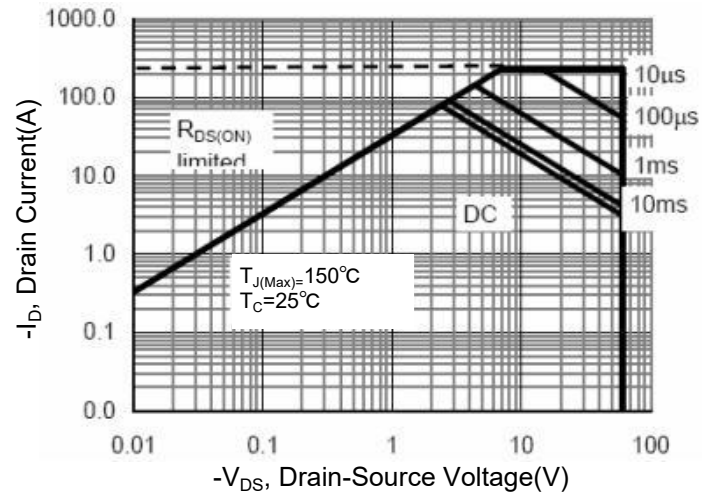
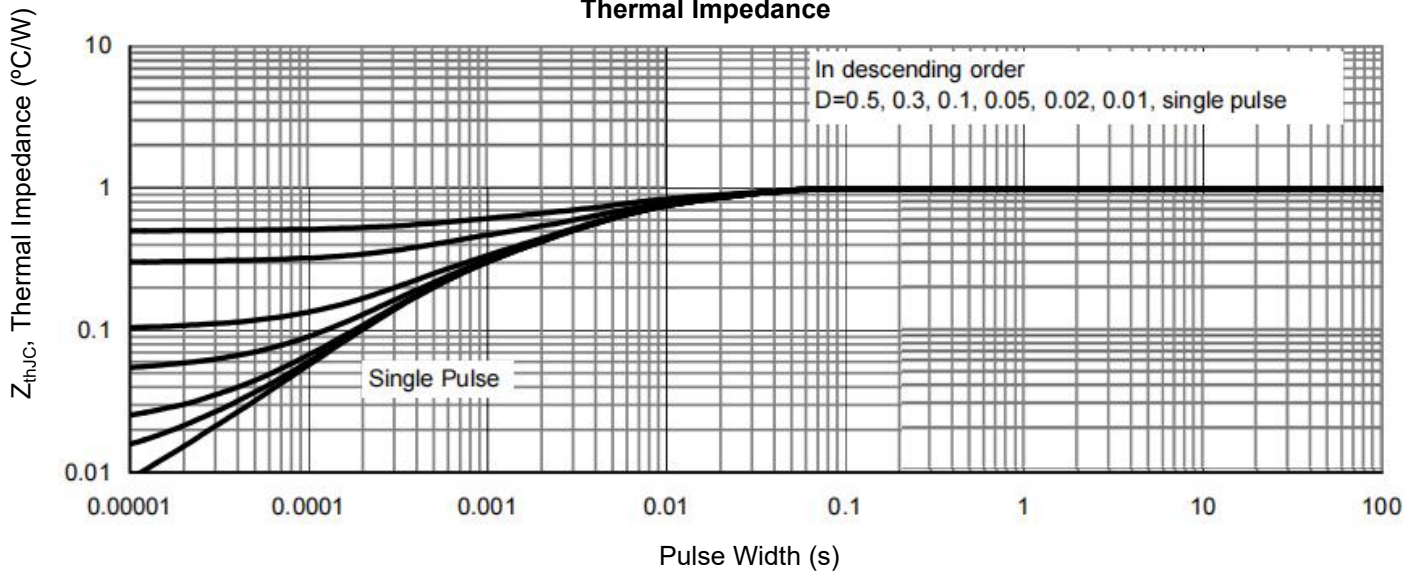
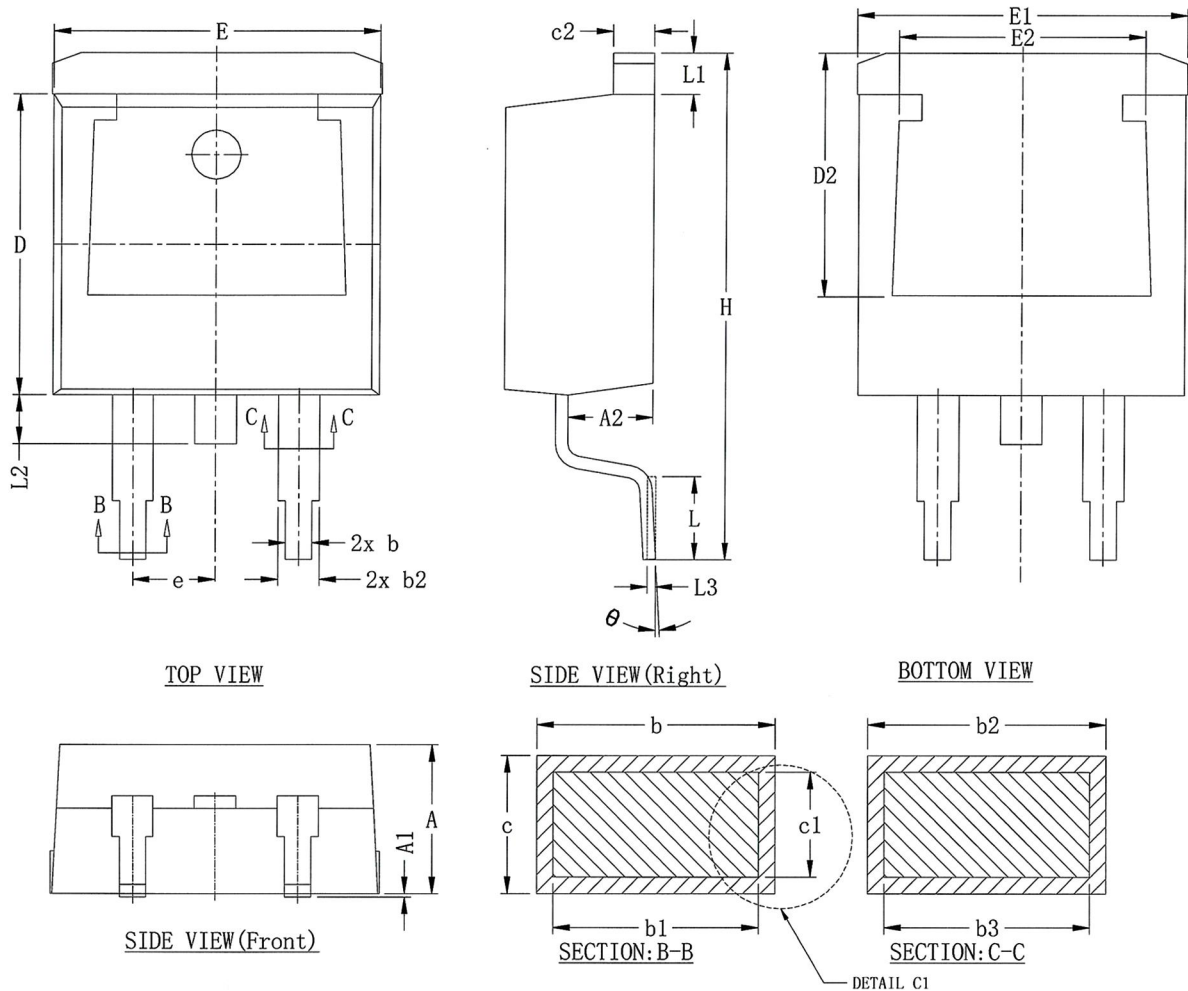

Figure 9. Normalized Maximum Transient Thermal Impedance



TO-263 Package Information



DIM SYMBOL	MIN.	NOM.	MAX.	DIM SYMBOL	MIN.	NOM.	MAX.
A	4.450	4.550	4.650	D2	7.215	7.415	7.615
A1	0.000	—	0.150	E	9.900	10.000	10.100
A2	2.500	2.600	2.700	E1	9.900	10.100	10.300
b	0.753	0.853	0.953	E2	7.341	7.541	7.741
b1	0.713	0.813	0.913	e	2.540 BSC.		
b2	1.210	1.310	1.410	H	15.300	15.500	15.700
b3	1.170	1.270	1.370	L	2.340	2.540	2.740
c	0.330	0.421	0.521	L1	1.066	1.266	1.466
c1	0.281	0.381	0.481	L2	1.400	1.500	1.600
c2	1.210	1.310	1.410	L3	0.254 BSC.		
D	9.100	9.200	9.300	θ	0°	---	5°