

Switching Diodes

■ Features

- Fast Switching Speed
- Surface Mount Package Ideally Suited for Automatic Insertion
- High Conductance
- For General Purpose Switching Applications

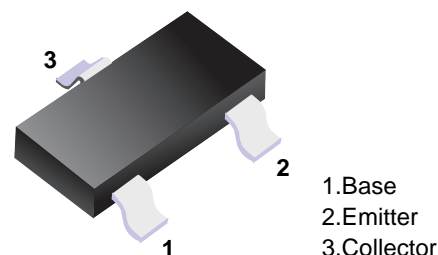

■ Simplified outline(SOT-23)

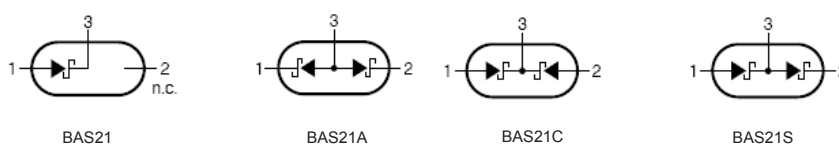

■ Absolute Maximum Ratings $T_a = 25^\circ\text{C}$

Parameter	Symbol	Rating	Unit
Reverse Voltage	V_R	250	V
Forward Current	I_F	200	mA
Power Dissipation	P_D	200	mW
Operating Junction Temperature Range	T_J	-55 to +150	$^\circ\text{C}$
Storage Temperature Range	T_{stg}	-55 to +150	$^\circ\text{C}$

■ Electrical Characteristics $T_a = 25^\circ\text{C}$

Parameter	Symbol	Testconditions	Min	Typ	Max	Unit
Reverse Breakdown Voltage	$V_{(BR)}$	$I_R=100\ \mu\text{A}$	250			V
Forward Voltage	V_F	$I_F=100\text{mA}$ $I_F=200\text{mA}$			1.0 1.25	V
Reverse Leakage	I_R	$V_R=200\text{V}$			100	nA
Junction Capacitance	C_j	$V_R=0\text{V}, f=1.0\text{MHz}$			5.0	pF
Reverse Recover Time	T_{rr}				50	nS

■ Marking

NO.	BAS21	BAS21A	BAS21C	BAS21S
Marking	JS	JS2	JS3	JS4

■ Typical Characteristics

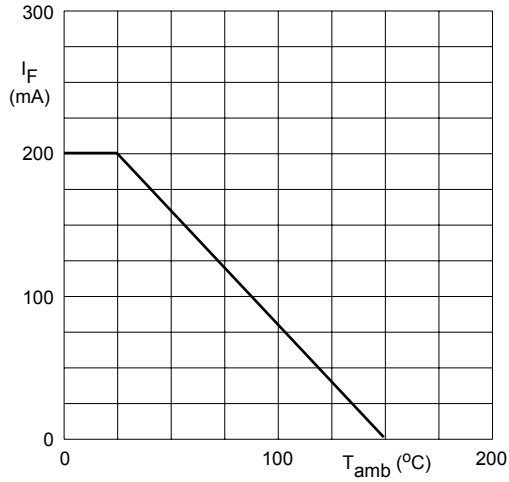

Device mounted on an FR4 printed-circuit board.

Fig.1 Maximum permissible continuous forward current as a function of ambient temperature.

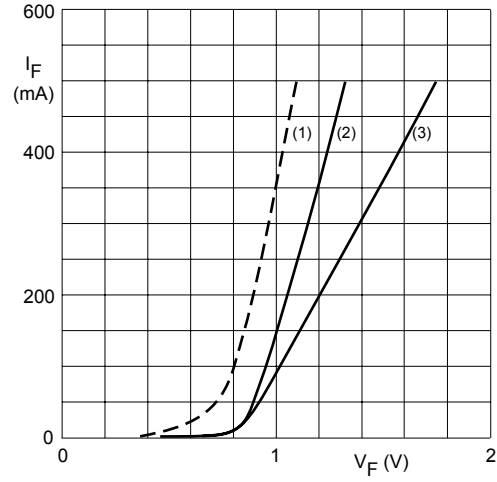

- (1) $T_j = 150$ °C; typical values.
- (2) $T_j = 25$ °C; typical values.
- (3) $T_j = 25$ °C; maximum values.

Fig.2 Forward current as a function of forward voltage.

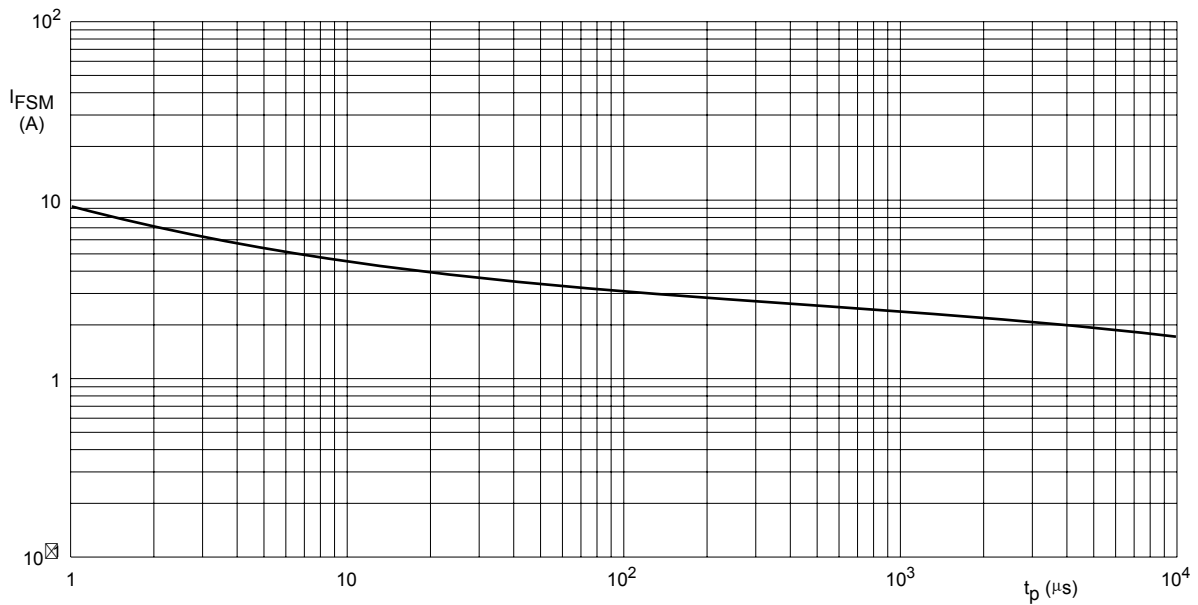

Based on square wave currents.
 $T_j = 25$ °C prior to surge.

Fig.3 Maximum permissible non-repetitive peak forward current as a function of pulse duration.

■ Typical Characteristics

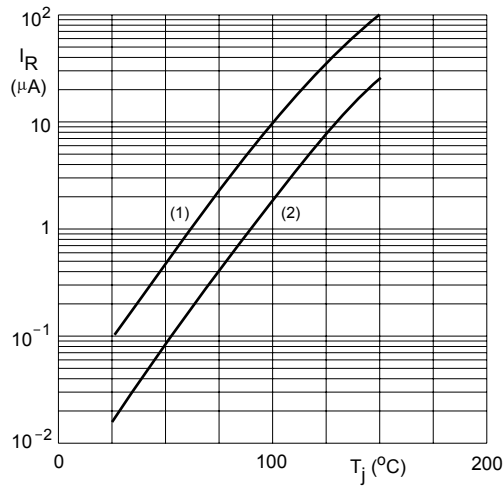

- (1) $V_R = V_{Rmax}$; maximum values.
 (2) $V_R = V_{Rmax}$; typical values.

Fig.5 Reverse current as a function of junction temperature.

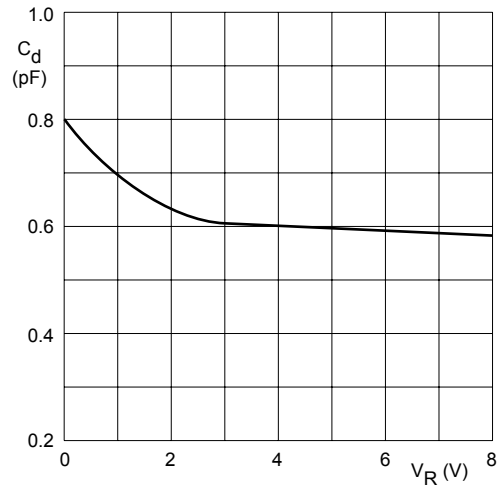

$f = 1 \text{ MHz}; T_j = 25 \text{ °C}.$

Fig.6 Diode capacitance as a function of reverse voltage; typical values.

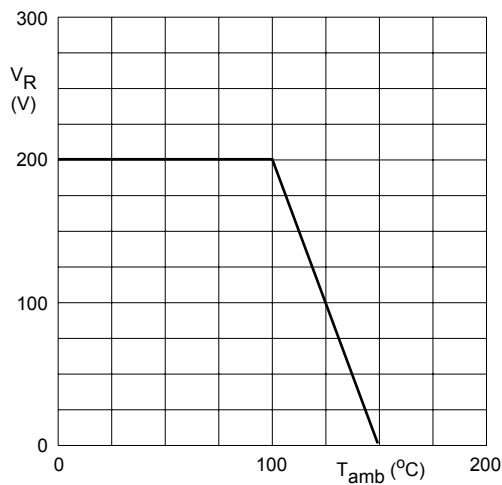
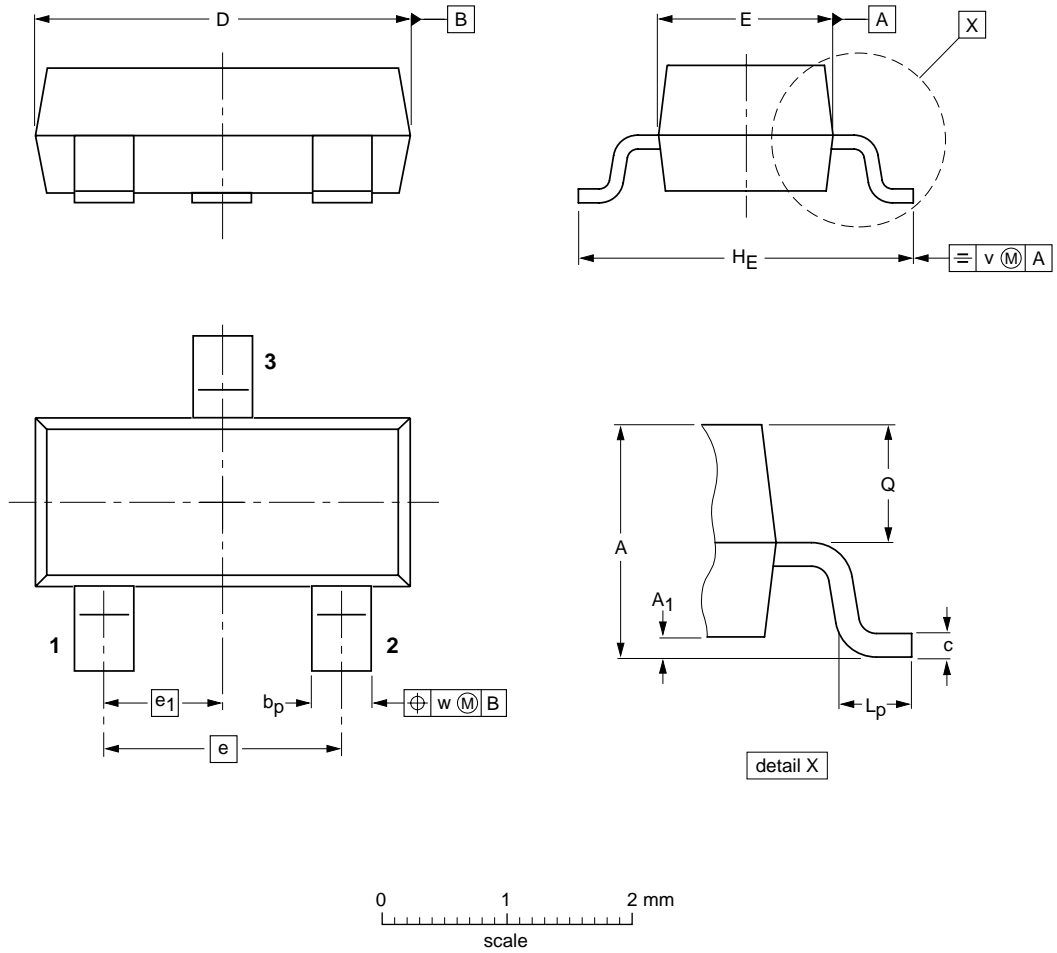

Fig.7 Maximum permissible continuous reverse voltage as a function of the ambient temperature.

■ SOT-23



DIMENSIONS (mm are the original dimensions)

UNIT	A	A ₁ max.	b _p	c	D	E	e	e ₁	H _E	L _p	Q	v	w
mm	1.1 0.9	0.1	0.48 0.38	0.15 0.09	3.0 2.8	1.4 1.2	1.9	0.95	2.5 2.1	0.45 0.15	0.55 0.45	0.2	0.1