

THB AC and Pulse Metallized Polypropylene Film Capacitors

High Temperature AEC-Q200 Qualified

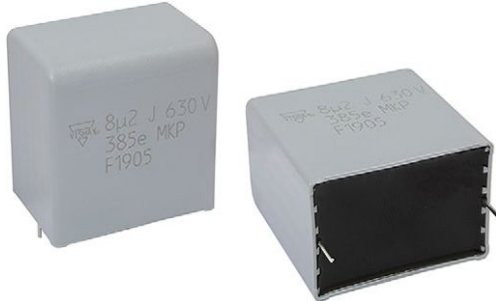



FEATURES

- AEC-Q200 qualified (rev. D)
- THB 60 °C 93 % RH for 56 days at rated voltage
- High temperature capabilities, up to 125 °C
- Customization on request
- Material categorization: for definitions of compliance please see www.vishay.com/doc?99912

RoHS
COMPLIANT

APPLICATIONS

- Hybrid and electrical vehicles applications
- On-board and inductive charging systems
 - BMS (battery management)
 - High pulse and high frequency currents
 - Snubbing
 - Resonant converters

QUICK REFERENCE DATA	
Rated capacitance range (E12 series)	0.001 μ F to 15 μ F
Capacitance tolerance	$\pm 5\%$ / $\pm 10\%$
Rated voltage range, U_{RDC}	400 V_{DC} , 630 V_{DC} , 850 V_{DC} , 1000 V_{DC} , 1250 V_{DC} , 1600 V_{DC} , 2000 V_{DC} , 2500 V_{DC}
Permissible AC voltage	200 V_{AC} , 220 V_{AC} , 300 V_{AC} , 350 V_{AC} , 450 V_{AC} , 550 V_{AC} , 700 V_{AC} , 800 V_{AC}
Climatic testing class	40 / 105 / 56
Rated temperature	85 °C
Max. operation temperature	105 °C up to 125 °C observing voltage derating
Reference standards	IEC 60384-17, AEC-Q200 qualified (rev. D) up to 105 °C
Dielectric	Polypropylene film
Electrodes	Metallized
Construction	Mono construction (for $\leq 630 V_{DC}$)  Series construction (for $> 630 V_{DC}$) 
Encapsulation	Plastic case, epoxy resin sealed, flame retardant UL-class 94 V-0
Leads	Tinned wire
Withstanding DC voltage between terminals ⁽¹⁾	1.6 U_{RDC} for 60 s (maximum rise time 1000 V/s; cut off current 10 mA)
Test voltage between terminals and case	1.4 U_{RAC} + 2000 V_{DC} for 60 s
Insulation resistance	RC between leads, after 1 min: for $U_{RDC} < 500 V$ measuring voltage 100 V for $U_{RDC} \geq 500 V$ measuring voltage 500 V > 100 G Ω for $C \leq 0.33 \mu$ F > 30 000 s for $C > 0.33 \mu$ F
Marking	C-value, tolerance, rated voltage, code for dielectric material, manufacturer location, manufacturer's type, manufacturer's logo, year and week

Notes

- For more detailed data and test requirements, contact dc-film@vishay.com
- ⁽¹⁾ See document "Voltage Proof Test for Metallized Capacitors" www.vishay.com/doc?28169



VOLTAGE RATINGS AND TEMPERATURE								
VOLTAGE RATINGS $T_{amb} = 85\text{ }^{\circ}\text{C}$								
Rated DC voltage U_{RDC}	400	630	850	1000	1250	1600	2000	2500
Rated AC voltage U_{RAC}	200	220	300	350	450	550	700 ⁽¹⁾	800
Rated peak to peak voltage V_{p-p} ($2 \times U_{RAC} \times \sqrt{2}$)	560	620	850	1000	1250	1600	2000 ⁽¹⁾	2250
Peak voltage V_{o-p} ($U_{RDC} \times 1.6$)	640	1008	1360	1600	2000	2560	3200	4000
Maximum temporary RMS over voltage (< 24 h) ($1.25 \times U_{RAC}$)	250	275	375	438	563	688	875	1000
VOLTAGE RATINGS $85\text{ }^{\circ}\text{C} < T_{amb} \leq 105\text{ }^{\circ}\text{C}$								
U_{OPDC} ($U_{RDC} \times 0.7$)	280	441	595	700	875	1120	1400	1750
U_{OPAC} ($U_{RAC} \times 0.7$)	140	154	210	245	315	385	490 ⁽²⁾	560
Rated peak to peak voltage V_{p-p} ($2 \times U_{OPAC} \times \sqrt{2}$)	396	436	594	693	891	1089	1386 ⁽²⁾	1584
Peak voltage V_{o-p} ($U_{RDC} \times 1.1$)	440	693	935	1100	1375	1760	2200	2750
Maximum temporary RMS over voltage (< 24 h) ($0.875 \times U_{RAC}$)	175	193	263	306	394	481	613 ⁽²⁾	700
VOLTAGE RATINGS $105\text{ }^{\circ}\text{C} < T_{amb} \leq 125\text{ }^{\circ}\text{C}$ (for limited time < 500 h)								
U_{OPDC} ($U_{RDC} \times 0.5$)	200	315	425	500	625	800	1000	1250
U_{OPAC} ($U_{RAC} \times 0.5$)	100	110	150	175	225	275	350 ⁽³⁾	400
Rated peak to peak voltage V_{p-p} ($2 \times U_{OPAC} \times \sqrt{2}$)	283	311	424	495	636	778	990 ⁽³⁾	1131
Peak voltage V_{o-p} ($U_{RDC} \times 0.8$)	320	504	680	800	1000	1280	1600	2000
Maximum temporary RMS over voltage (< 24 h) ($0.625 \times U_{RAC}$)	125	138	188	219	281	344	438 ⁽³⁾	500

Notes

- (1) Rated AC voltage is 600 V_{AC} and rated peak to peak voltage is 1700 V_{AC} for pitch 37.5 mm
- (2) U_{OPAC} ($U_{RAC} \times 0.7$) = 420 V_{AC} ; peak to peak voltage V_{p-p} ($2 \times U_{OPAC} \times \sqrt{2}$) = 1188 V; maximum temporary RMS over voltage (< 24 h) ($0.875 \times U_{RAC}$) = 525 V_{AC}
- (3) (U_{OPAC} ($U_{RAC} \times 0.5$) = 300 V_{AC} ; Peak to peak voltage V_{p-p} ($2 \times U_{OPAC} \times \sqrt{2}$) = 849 V; maximum temporary RMS over voltage (< 24 h) ($0.625 \times U_{RAC}$) = 375 V_{AC}

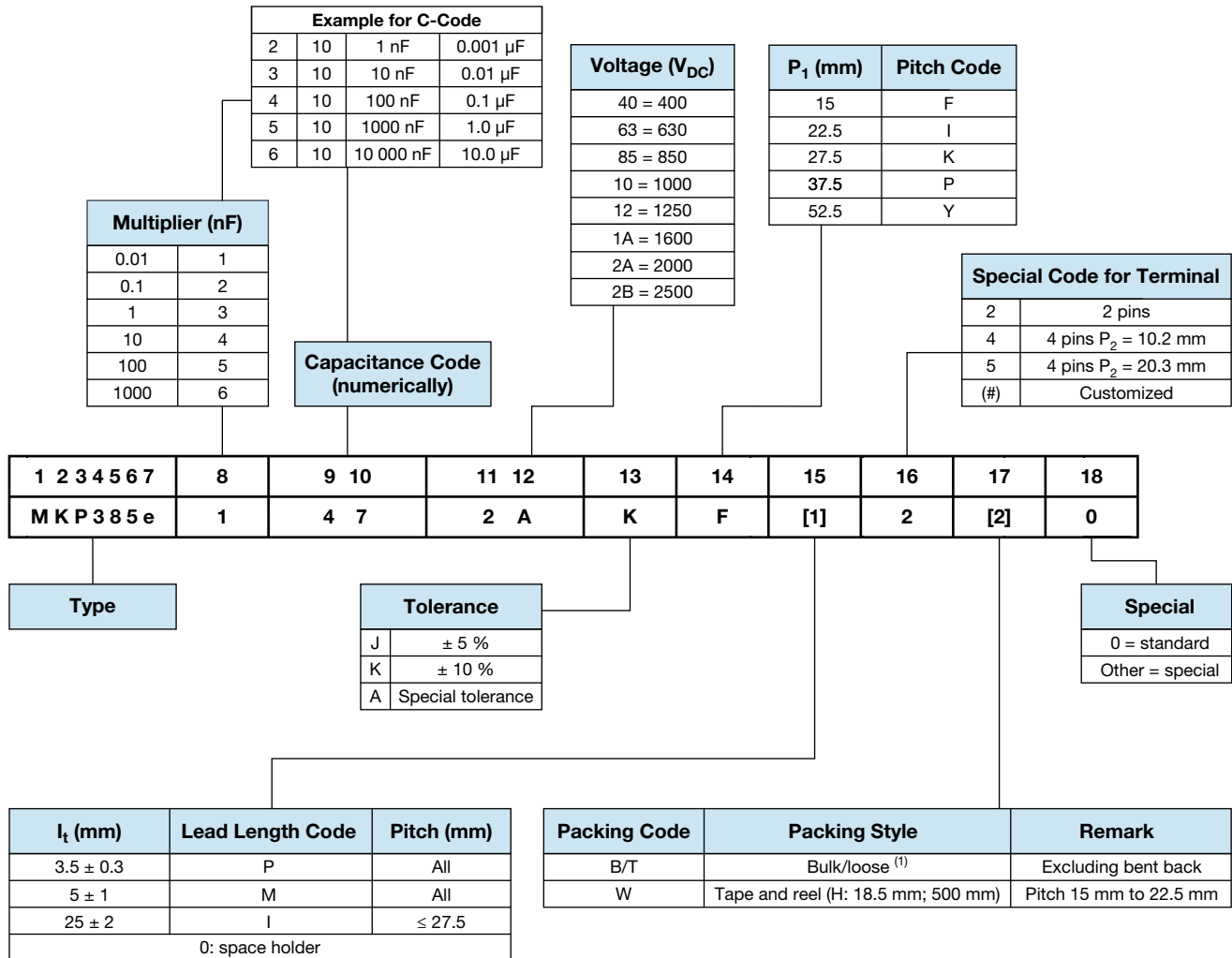
COMPOSITION OF CATALOG NUMBER

Notes

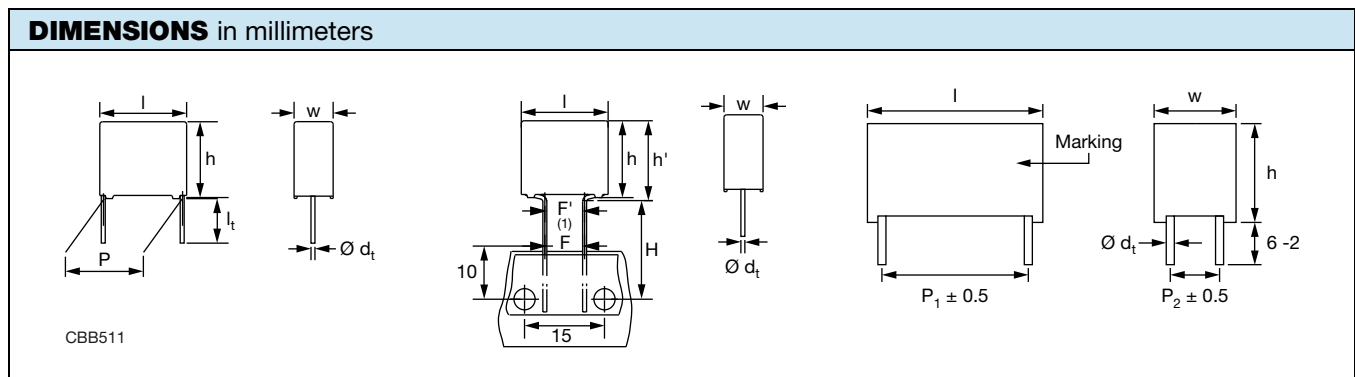
- For detailed tape specifications refer to packaging information www.vishay.com/doc?28139
- (1) Capacitors with short leads up to 5 mm and pitch > 15 mm will be in tray and asking code will be "T"

Note

- (1) $|F - F'| < 0.3$ mm
 $F = 7.5$ mm + 0.6 mm / - 0.1 mm
 $\text{Ø } d_t = 0.80$ mm $\pm 10\%$ for $P < 37.5$ mm and $\text{Ø } d_t = 0.95$ mm $\pm 10\%$ for $P \geq 37.5$ mm



ELECTRICAL DATA AND ORDERING CODE																
U _{RDC} (V)	CAP. (µF)	DIMENSION w x h x l (mm)	P1 (mm)	P2 (mm)	du/dt (V/µs) _R	I _{PEAK} (A)	I _{RMS} ⁽¹⁾ (A)		ESR ⁽²⁾ (mΩ)		tan δ ⁽³⁾ (10 ⁻⁴)		ORDERING CODE ⁽⁴⁾ MKP385e....			
							2 PINS	4 PINS	2 PINS	4 PINS	2 PINS	4 PINS				
U_{RAC} = 200 V, U_{p-p} = 560 V, C-TOL. = ± 10 %																
400	0.047	7.0 x 13.5 x 17.5	15	-	130	5.4	2.0	-	51	-	30	-	34740KF[1]2[2]0			
	0.056					6.4	2.2	-	44	-	30	-	35640KF[1]2[2]0			
	0.068					7.8	2.2	-	43	-	35	-	36840KF[1]2[2]0			
	0.082					9.4	2.4	-	35	-	35	-	38240KF[1]2[2]0			
	0.10					11.5	2.5	-	32	-	40	-	41040KF[1]2[2]0			
	0.12					13.8	2.6	-	31	-	45	-	41240KF[1]2[2]0			
	0.15					17.3	3.1	-	25	-	45	-	41540KF[1]2[2]0			
	0.18	8.5 x 15.0 x 17.5				20.7	3.1	-	25	-	50	-	41840KF[1]2[2]0			
	0.22					25.3	3.4	-	22	-	65	-	42240KF[1]2[2]0			
	0.27					31.1	4.0	-	18	-	70	-	42740KF[1]2[2]0			
	0.33	10.0 x 16.5 x 17.5				38.0	3.9	-	18	-	70	-	43340KF[1]2[2]0			
	0.39					44.9	4.3	-	16	-	75	-	43940KF[1]2[2]0			
	0.47	11.0 x 18.5 x 18.0				54.1	4.8	-	15	-	75	-	44740KF[1]2[2]0			
	0.22	7.0 x 16.5 x 26.0				22.5	-	115	28.6	3.0	-	37	-	70	-	42240KI[1]2[2]0
	0.27		35.1	3.1	-				34	-	70	-	42740KI[1]2[2]0			
	0.33	42.9	3.7	-	28				-	70	-	43340KI[1]2[2]0				
	0.39	8.5 x 18.0 x 26.0	50.7	3.8	-				26	-	75	-	43940KI[1]2[2]0			
	0.47		61.1	4.3	-				24	-	75	-	44740KI[1]2[2]0			
	0.56	10.0 x 19.5 x 26.0	72.8	4.7	-				20	-	95	-	45640KI[1]2[2]0			
	0.68		88.4	5.3	-				18	-	100	-	46840KI[1]2[2]0			
	0.82	12.0 x 22.0 x 26.0	106.6	5.8	-				15	-	105	-	48240KI[1]2[2]0			
	1.00		130.0	6.1	-				14	-	110	-	51040KI[1]2[2]0			
	1.20		156.0	6.8	-				12	-	110	-	51240KI[1]2[2]0			
	0.47	9.0 x 19.0 x 31.0	27.5	-	80				37.6	4.0	-	28	-	95	-	44740KK[1]2[2]0
	0.56								44.8	4.3	-	24	-	100	-	45640KK[1]2[2]0
	0.68	54.4							4.9	-	21	-	100	-	46840KK[1]2[2]0	
	0.82	11.0 x 21.0 x 31.0							65.6	5.4	-	18	-	105	-	48240KK[1]2[2]0
	1.0					80.0	5.7	-	16	-	110	-	51040KK[1]2[2]0			
	1.2	13.0 x 23.0 x 31.0				96.0	6.3	-	15	-	110	-	51240KK[1]2[2]0			
	1.5					120.0	6.7	-	13	-	110	-	51540KK[1]2[2]0			
	1.8	15.0 x 25.0 x 31.0				144.0	7.8	-	11	-	120	-	51840KK[1]2[2]0			
	2.2					176.0	9.0	-	10	-	125	-	52240KK[1]2[2]0			
	2.7	18.0 x 28.0 x 31.0				216.0	9.8	-	8	-	140	-	52740KK[1]2[2]0			
	3.3					264.0	11.6	-	7	-	150	-	53340KK[1]2[2]0			
	3.9	21.0 x 31.0 x 31.0				312.0	12.2	-	6	-	160	-	53940KK[1]2[2]0			
	3.3					15.7 x 28.5 x 41.5	148.5	10.7	-	7	-	190	-	53340KP[1]2T0		
	3.9	18.0 x 32.5 x 41.5					175.5	11.2	-	7	-	200	-	53940KP[1]2T0		
	4.7		21.5 x 38.5 x 42.0	211.5	12.7	-	6	-	225	-	54740KP[1]2T0					
	5.6	24.0 x 44.0 x 42.0		252.0	13.2	-	6	-	245	-	55640KP[1]2T0					
	6.8		30.0 x 45.0 x 42.0	306.0	15.3	16.0	5	5	285	260	56840KP[1]4T0					
8.2	369.0	15.6		16.4	5	5	325	295	58240KP[1]4T0							
10		450.0	16.9	17.7	5	5	390	355	61040KP[1]4T0							
12	540.0		18.1	19.0	5	5	465	420	61240KP[1]5T0							
15		675.0	17.9	18.8	5	5	595	540	61540KP[1]5T0							

Notes

- (1) I_{RMS} at 85 °C ambient temperature and 100 kHz
- (2) ESR at 85 °C and 100 kHz
- (3) Maximum tan δ value at 100 kHz
- (4) Please replace "[1]" by the lead length code and the "[2]" by the packaging type in accordance with section "Composition of Catalog Number"



ELECTRICAL DATA AND ORDERING CODE

U _{RDC} (V)	CAP. (μF)	DIMENSION w x h x l (mm)	P1 (mm)	P2 (mm)	du/dt (V/μs) _R	I _{PEAK} (A)	I _{RMS} ⁽¹⁾ (A)		ESR ⁽²⁾ (mΩ)		tan δ ⁽³⁾ (10 ⁻⁴)		ORDERING CODE ⁽⁴⁾ MKP385e....			
							2 PINS	4 PINS	2 PINS	4 PINS	2 PINS	4 PINS				
							U _{RAC} = 220 V, U _{p-p} = 620 V, C-TOL. = ± 10 %									
630	0.027	7.0 x 13.5 x 17.5	15	-	150	3.5	1.4	-	106	-	30	-	32763KF[1]2[2]0			
	0.033					4.3	1.5	-	87	-	30	-	33363KF[1]2[2]0			
	0.039					5.1	1.7	-	74	-	30	-	33963KF[1]2[2]0			
	0.047					6.1	1.8	-	62	-	30	-	34763KF[1]2[2]0			
	0.056					7.3	1.8	-	62	-	35	-	35663KF[1]2[2]0			
	0.068					8.8	2.0	-	51	-	35	-	36863KF[1]2[2]0			
	0.082	8.5 x 15.0 x 17.5				10.7	2.4	-	43	-	40	-	38263KF[1]2[2]0			
	0.10					13.0	2.6	-	35	-	40	-	41063KF[1]2[2]0			
	0.12					15.6	2.9	-	30	-	45	-	41263KF[1]2[2]0			
	0.15	10.0 x 16.5 x 17.5				19.5	3.4	-	24	-	45	-	41563KF[1]2[2]0			
	0.18					23.4	3.7	-	20	-	50	-	41863KF[1]2[2]0			
	0.22	10.5 x 17.5 x 18.0				28.6	4.3	-	17	-	60	-	42263KF[1]2[2]0			
	0.27	11.0 x 18.5 x 18.0	35.1	4.9	-	14	-	65	-	42763KF[1]2[2]0						
	0.12	7.0 x 16.5 x 26.0	22.5	-	130	18.0	2.6	-	48	-	40	-	41263KI[1]2[2]0			
	0.15					22.5	2.9	-	39	-	45	-	41563KI[1]2[2]0			
	0.18	8.5 x 18.0 x 26.0				27.0	3.4	-	32	-	45	-	41863KI[1]2[2]0			
	0.22					33.0	3.8	-	27	-	65	-	42263KI[1]2[2]0			
	0.27	10.0 x 19.5 x 26.0				40.5	4.5	-	22	-	70	-	42763KI[1]2[2]0			
	0.33					49.5	4.9	-	18	-	70	-	43363KI[1]2[2]0			
	0.39	12.0 x 22.0 x 26.0				58.5	5.8	-	15	-	75	-	43963KI[1]2[2]0			
	0.47					70.5	6.3	-	13	-	75	-	44763KI[1]2[2]0			
	0.56					84.0	6.9	-	11	-	80	-	45663KI[1]2[2]0			
	0.27	9.0 x 19.0 x 31.0				27.5	-	90	24.3	3.6	-	34	-	70	-	42763KK[1]2[2]0
	0.33								29.7	3.9	-	28	-	70	-	43363KK[1]2[2]0
	0.39	11.0 x 21.0 x 31.0							35.1	4.6	-	24	-	75	-	43963KK[1]2[2]0
	0.47		42.3	5.1	-				20	-	75	-	44763KK[1]2[2]0			
	0.56		50.4	5.5	-				17	-	80	-	45663KK[1]2[2]0			
	0.68	13.0 x 23.0 x 31.0	61.2	6.5	-				14	-	85	-	46863KK[1]2[2]0			
	0.82		73.8	7.1	-				12	-	90	-	48263KK[1]2[2]0			
	1.0		90.0	8.3	-				10	-	95	-	51063KK[1]2[2]0			
	1.2	18.0 x 28.0 x 31.0	108.0	9.9	-				8	-	100	-	51263KK[1]2[2]0			
	1.5		135.0	10.9	-				7	-	105	-	51563KK[1]2[2]0			
	1.8	21.0 x 31.0 x 31.0	162.0	12.8	-				6	-	110	-	51863KK[1]2[2]0			
	2.2		198.0	14.0	-				5	-	120	-	52263KK[1]2[2]0			
	2.7		18 x 32.5 x 41.5	135.0	11.7	-	7	-	150	-	52763KP[1]2T0					
	3.3	18.5 x 35.5 x 43	37.5	10.2	50	165.0	12.1	12.7	7	7	190	175	53363KP[1]4T0			
	3.9					195.0	12.9	13.6	7	7	225	205	53963KP[1]4T0			
	4.7	21.5 x 38.5 x 42				235.0	13.0	13.7	7	7	270	245	54763KP[1]4T0			
	5.6					280.0	14.3	15.0	7	7	305	275	55663KP[1]4T0			
	6.8	30 x 45 x 42				340.0	16.0	16.7	6	6	340	310	56863KP[1]5T0			
	8.2					410.0	17.0	17.8	6	6	365	330	58263KP[1]5T0			
	15	35 x 50 x 57.5	52.5	20.3	25	375.0	17.6	18.4	7	7	840	760	61563KY[1]5T0			

Notes

- (1) I_{RMS} at 85 °C ambient temperature and 100 kHz
- (2) ESR at 85 °C and 100 kHz
- (3) Maximum tan δ value at 100 kHz
- (4) Please replace "[1]" by the lead length code and the "[2]" by the packaging type in accordance with section "Composition of Catalog Number"



ELECTRICAL DATA AND ORDERING CODE													
U _{RDC} (V)	CAP. (µF)	DIMENSION w x h x l (mm)	P1 (mm)	P2 (mm)	du/dt (V/µs) _R	I _{PEAK} (A)	I _{RMS} ⁽¹⁾ (A)		ESR ⁽²⁾ (mΩ)		tan δ ⁽³⁾ (10 ⁻⁴)		ORDERING CODE ⁽⁴⁾ MKP385e....
							2 PINS	4 PINS	2 PINS	4 PINS	2 PINS	4 PINS	
U_{RAC} = 300 V, U_{p-p} = 850 V, C-TOL. = ± 10 %													
850	0.010	7.0 x 13.5 x 17.5	15	-	590	5.9	1.2	-	154	-	25	-	31085KF[1]2[2]0
	0.012					7.1	1.2	-	147	-	25	-	31285KF[1]2[2]0
	0.015					8.9	1.3	-	118	-	25	-	31585KF[1]2[2]0
	0.018					10.6	1.4	-	107	-	25	-	31885KF[1]2[2]0
	0.022					13.0	1.5	-	88	-	25	-	32285KF[1]2[2]0
	0.027					15.9	1.6	-	79	-	30	-	32785KF[1]2[2]0
	0.033					19.5	1.7	-	74	-	30	-	33385KF[1]2[2]0
	0.039					23.0	1.8	-	63	-	30	-	33985KF[1]2[2]0
	0.047					27.7	2.0	-	59	-	35	-	34785KF[1]2[2]0
	0.056					8.5 x 15.0 x 17.5	22.5	-	530	33.0	2.2	-	50
	0.068	40.1	2.4	-	41					-	35	-	36885KF[1]2[2]0
	0.082	10.0 x 16.5 x 17.5	27.5	-	330	48.4	2.9	-	34	-	40	-	38285KF[1]2[2]0
	0.10					59.0	3.2	-	28	-	40	-	41085KF[1]2[2]0
	0.12	10.5 x 17.5 x 18.0	37.5	-	150	70.8	3.6	-	24	-	40	-	41285KF[1]2[2]0
	0.033	7.0 x 16.5 x 26.0	22.5	-	590	17.5	1.8	-	103	-	30	-	33385KI[1]2[2]0
	0.039					20.7	1.8	-	98	-	30	-	33985KI[1]2[2]0
	0.047					24.9	2.0	-	82	-	30	-	34785KI[1]2[2]0
	0.056					29.7	2.2	-	79	-	35	-	35685KI[1]2[2]0
	0.068					36.0	2.4	-	65	-	35	-	36885KI[1]2[2]0
	0.082					43.5	2.4	-	63	-	40	-	38285KI[1]2[2]0
	0.10					53.0	2.4	-	64	-	45	-	41085KI[1]2[2]0
	0.12					63.6	2.7	-	53	-	45	-	41285KI[1]2[2]0
	0.15					79.5	3.2	-	43	-	50	-	41585KI[1]2[2]0
	0.18					95.4	3.5	-	36	-	55	-	41885KI[1]2[2]0
	0.22	116.6	4.2	-	30	-	60	-	42285KI[1]2[2]0				
	0.27	143.1	4.6	-	24	-	65	-	42785KI[1]2[2]0				
	0.33	174.9	5.1	-	20	-	70	-	43385KI[1]2[2]0				
	0.10	9.0 x 19.0 x 31.0	27.5	-	330	33.0	2.6	-	67	-	40	-	41085KK[1]2[2]0
	0.12	11.0 x 21.0 x 31.0	37.5	-	150	39.6	3.0	-	55	-	40	-	41285KK[1]2[2]0
	0.15					49.5	3.4	-	44	-	45	-	41585KK[1]2[2]0
	0.18					59.4	3.5	-	43	-	50	-	41885KK[1]2[2]0
	0.22					72.6	3.5	-	41	-	60	-	42285KK[1]2[2]0
	0.27					89.1	3.9	-	34	-	65	-	42785KK[1]2[2]0
	0.33					108.9	3.8	-	36	-	75	-	43385KK[1]2[2]0
	0.39					128.7	4.4	-	31	-	75	-	43985KK[1]2[2]0
	0.47					155.1	4.8	-	26	-	75	-	44785KK[1]2[2]0
	0.56					184.8	5.6	-	22	-	85	-	45685KK[1]2[2]0
	0.68					224.4	6.1	-	19	-	95	-	46885KK[1]2[2]0
	0.82	270.6	7.3	-	15	-	100	-	48285KK[1]2[2]0				
	1.0	330.0	8.6	-	13	-	105	-	51085KK[1]2[2]0				
	1.2	396.0	9.4	-	11	-	110	-	51285KK[1]2[2]0				
	1.5	15.7 x 28.5 x 41.5	37.5	-	150	225.0	11.4	-	6	-	75	-	51585KP[1]2T0
1.7	18 x 32.5 x 41.5	20.3	-	150	255.0	12.5	-	6	-	85	-	51785KP[1]2T0	
1.8					270.0	12.6	-	6	-	90	-	51885KP[1]2T0	
2.2	18.5 x 35.5 x 43	37.5	-	150	330.0	13.5	14.2	6	6	105	95	52285KP[1]4T0	
2.7	21.5 x 38.5 x 42	10.2	-	150	405.0	14.8	15.5	6	6	120	110	52785KP[1]4T0	
3.3	24 x 44 x 42	20.3	-	150	495.0	16.1	17.0	5	5	140	130	53385KP[1]4T0	
3.9					585.0	16.5	17.3	5	5	160	145	53985KP[1]4T0	
4.7					705.0	18.1	19.0	5	5	185	170	54785KP[1]5T0	

Notes

- (1) I_{RMS} at 85 °C ambient temperature and 100 kHz
- (2) ESR at 85 °C and 100 kHz
- (3) Maximum tan δ value at 100 kHz
- (4) Please replace "[1]" by the lead length code and the "[2]" by the packaging type in accordance with section "Composition of Catalog Number"



ELECTRICAL DATA AND ORDERING CODE														
U _{RDC} (V)	CAP. (μF)	DIMENSION w x h x l (mm)	P1 (mm)	P2 (mm)	du/dt (V/μs) _R	I _{PEAK} (A)	I _{RMS} ⁽¹⁾ (A)		ESR ⁽²⁾ (mΩ)		tan δ ⁽³⁾ (10 ⁻⁴)		ORDERING CODE ⁽⁴⁾ MKP385e....	
							2 PINS	4 PINS	2 PINS	4 PINS	2 PINS	4 PINS		
U_{RAC} = 350 V, U_{p-p} = 1000 V, C-TOL. = ± 10 %														
1000	0.018	7.0 x 13.5 x 17.5	15	-	590	10.6	1.8	-	66	-	20	-	31810KF[1]2[2]0	
	0.022					13.0	1.9	-	59	-	20	-	32210KF[1]2[2]0	
	0.027					15.9	1.9	-	54	-	25	-	32710KF[1]2[2]0	
	0.033	8.5 x 15.0 x 17.5				19.5	2.3	-	47	-	25	-	33310KF[1]2[2]0	
	0.039					23.0	2.3	-	45	-	30	-	33910KF[1]2[2]0	
	0.047					27.7	2.3	-	44	-	30	-	34710KF[1]2[2]0	
	0.056	10.0 x 16.5 x 17.5				33.0	2.8	-	37	-	35	-	35610KF[1]2[2]0	
	0.068					40.1	2.8	-	35	-	40	-	36810KF[1]2[2]0	
	0.082	10.5 x 17.5 x 18.0				48.4	3.3	-	29	-	45	-	38210KF[1]2[2]0	
	0.056	7.0 x 16.5 x 26.0	22.5	-	530	29.7	2.1	-	72	-	30	-	35610KI[1]2[2]0	
	0.068	8.5 x 18.0 x 26.0				36.0	2.4	-	64	-	35	-	36810KI[1]2[2]0	
	0.082					43.5	2.7	-	53	-	40	-	38210KI[1]2[2]0	
	0.10	10.0 x 19.5 x 26.0				53.0	3.1	-	44	-	40	-	41010KI[1]2[2]0	
	0.12					63.6	3.4	-	37	-	45	-	41210KI[1]2[2]0	
	0.15					79.5	4.2	-	30	-	45	-	41510KI[1]2[2]0	
	0.18	12.0 x 22.0 x 26.0				95.4	4.3	-	27	-	50	-	41810KI[1]2[2]0	
	0.22					116.6	4.6	-	24	-	65	-	42210KI[1]2[2]0	
	0.10	9.0 x 19.0 x 31.0				27.5	-	330	33.0	2.7	-	60	-	45
	0.12		39.6	2.8	-				58	-	45	-	41210KK[1]2[2]0	
	0.15	49.5	3.3	-	47				-	50	-	41510KK[1]2[2]0		
	0.18	11.0 x 21.0 x 31.0	59.4	3.6	-				39	-	50	-	41810KK[1]2[2]0	
	0.22		72.6	3.8	-				35	-	70	-	42210KK[1]2[2]0	
	0.27	13.0 x 23.0 x 31.0	89.1	4.5	-				29	-	70	-	42710KK[1]2[2]0	
	0.33		108.9	4.8	-				26	-	75	-	43310KK[1]2[2]0	
	0.39	15.0 x 25.0 x 31.0	128.7	5.5	-				22	-	75	-	43910KK[1]2[2]0	
	0.47		155.1	5.7	-				21	-	80	-	44710KK[1]2[2]0	
	0.56	18.0 x 28.0 x 31.0	184.8	6.6	-	19	-	95	-	45610KK[1]2[2]0				
	0.68	21.0 x 31.0 x 31.0	224.4	7.8	-	16	-	100	-	46810KK[1]2[2]0				
	0.82		270.6	8.3	-	14	-	105	-	48210KK[1]2[2]0				
	1.0	15.7 x 28.5 x 41.5	37.5	-	180	180.0	10.5	-	7	-	60	-	51010KP[1]2T0	
1.2	18 x 32.5 x 41.5	216.0				11.9	-	7	-	65	-	51210KP[1]2T0		
1.5	18.5 x 35.5 x 43	270.0				13.3	14.0	6	6	75	70	51510KP[1]4T0		
1.8	21.5 x 38.5 x 42	324.0		14.7		15.5	6	6	80	75	51810KP[1]4T0			
2.2		24 x 44 x 42		396.0		16.4	17.3	5	5	90	85	52210KP[1]4T0		
2.7	486.0			17.0		17.8	5	5	105	95	52710KP[1]4T0			
3.3	594.0			18.7		19.6	5	5	120	110	53310KP[1]5T0			
	30 x 45 x 42			20.3										

Notes

- (1) I_{RMS} at 85 °C ambient temperature and 100 kHz
- (2) ESR at 85 °C and 100 kHz
- (3) Maximum tan δ value at 100 kHz
- (4) Please replace "[1]" by the lead length code and the "[2]" by the packaging type in accordance with section "Composition of Catalog Number"



ELECTRICAL DATA AND ORDERING CODE																
U _{RDC} (V)	CAP. (μF)	DIMENSION w x h x l (mm)	P1 (mm)	P2 (mm)	du/dt (V/μs) _R	I _{PEAK} (A)	I _{RMS} ⁽¹⁾ (A)		ESR ⁽²⁾ (mΩ)		tan δ ⁽³⁾ (10 ⁻⁴)		ORDERING CODE ⁽⁴⁾ MKP385e....			
							2 PINS	4 PINS	2 PINS	4 PINS	2 PINS	4 PINS				
U_{RAC} = 450 V, U_{p-p} = 1250 V, C-TOL. = ± 10 %																
1250	0.0082	7.0 x 13.5 x 17.5	15	-	670	5.5	1.7	-	71	-	20	-	28212KF[1]2[2]0			
	0.010					6.7	1.8	-	64	-	20	-	31012KF[1]2[2]0			
	0.012					8.0	1.9	-	60	-	20	-	31212KF[1]2[2]0			
	0.015					10.1	2.0	-	51	-	25	-	31512KF[1]2[2]0			
	0.018					12.1	2.2	-	43	-	25	-	31812KF[1]2[2]0			
	0.022	8.5 x 15.0 x 17.5				14.7	2.6	-	35	-	25	-	32212KF[1]2[2]0			
	0.027					18.1	2.9	-	29	-	25	-	32712KF[1]2[2]0			
	0.033					22.1	3.2	-	24	-	30	-	33312KF[1]2[2]0			
	0.039					10.0 x 16.5 x 17.5	26.1	3.7	-	20	-	30	-	33912KF[1]2[2]0		
	0.047						31.5	4.1	-	17	-	30	-	34712KF[1]2[2]0		
	0.056	10.5 x 17.5 x 18.0				37.5	4.7	-	14	-	35	-	35612KF[1]2[2]0			
	0.068	11.0 x 18.5 x 18.0				45.6	5.3	-	12	-	35	-	36812KF[1]2[2]0			
	0.047	8.5 x 18.0 x 26.0				22.5	-	600	28.2	3.2	-	37	-	30	-	34712KI[1]2[2]0
	0.056								33.6	3.5	-	32	-	30	-	35612KI[1]2[2]0
	0.068								40.8	3.8	-	26	-	35	-	36812KI[1]2[2]0
	0.082		10.0 x 19.5 x 26.0	49.2	4.5				-	22	-	40	-	38212KI[1]2[2]0		
	0.10			60.0	4.9				-	18	-	40	-	41012KI[1]2[2]0		
	0.12	12.0 x 22.0 x 26.0	72.0	5.9	-				15	-	45	-	41212KI[1]2[2]0			
	0.15		90.0	6.5	-				12	-	45	-	41512KI[1]2[2]0			
	0.18		108.0	7.3	-				10	-	45	-	41812KI[1]2[2]0			
	0.10	9.0 x 19.0 x 31.0	27.5	-	370				37.0	4.7	-	20	-	45	-	41012KK[1]2[2]0
	0.12	11.0 x 21.0 x 31.0							44.4	5.6	-	17	-	45	-	41212KK[1]2[2]0
	0.15								55.5	6.2	-	13	-	45	-	41512KK[1]2[2]0
	0.18	13.0 x 23.0 x 31.0							66.6	7.3	-	11	-	50	-	41812KK[1]2[2]0
	0.22								81.4	8.0	-	9	-	65	-	42212KK[1]2[2]0
	0.27								99.9	9.4	-	8	-	65	-	42712KK[1]2[2]0
	0.33	15.0 x 25.0 x 31.0							122.1	10.2	-	6	-	70	-	43312KK[1]2[2]0
	0.39					144.3	12.1	-	6	-	70	-	43912KK[1]2[2]0			
	0.47	18.0 x 28.0 x 31.0				173.9	13.1	-	5	-	75	-	44712KK[1]2[2]0			
	0.56					207.2	15.3	-	4	-	80	-	45612KK[1]2[2]0			
	0.68					15.7 x 28.5 x 41.5	136.0	15.8	-	3	-	20	-	46812KP[1]2T0		
	0.82	18 x 32.5 x 41.5				164.0	14.4	-	5	-	30	-	48212KP[1]2T0			
	1.0					200.0	13.2	-	6	-	45	-	51012KP[1]2T0			
	1.2	18.5 x 35.5 x 43				37.5	10.2	200	240.0	13.3	13.9	6	6	60	55	51212KP[1]4T0
	1.5	21.5 x 38.5 x 42							300.0	14.1	14.8	6	6	75	70	51512KP[1]4T0
	1.8	24 x 44 x 42	360.0	15.7	16.4				6	6	85	80	51812KP[1]4T0			
	2.2	30 x 45 x 42	440.0	18.1	19.1				5	5	85	80	52212KP[1]5T0			
	2.7		540.0	18.5	19.5				5	5	100	90	52712KP[1]5T0			

Notes

- (1) I_{RMS} at 85 °C ambient temperature and 100 kHz
- (2) ESR at 85 °C and 100 kHz
- (3) Maximum tan δ value at 100 kHz
- (4) Please replace "[1]" by the lead length code and the "[2]" by the packaging type in accordance with section "Composition of Catalog Number"



ELECTRICAL DATA AND ORDERING CODE														
U _{RDC} (V)	CAP. (μF)	DIMENSION w x h x l (mm)	P1 (mm)	P2 (mm)	du/dt (V/μs) _R	I _{PEAK} (A)	I _{RMS} ⁽¹⁾ (A)		ESR ⁽²⁾ (mΩ)		tan δ ⁽³⁾ (10 ⁻⁴)		ORDERING CODE ⁽⁴⁾ MKP385e....	
							2 PINS	4 PINS	2 PINS	4 PINS	2 PINS	4 PINS		
U_{RAC} = 550 V, U_{p-p} = 1600 V, C-TOL. = ± 10 %														
1600	0.0039	7.0 x 13.5 x 17.5	15	-	2000	7.8	1.2	-	139	-	20	-	2391AKF[1]2[2]0	
	0.0047					9.4	1.3	-	116	-	20	-	2471AKF[1]2[2]0	
	0.0056					11.2	1.4	-	102	-	20	-	2561AKF[1]2[2]0	
	0.0068					13.6	1.6	-	85	-	20	-	2681AKF[1]2[2]0	
	0.0082					16.4	1.7	-	73	-	20	-	2821AKF[1]2[2]0	
	0.010					20.0	1.8	-	63	-	25	-	3101AKF[1]2[2]0	
	0.012					24.0	2.0	-	53	-	25	-	3121AKF[1]2[2]0	
	0.015					8.5 x 15.0 x 17.5	30.0	2.4	-	42	-	25	-	3151AKF[1]2[2]0
	0.018						36.0	2.7	-	35	-	25	-	3181AKF[1]2[2]0
	0.022					10.0 x 16.5 x 17.5	44.0	3.2	-	29	-	25	-	3221AKF[1]2[2]0
	0.027	54.0	3.5	-	24		-	30	-	3271AKF[1]2[2]0				
	0.033	10.5 x 17.5 x 18.0	66.0	4.0	-	20	-	30	-	3331AKF[1]2[2]0				
	0.039	11.0 x 18.5 x 18.0	78.0	4.4	-	17	-	30	-	3391AKF[1]2[2]0				
	0.010	7.0 x 16.5 x 26.0	22.5	-	1700	17.0	2.1	-	73	-	25	-	3101AKI[1]2[2]0	
	0.012					20.4	2.5	-	60	-	25	-	3121AKI[1]2[2]0	
	0.015					25.5	2.6	-	55	-	25	-	3151AKI[1]2[2]0	
	0.018					30.6	2.9	-	46	-	25	-	3181AKI[1]2[2]0	
	0.022					37.4	3.1	-	41	-	25	-	3221AKI[1]2[2]0	
	0.027					45.9	3.4	-	33	-	30	-	3271AKI[1]2[2]0	
	0.033					56.1	3.5	-	30	-	30	-	3331AKI[1]2[2]0	
	0.039					66.3	3.8	-	26	-	30	-	3391AKI[1]2[2]0	
	0.047					10.0 x 19.5 x 26.0	79.9	4.5	-	21	-	30	-	3471AKI[1]2[2]0
	0.056						95.2	4.9	-	18	-	35	-	3561AKI[1]2[2]0
	0.068	12.0 x 22.0 x 26.0	115.6	5.9	-	15	-	35	-	3681AKI[1]2[2]0				
	0.082		139.4	6.4	-	13	-	40	-	3821AKI[1]2[2]0				
	0.10		170.0	7.0	-	11	-	40	-	4101AKI[1]2[2]0				
	0.068		81.6	5.1	-	20	-	40	-	3681AKK[1]2[2]0				
	0.082	11.0 x 21.0 x 31.0	98.4	5.6	-	16	-	40	-	3821AKK[1]2[2]0				
	0.10		120.0	6.1	-	14	-	45	-	4101AKK[1]2[2]0				
	0.12	13.0 x 23.0 x 31.0	144.0	7.2	-	11	-	45	-	4121AKK[1]2[2]0				
	0.15	15.0 x 25.0 x 31.0	180.0	8.6	-	9	-	45	-	4151AKK[1]2[2]0				
	0.18		216.0	9.3	-	8	-	50	-	4181AKK[1]2[2]0				
	0.22	18.0 x 28.0 x 31.0	264.0	11.2	-	7	-	60	-	4221AKK[1]2[2]0				
	0.27		324.0	12.2	-	5	-	65	-	4271AKK[1]2[2]0				
	0.33	21.0 x 31.0 x 31.0	396.0	14.4	-	5	-	70	-	4331AKK[1]2[2]0				
	0.39	18 x 32.5 x 41.5	175.5	11.2	-	8	-	25	-	4391AKP[1]2T0				
0.47	211.5		12.2	-	6	-	25	-	4471AKP[1]2T0					
0.56	18.5 x 35.5 x 43	252.0	13.7	14.4	6	6	25	25	4561AKP[1]4T0					
0.68	21.5 x 38.5 x 42	306.0	15.4	16.2	5	5	30	30	4681AKP[1]4T0					
0.82		369.0	17.0	17.9	5	5	35	35	4821AKP[1]4T0					
1.00	24 x 44 x 42	450.0	17.2	18.0	5	5	40	40	5101AKP[1]4T0					
1.20		540.0	18.2	19.1	5	5	50	45	5121AKP[1]5T0					

Notes

- (1) I_{RMS} at 85 °C ambient temperature and 100 kHz
- (2) ESR at 85 °C and 100 kHz
- (3) Maximum tan δ value at 100 kHz
- (4) Please replace "[1]" by the lead length code and the "[2]" by the packaging type in accordance with section "Composition of Catalog Number"



ELECTRICAL DATA AND ORDERING CODE													
U _{RDC} (V)	CAP. (μF)	DIMENSION w x h x l (mm)	P1 (mm)	P2 (mm)	du/dt (V/μs) _R	I _{PEAK} (A)	I _{RMS} ⁽¹⁾ (A)		ESR ⁽²⁾ (mΩ)		tan δ ⁽³⁾ (10 ⁻⁴)		ORDERING CODE ⁽⁴⁾ MKP385e....
							2 PINS	4 PINS	2 PINS	4 PINS	2 PINS	4 PINS	
U_{RAC} = 700 V, U_{p-p} = 2000 V, C-TOL. = ± 10 %													
2000	0.0010	7.0 x 13.5 x 17.5	15	-	2900	2.9	0.7	-	420	-	20	-	2102AKF[1]2[2]0
	0.0012					3.5	0.8	-	351	-	20	-	2122AKF[1]2[2]0
	0.0015					4.4	0.9	-	281	-	20	-	2152AKF[1]2[2]0
	0.0018					5.2	0.9	-	234	-	20	-	2182AKF[1]2[2]0
	0.0022					6.4	1.0	-	200	-	20	-	2222AKF[1]2[2]0
	0.0027					7.8	1.1	-	163	-	20	-	2272AKF[1]2[2]0
	0.0033					9.6	1.2	-	139	-	25	-	2332AKF[1]2[2]0
	0.0039					11.3	1.3	-	118	-	25	-	2392AKF[1]2[2]0
	0.0047					13.6	1.4	-	98	-	25	-	2472AKF[1]2[2]0
	0.0056					16.2	1.5	-	87	-	25	-	2562AKF[1]2[2]0
	0.0068	8.5 x 15.0 x 17.5	22.5	-	2500	19.7	1.8	-	72	-	25	-	2682AKF[1]2[2]0
	0.0082					23.8	2.0	-	59	-	25	-	2822AKF[1]2[2]0
	0.010					29.0	2.2	-	49	-	25	-	3102AKF[1]2[2]0
	0.012					34.8	2.6	-	41	-	25	-	3122AKF[1]2[2]0
	0.015					43.5	2.9	-	33	-	25	-	3152AKF[1]2[2]0
	0.018					52.2	3.4	-	28	-	25	-	3182AKF[1]2[2]0
	0.022	63.8	3.8	-	23	-	25	-	3222AKF[1]2[2]0				
	0.010	8.5 x 18.0 x 26.0	22.5	-	2500	25.0	2.3	-	72	-	25	-	3102AKI[1]2[2]0
	0.012					30.0	2.5	-	60	-	25	-	3122AKI[1]2[2]0
	0.015					37.5	2.6	-	55	-	30	-	3152AKI[1]2[2]0
0.018	45.0					2.9	-	46	-	30	-	3182AKI[1]2[2]0	
0.022	55.0					3.2	-	38	-	30	-	3222AKI[1]2[2]0	
0.027	67.5					3.7	-	31	-	30	-	3272AKI[1]2[2]0	
0.033	82.5					4.1	-	26	-	30	-	3332AKI[1]2[2]0	
0.039	97.5					4.9	-	22	-	30	-	3392AKI[1]2[2]0	
0.047	12.0 x 22.0 x 26.0	27.5	-	1700	117.5	5.3	-	18	-	30	-	3472AKI[1]2[2]0	
0.056					140.0	5.8	-	15	-	35	-	3562AKI[1]2[2]0	
0.022	11.0 x 21.0 x 31.0	27.5	-	1700	37.4	3.5	-	42	-	30	-	3222AKK[1]2[2]0	
0.027					45.9	3.9	-	34	-	30	-	3272AKK[1]2[2]0	
0.033					56.1	4.0	-	33	-	30	-	3332AKK[1]2[2]0	
0.039					66.3	4.3	-	28	-	30	-	3392AKK[1]2[2]0	
0.047					79.9	4.7	-	23	-	30	-	3472AKK[1]2[2]0	
0.056					95.2	5.5	-	20	-	35	-	3562AKK[1]2[2]0	
0.068					115.6	6.1	-	16	-	35	-	3682AKK[1]2[2]0	
0.082					139.4	7.1	-	14	-	40	-	3822AKK[1]2[2]0	
0.10					170.0	7.8	-	11	-	40	-	4102AKK[1]2[2]0	
0.12					204.0	9.3	-	9	-	45	-	4122AKK[1]2[2]0	
0.15	255.0	10.3	-	8	-	45	-	4152AKK[1]2[2]0					
0.18	306.0	12.1	-	7	-	45	-	4182AKK[1]2[2]0					
0.22	18.0 x 32.5 x 41.5	37.5	-	600	132.0	11.0	11.6	8	8	15	15	4222AKP[1]4T0	
0.27					162.0	11.2	11.8	8	7	20	20	4272AKP[1]4T0	
0.33					198.0	12.6	13.2	7	7	20	20	4332AKP[1]4T0	
0.39					234.0	14.2	14.9	6	6	20	20	4392AKP[1]4T0	
0.47					282.0	15.6	16.4	6	6	25	25	4472AKP[1]4T0	
0.56					336.0	16.1	17.0	5	5	25	25	4562AKP[1]4T0	
0.68					408.0	17.7	18.6	5	5	30	30	4682AKP[1]5T0	

Notes

- (1) I_{RMS} at 85 °C ambient temperature and 100 kHz
- (2) ESR at 85 °C and 100 kHz
- (3) Maximum tan δ value at 100 kHz
- (4) Please replace "[1]" by the lead length code and the "[2]" by the packaging type in accordance with section "Composition of Catalog Number"



ELECTRICAL DATA AND ORDERING CODE														
U _{RDC} (V)	CAP. (μF)	DIMENSION w x h x l (mm)	P1 (mm)	P2 (mm)	du/dt (V/μs) _R	I _{PEAK} (A)	I _{RMS} ⁽¹⁾ (A)		ESR ⁽²⁾ (mΩ)		tan δ ⁽³⁾ (10 ⁻⁴)		ORDERING CODE ⁽⁴⁾ MKP385e....	
							2 PINS	4 PINS	2 PINS	4 PINS	2 PINS	4 PINS		
U_{RAC} = 800 V, U_{p-p} = 2250 V, C-TOL. = ± 10 %														
2500	0.0010	7.0 x 16.5 x 26.0	22.5	-	2500	2.5	0.8	-	493	-	20	-	2102BKI[1]2[2]0	
	0.0012					3.0	0.9	-	411	-	20	-	2122BKI[1]2[2]0	
	0.0015					8.5 x 18.0 x 26.0	3.8	1.1	-	338	-	20	-	2152BKI[1]2[2]0
	0.0018	4.5					1.2	-	281	-	20	-	2182BKI[1]2[2]0	
	0.0022	5.5					1.3	-	232	-	25	-	2222BKI[1]2[2]0	
	0.0027	6.8					1.3	-	213	-	25	-	2272BKI[1]2[2]0	
	0.0033	8.3					1.5	-	175	-	25	-	2332BKI[1]2[2]0	
	0.0039	9.8					1.5	-	160	-	25	-	2392BKI[1]2[2]0	
	0.0047	11.8					1.7	-	133	-	25	-	2472BKI[1]2[2]0	
	0.0056	14.0					1.8	-	112	-	25	-	2562BKI[1]2[2]0	
	0.0068	10.0 x 19.5 x 26.0					17.0	2.2	-	93	-	25	-	2682BKI[1]2[2]0
	0.0082						20.5	2.4	-	77	-	25	-	2822BKI[1]2[2]0
	0.010					25.0	2.6	-	65	-	25	-	3102BKI[1]2[2]0	
	0.012					30.0	3.1	-	54	-	30	-	3122BKI[1]2[2]0	
	0.015	12.0 x 22.0 x 26.0	37.5	3.5	-	43	-	30	-	3152BKI[1]2[2]0				
	0.018		45.0	3.9	-	37	-	30	-	3182BKI[1]2[2]0				
	0.018	11.0 x 21.0 x 31.0	27.5	-	1700	25.5	2.9	-	60	-	30	-	3152BKK[1]2[2]0	
	0.018					30.6	3.2	-	51	-	30	-	3182BKK[1]2[2]0	
	0.022					13.0 x 23.0 x 31.0	37.4	3.7	-	42	-	30	-	3222BKK[1]2[2]0
	0.027						45.9	4.1	-	35	-	30	-	3272BKK[1]2[2]0
	0.033					15.0 x 25.0 x 31.0	56.1	4.8	-	29	-	30	-	3332BKK[1]2[2]0
	0.039						66.3	5.2	-	25	-	30	-	3392BKK[1]2[2]0
	0.047					18.0 x 28.0 x 31.0	79.9	6.1	-	22	-	30	-	3472BKK[1]2[2]0
	0.056						95.2	6.6	-	19	-	35	-	3562BKK[1]2[2]0
	0.068					21.0 x 31.0 x 31.0	115.6	7.7	-	16	-	35	-	3682BKK[1]2[2]0
	0.082						139.4	8.2	-	14	-	40	-	3822BKK[1]2[2]0
	0.10	15.7 x 28.5 x 41.5	37.5	10.2	1000	100.0	8.0	-	11	-	10	-	4102BKP[1]2T0	
	0.12	18 x 32.5 x 41.5				120.0	9.5	-	10	-	10	-	4122BKP[1]2T0	
0.15	18.5 x 35.5 x 43	150.0				11.2	11.8	8	8	10	10	4152BKP[1]4T0		
0.18	21.5 x 38.5 x 42	180.0				12.4	13.0	8	8	15	15	4182BKP[1]4T0		
0.22		220.0				13.7	14.4	6	6	15	15	4222BKP[1]4T0		
0.27	24 x 44 x 42	270.0				15.5	16.2	6	6	15	15	4272BKP[1]4T0		
0.33	30 x 45 x 42	330.0				17.5	18.3	5	5	15	15	4332BKP[1]5T0		
0.39		390.0				18.2	19.1	5	5	15	15	4392BKP[1]5T0		

Notes

- (1) I_{RMS} at 85 °C ambient temperature and 100 kHz
- (2) ESR at 85 °C and 100 kHz
- (3) Maximum tan δ value at 100 kHz
- (4) Please replace "[1]" by the lead length code and the "[2]" by the packaging type in accordance with section "Composition of Catalog Number"



PACKAGING INFORMATION					
DIMENSIONS ⁽¹⁾ (mm)	MASS ⁽²⁾ (g)	d _t (mm)	SPQ (pcs)		
			LOOSE IN BOX		REEL PACK ⁽³⁾
			l _t ≤ 5 mm	l _t = 25 mm	H = 18.5 mm; P ₀ = 12.7 mm
PITCH = 15 mm ± 0.4 mm					
7.0 x 13.5 x 17.5	1.8	0.80 ± 0.08	750	500	800
8.5 x 15.0 x 17.5	2.4	0.80 ± 0.08	750	500	650
10.0 x 16.5 x 17.5	3	0.80 ± 0.08	500	450	600
10.5 x 17.5 x 18.0	4	0.80 ± 0.08	225	400	600
11.0 x 18.5 x 18.0	5	0.80 ± 0.08	225	350	550
PITCH = 22.5 mm ± 0.4 mm					
7.0 x 16.5 x 26.0	2.9	0.80 ± 0.08	200	250	500
8.5 x 18.0 x 26.0	3.8	0.80 ± 0.08	200	250	450
10.0 x 19.5 x 26.0	6.8	0.80 ± 0.08	200	200	350
12.0 x 22.0 x 26.0	7.8	0.80 ± 0.08	150	200	300
12.5 x 22.5 x 26.5	10	0.80 ± 0.08	140	400	300
PITCH = 27.5 mm ± 0.4 mm					
9.0 x 19.0 x 31.0	5.5	0.80 ± 0.08	100	150	-
11.0 x 21.0 x 31.0	7.4	0.80 ± 0.08	100	125	-
13.0 x 23.0 x 31.0	9.2	0.80 ± 0.08	100	125	-
15.0 x 25.0 x 31.0	12.3	0.80 ± 0.08	100	125	-
18.0 x 28.0 x 31.0	16.1	0.80 ± 0.08	100	100	-
21.0 x 31.0 x 31.0	18.3	0.80 ± 0.08	50	75	-
PITCH = 37.5 mm ± 0.4 mm					
15.7 x 28.5 x 41.5	17.92	0.95 ± 0.10	70	-	-
18.0 x 32.5 x 41.5	23.68	0.95 ± 0.10	60	-	-
18.5 x 35.5 x 43.0	29.41	0.95 ± 0.10	105	-	-
21.5 x 38.5 x 42.0	37.68	0.95 ± 0.10	91	-	-
24.0 x 44.0 x 42.0	47.37	0.95 ± 0.10	77	-	-
30.0 x 45.0 x 42.0	58.82	0.95 ± 0.10	63	-	-
PITCH = 57.5 mm ± 0.4 mm					
35.0 x 50.0 x 57.5	99.0	0.95 ± 0.10	40	-	-

Notes

- SPQ = Standard Packing Quantity
- (1) For tolerances see section "Space Requirements on Printed-Circuit Board"
- (2) Weight for short lead product only
- (3) H = in-tape height; P₀ = sprocket hole distance

MOUNTING**Normal Use**

The capacitors are designed for mounting on printed-circuit boards. The capacitors packed in bandoleers are designed for mounting on printed-circuit boards by means of automatic insertion machines.

For detailed tape specifications refer to packaging information www.vishay.com/doc?28139

Specific Method of Mounting to Withstand Vibration and Shock

In order to withstand vibration and shock tests, it must be ensured that the stand-off pips are in good contact with the printed-circuit board:

- For original pitch = 15 mm the capacitors shall be mechanically fixed by the leads
- For larger pitches the capacitors shall be mounted in the same way and the body clamped

Space Requirements on Printed-Circuit Board

The maximum space for length (l_{max}), width (w_{max}), and height (h_{max}) of film capacitors to take in account on the printed circuit board is shown in the drawings:

For products with pitch ≤ 15 mm, Δw = Δl = 0.3 mm and Δh = 0.1 mm

For products with 15 mm < pitch ≤ 27.5 mm, Δw = Δl = 0.5 mm and Δh = 0.1 mm

For products with pitch = 37.5 mm and 52.5 mm, Δw = Δl = 0.7 mm and Δh = 0.5 mm

Eccentricity defined as in drawing. The maximum eccentricity is smaller than or equal to the lead diameter of the product concerned.

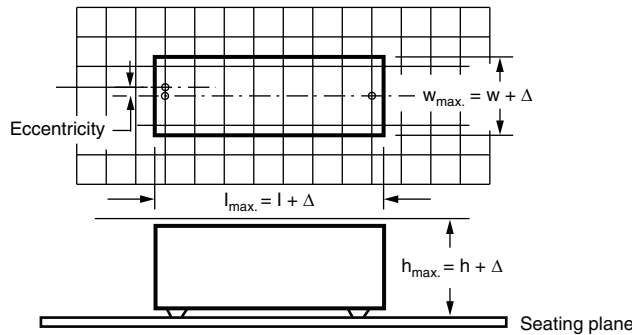

For the minimum product dimensions for length ($l_{min.}$), width ($w_{min.}$), and height ($h_{min.}$) following tolerances of the components are valid:

$l_{min.} = l - \Delta l$, $w_{min.} = w - \Delta w$, and $h_{min.} = h - \Delta h$ following

For products with pitch = 15 mm, $\Delta l = 0.5$ mm and $\Delta w = \Delta h = 0.5$ mm

For products with 15 mm < pitch < 27.5 mm, $\Delta l = 1.0$ mm and $\Delta w = \Delta h = 0.5$ mm

For products with pitch = 27.5 mm, $\Delta w = \Delta l = \Delta h = 1.0$ mm

For products with pitch = 37.5 mm and 52.5 mm. $\Delta w = \Delta l = 0.7$ mm and $\Delta h = 0.5$ mm

SOLDERING CONDITIONS

For general soldering conditions and wave soldering profile we refer to the document “Soldering Conditions Vishay Film Capacitors”: www.vishay.com/doc?28171

STORAGE TEMPERATURE

$T_{stg} = -25$ °C to $+35$ °C with RH maximum 75 % without condensation.

RATINGS AND CHARACTERISTICS REFERENCE CONDITIONS

Unless otherwise specified, all electrical values apply to an ambient free temperature of 23 °C ± 1 °C, an atmospheric pressure of 86 kPa to 106 kPa, and a relative humidity of 50 % ± 2 %.

For reference testing, a conditioning period shall be applied over 96 h ± 4 h by heating the products in a circulating air oven at the rated temperature and a relative humidity not exceeding 20 %.

CHARACTERISTICS

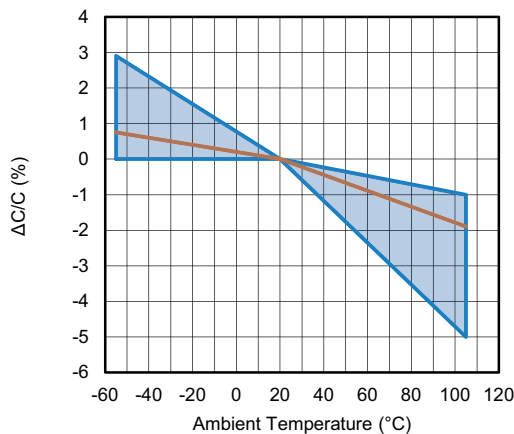

Capacitance as a function of ambient temperature (typical curve) (1 kHz)

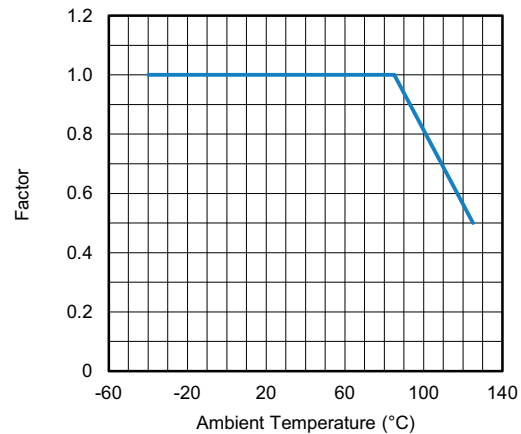

Max. DC and AC voltage as a function of temperature

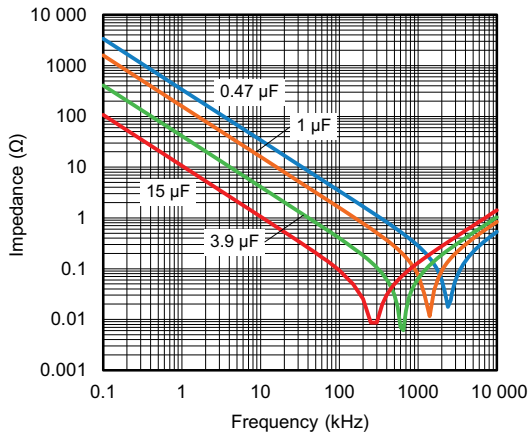

Impedance as a function of frequency (typical curve)

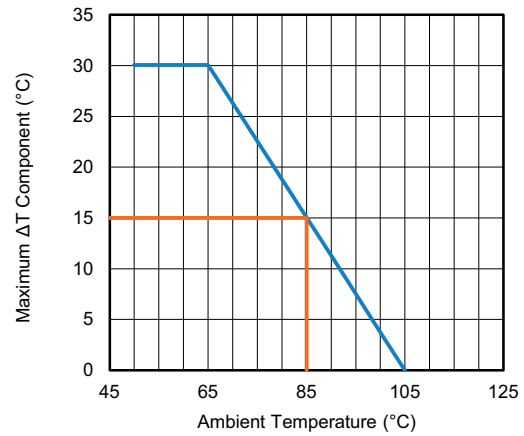

Maximum allowed component temperature rise (ΔT) as a function of ambient temperature (T_{amb})

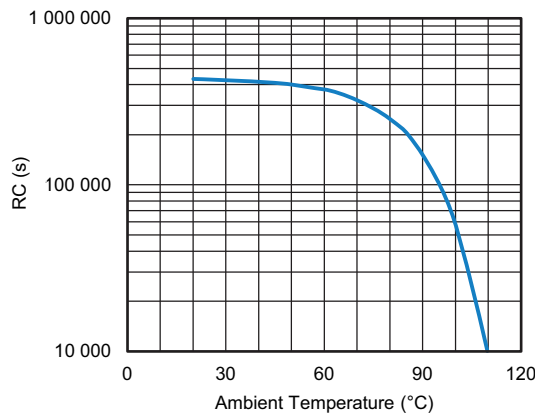

Insulation resistance as a function of ambient temperature (typical curve)

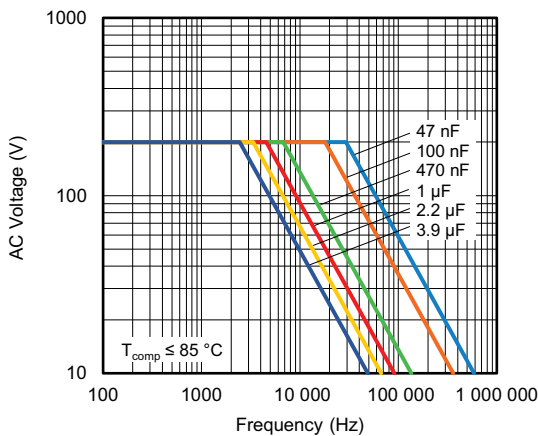

Maximum RMS voltage as a function of frequency (400 V_{DC})

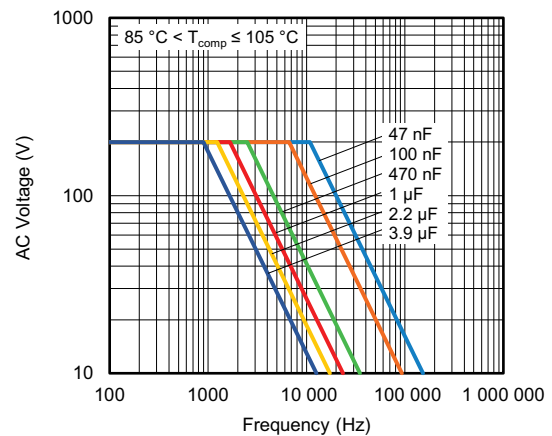

Maximum RMS voltage as a function of frequency (400 V_{DC})

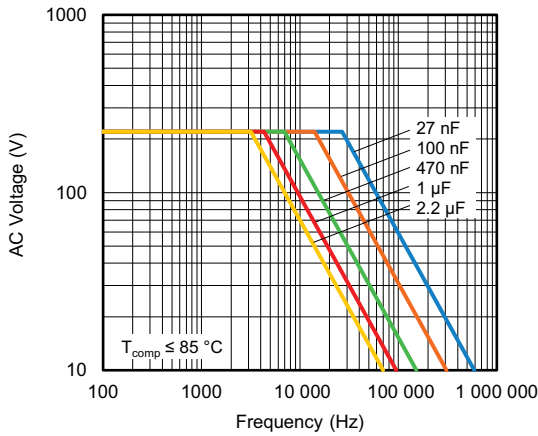

Maximum RMS voltage as a function of frequency (630 V_{DC})

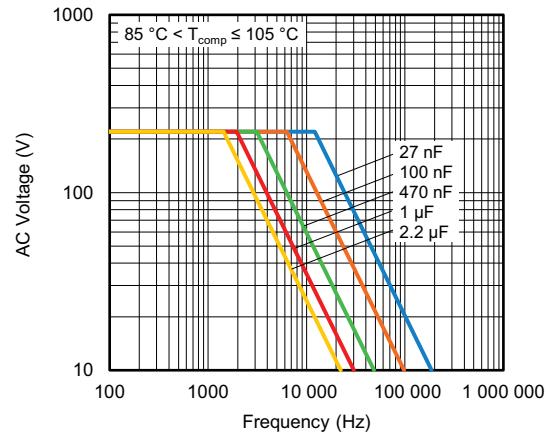

Maximum RMS voltage as a function of frequency (630 V_{DC})

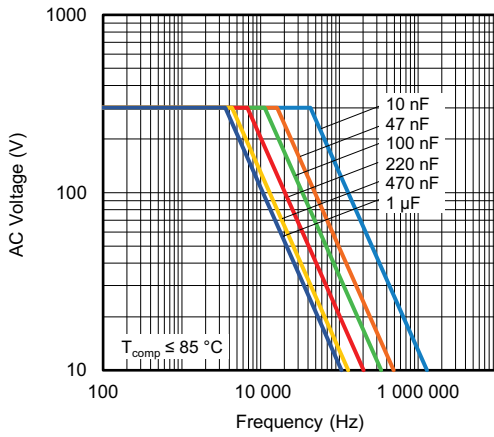

Maximum RMS voltage as a function of frequency (850 V_{DC})

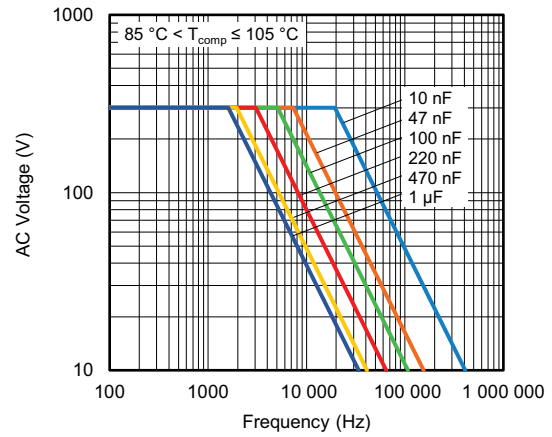

Maximum RMS voltage as a function of frequency (850 V_{DC})

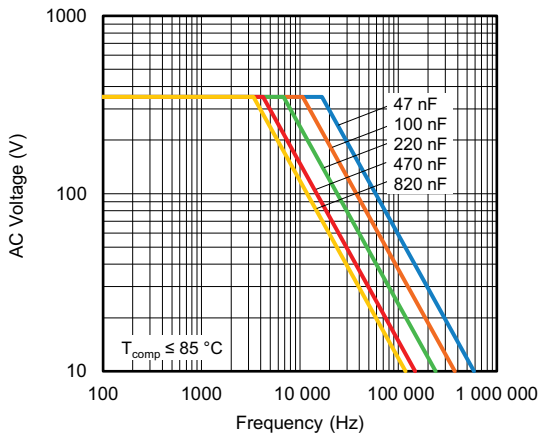

Maximum RMS voltage as a function of frequency (1000 V_{DC})

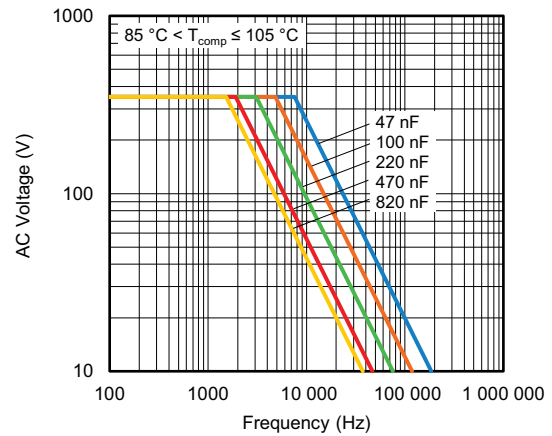

Maximum RMS voltage as a function of frequency (1000 V_{DC})

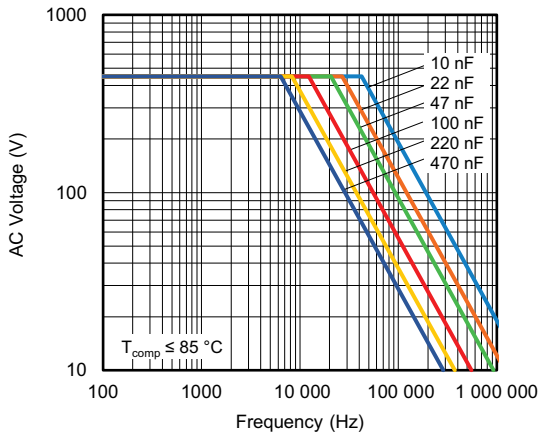

Maximum RMS voltage as a function of frequency (1250 V_{DC})

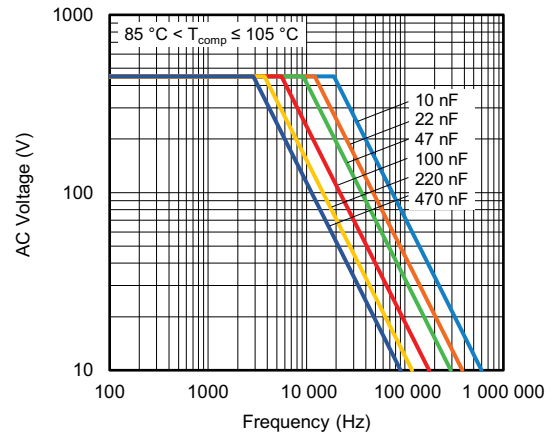

Maximum RMS voltage as a function of frequency (1250 V_{DC})

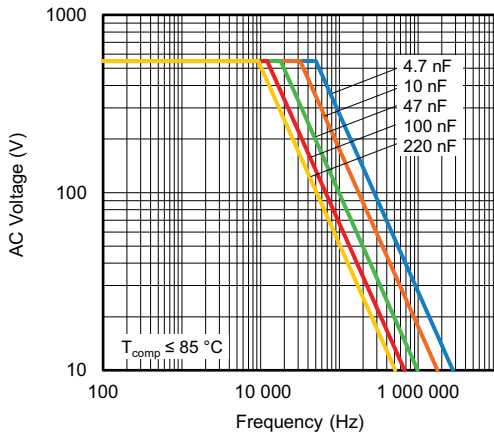

Maximum RMS voltage as a function of frequency (1600 V_{DC})

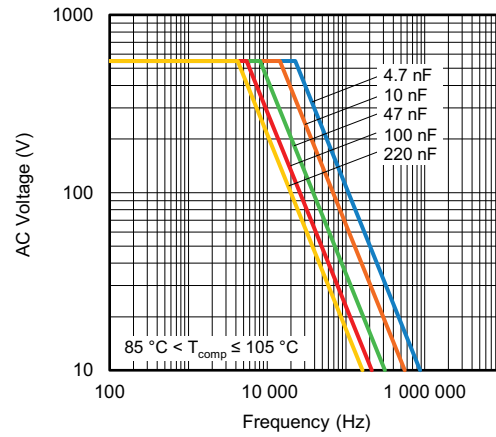

Maximum RMS voltage as a function of frequency (1600 V_{DC})

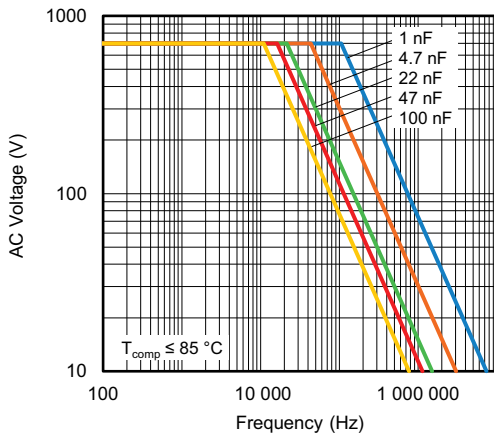

Maximum RMS voltage as a function of frequency (2000 V_{DC})

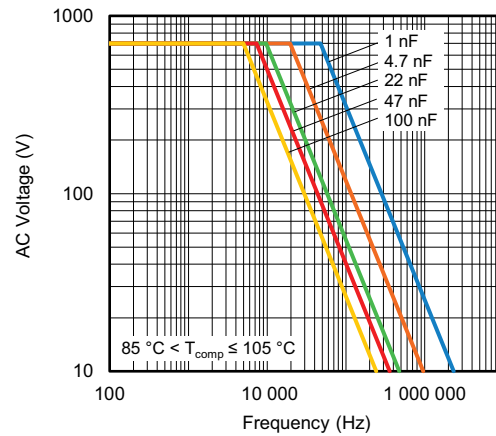

Maximum RMS voltage as a function of frequency (2000 V_{DC})

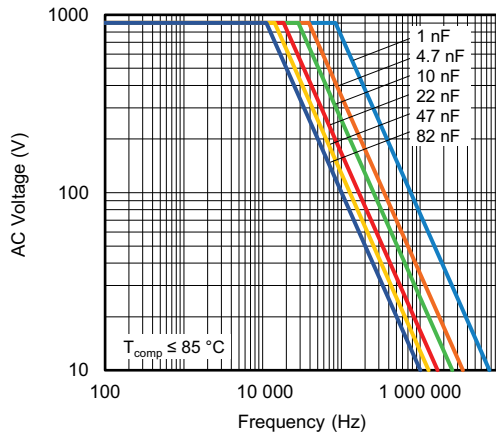

Maximum RMS voltage as a function of frequency (2500 V_{DC})

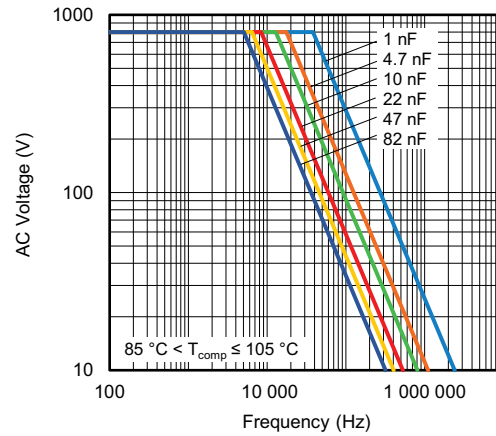

Maximum RMS voltage as a function of frequency (2500 V_{DC})

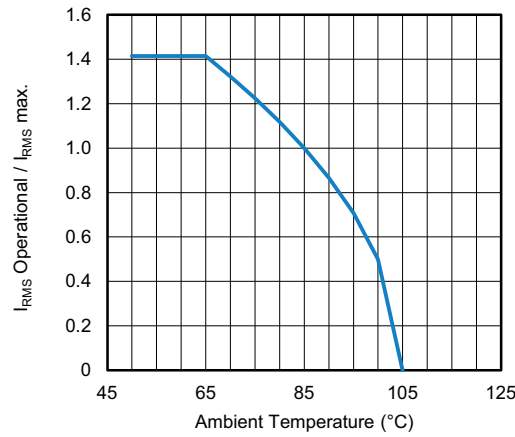

Maximum I_{RMS} current in function of the ambient temperature (typical curve)

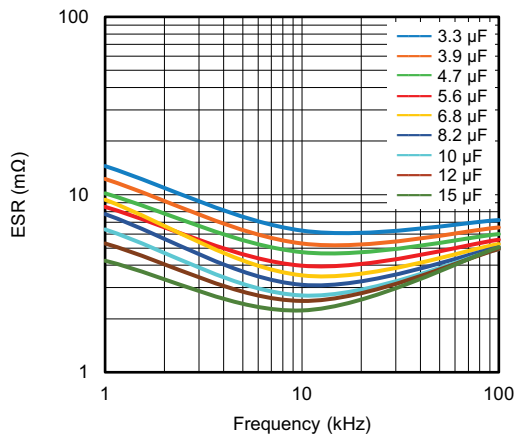

ESR as a function of frequency (400 V_{DC}) (typical curve)

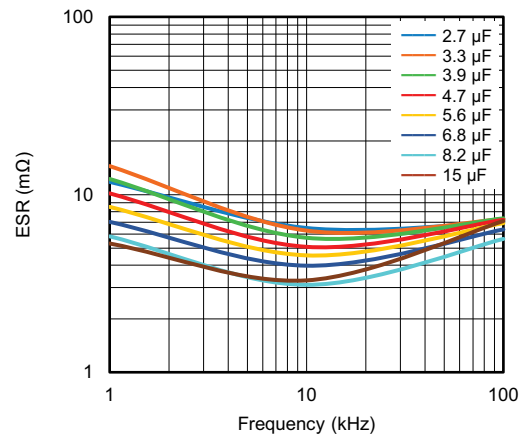

ESR as a function of frequency (630 V_{DC}) (typical curve)

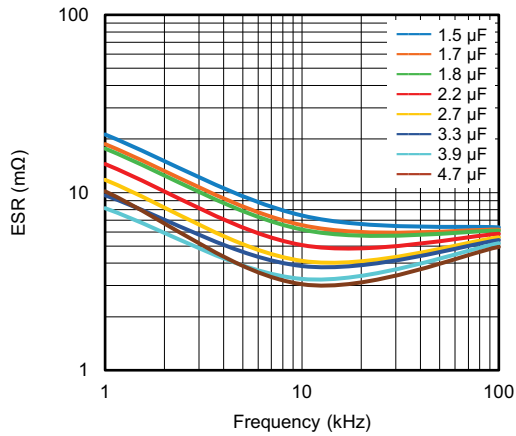

ESR as a function of frequency (850 V_{DC}) (typical curve)

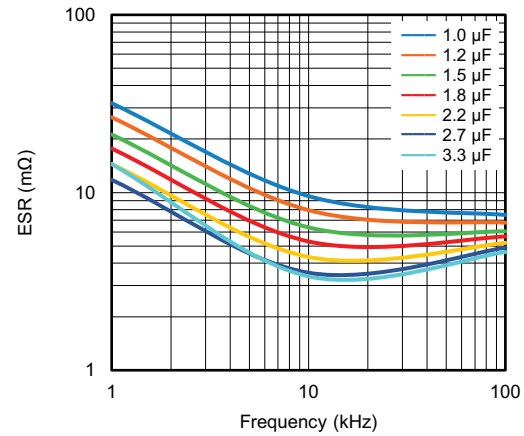

ESR as a function of frequency (1000 V_{DC}) (typical curve)

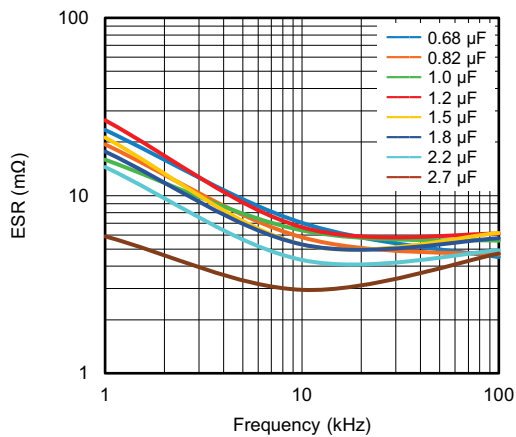

ESR as a function of frequency (1250 V_{DC}) (typical curve)

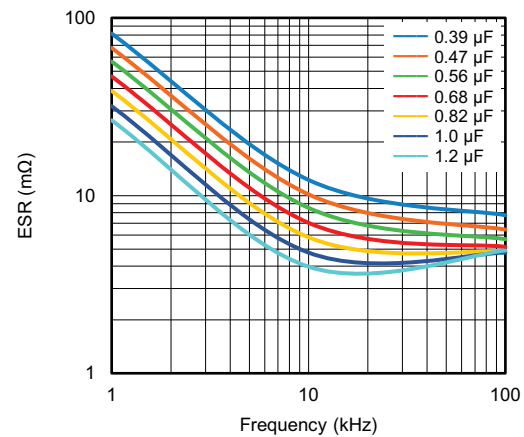

ESR as a function of frequency (1600 V_{DC}) (typical curve)

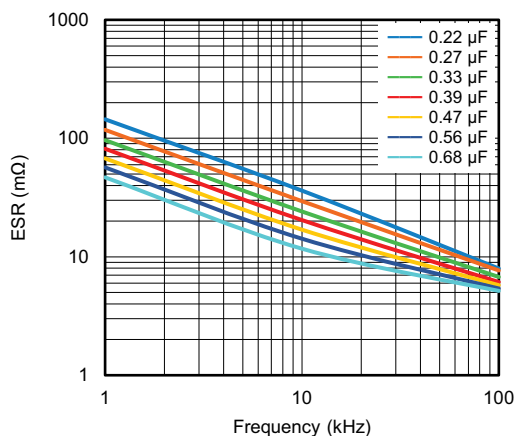

ESR as a function of frequency (2000 V_{DC}) (typical curve)

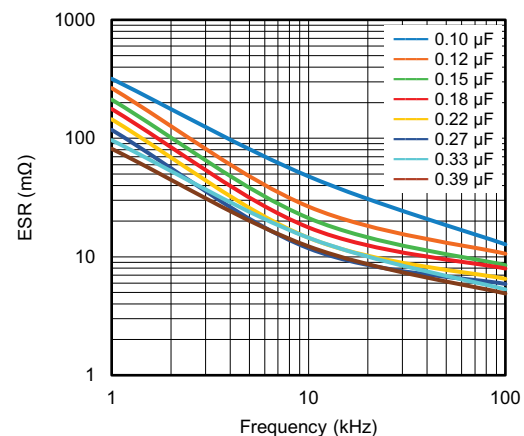

ESR as a function of frequency (2500 V_{DC}) (typical curve)

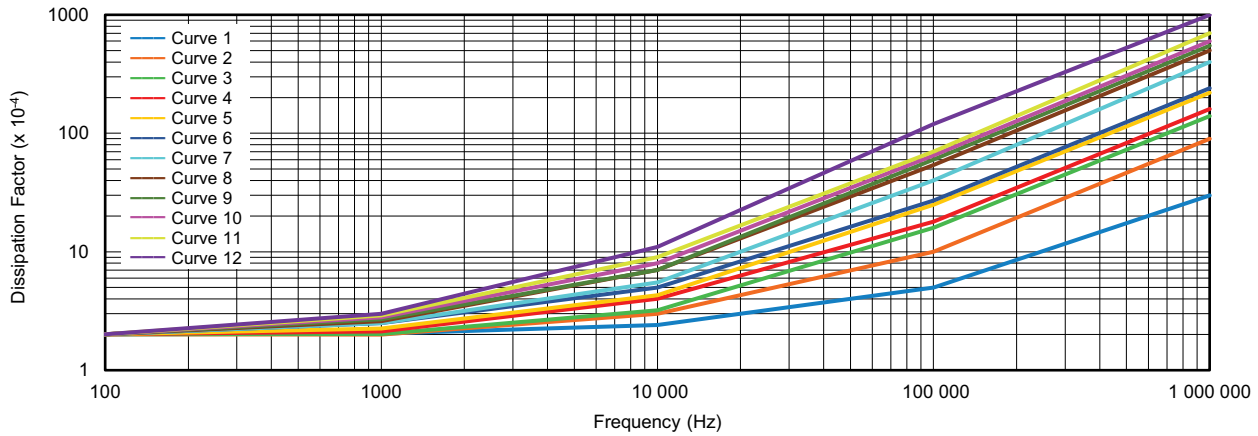
 Tangent of loss angle as a function of frequency
(typical curves)

400 V: 0.047 ≤ C ≤ 0.068 μF, curve 3 0.082 ≤ C ≤ 0.18 μF, curve 4 0.22 ≤ C ≤ 0.39 μF, curve 8 0.47 ≤ C ≤ 1.2 μF, curve 11 1.5 ≤ C ≤ 3.9 μF, curve 12	630 V: 0.027 ≤ C ≤ 0.033 μF, curve 2 0.039 ≤ C ≤ 0.1 μF, curve 3 0.12 ≤ C ≤ 0.24 μF, curve 7 0.27 ≤ C ≤ 1 μF, curve 9 1.2 ≤ C ≤ 2.2 μF, curve 10	850 V: 0.01 ≤ C ≤ 0.027 μF, curve 1 0.033 ≤ C ≤ 0.068 μF, curve 3 0.082 ≤ C ≤ 0.15 μF, curve 4 0.18 ≤ C ≤ 0.68 μF, curve 5 0.82 ≤ C ≤ 1.2 μF, curve 6	1000 V: 0.018 ≤ C ≤ 0.047 μF, curve 1 0.056 ≤ C ≤ 0.082 μF, curve 3 0.1 ≤ C ≤ 0.27 μF, curve 4 0.33 ≤ C ≤ 0.82 μF, curve 5
1250 V: 0.0082 ≤ C ≤ 0.039 μF, curve 1 0.047 ≤ C ≤ 0.082 μF, curve 3 0.1 ≤ C ≤ 0.56 μF, curve 4	1600 V: 0.0039 ≤ C ≤ 0.012 μF, curve 1 0.015 ≤ C ≤ 0.22 μF, curve 2 0.27 ≤ C ≤ 0.33 μF, curve 3	2000 V: 0.001 ≤ C ≤ 0.012 μF, curve 1 0.015 ≤ C ≤ 0.18 μF, curve 2	2500 V: 0.001 ≤ C ≤ 0.082 μF, curve 1

HEAT CONDUCTIVITY (G) AS A FUNCTION OF ORIGINAL PITCH AND CAPACITOR BODY THICKNESS IN mW/°C					
W_{max.} (mm)	HEAT CONDUCTIVITY (mW/°C)				
	PITCH 15 mm	PITCH 22.5 mm	PITCH 27.5 mm	PITCH 37.5 mm	PITCH 52.5 mm
7.0	14	22	-	-	-
8.5	16	25	-	-	-
9.0	19	-	29	-	-
10.0	21	29	-	-	-
10.5 / 11.0	22	-	34	-	-
12.0	-	34	-	-	-
12.5 / 13.0	-	36	40	-	-
15.0	-	-	45	-	-
15.7	-	-	-	55	-
18.0	-	-	54	64	-
18.5	-	-	-	71	-
21.0	-	-	63	-	-
21.5	-	-	-	82	-
24.0	-	-	-	94	-
25.0	-	-	-	-	-
30.0	-	-	-	108	-
35.0	-	-	-	-	146

POWER DISSIPATION AND MAXIMUM COMPONENT TEMPERATURE RISE

The power dissipation must be limited in order not to exceed the maximum allowed component temperature rise as a function of the free air ambient temperature.

The power dissipation can be calculated according type detail specification www.vishay.com/doc?28147

The component temperature rise (ΔT) can be measured (see section “Measuring the component temperature” for more details) or calculated by $\Delta T = P/G$:

- ΔT = component temperature rise (°C)
- P = power dissipation of the component (mW)
- G = heat conductivity of the component (mW/°C)

MEASURING THE COMPONENT TEMPERATURE

A thermocouple must be attached to the capacitor body as in:

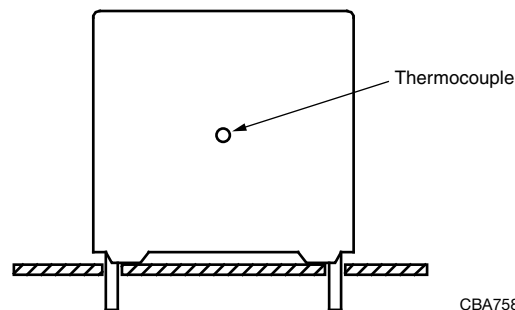

The temperature is measured in unloaded (T_{amb}) and maximum loaded condition (T_C).

The temperature rise is given by $\Delta T = T_C - T_{amb}$.

To avoid radiation or convection, the capacitor should be tested in a wind-free box.

APPLICATION NOTES

For capacitors connected in parallel, normally the proof voltage and possibly the rated voltage must be reduced. For information depending of the capacitance value and the number of parallel connections contact: dc-film@vishay.com

These capacitors are not suitable for mains applications as across-the-line capacitors without additional protection, as described hereunder. These mains applications are strictly regulated in safety standards and therefore electromagnetic interference suppression capacitors conforming the standards must be used.

To select the capacitor for a certain application, the following conditions must be checked:

1. The peak voltage (U_p) shall not be greater than the rated DC voltage (U_{RDC})
2. The peak-to-peak voltage (U_{p-p}) shall not be greater than the maximum (U_{p-p}) to avoid the ionization inception level
3. The voltage peak slope (dU/dt) shall not exceed the rated voltage pulse slope in an RC-circuit at rated voltage and without ringing. If the pulse voltage is lower than the rated DC voltage, the rated voltage pulse slope may be multiplied by U_{RDC} and divided by the applied voltage.

For all other pulses following equation must be fulfilled:

$$2 \times \int_0^T \left(\frac{dU}{dt} \right)^2 \times dt < U_{RDC} \times \left(\frac{dU}{dt} \right)_{\text{rated}}$$

T is the pulse duration

4. The maximum component surface temperature rise must be lower than the limits (see graph "Max. allowed component temperature rise")
5. Since in circuits used at voltages over 280 V peak-to-peak the risk for an intrinsically active flammability after a capacitor breakdown (short circuit) increases, it is recommended that the power to the component is limited to 100 times the values mentioned in the table: "Heat Conductivity"
6. When using these capacitors as across-the-line capacitor in the input filter for mains applications or as series connected with an impedance to the mains the applicant must guarantee that the following conditions are fulfilled in any case (spikes and surge voltages from the mains included)

Note

- See table "Voltage Ratings and Temperature"

7. For capacitors with multiple pins in some cases it is allowed to feed current through the pins additionally to the capacitor to improve filtering properties

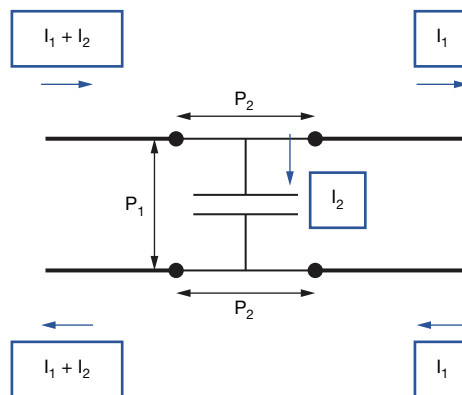

P_1 and P_2 are the pin distance dimensions as mentioned in the mechanical dimensions.

In this case the pins carry the currents I_1 (= the fed through current) and I_2 (= the capacitor current). Due to the additional heating up this fed through current must be limited to 10 % of the maximum allowed capacitor current I_2 . For other currents contact dc-film@vishay.com.



INSPECTION REQUIREMENTS

General Notes

Sub-clause numbers of tests and performance requirements refer to the “Sectional Specification, Specific Reference Data”.

IEC 60384-17 - FIXED METALLIZED POLYPROPYLENE FILM DIELECTRIC AC AND PULSE CAPACITORS		
SUB-CLAUSE NUMBER AND TEST	CONDITIONS	PERFORMANCE REQUIREMENTS
SUB-GROUP C1A PART OF SAMPLE OF SUB-GROUP C1		
4.1 Dimensions (detail)		As specified in Chapters “General data” of this specification
4.3.1 Initial measurements	Capacitance Tangent of loss angle: $C \leq 1 \mu\text{F}$ at 100 kHz $C > 1 \mu\text{F}$ at 10 kHz	
4.3 Robustness of terminations	Tensile: load 10 N; 10 s Bending: load 5 N; 4 x 90°	No visible damage
4.4 Resistance to soldering heat	Method: 1 A Solder bath: 280 °C ± 5 °C Duration: 10 s	
4.14 Component solvent resistance	Isopropylalcohol at room temperature Method: 2 Immersion time: 5 min ± 0.5 min Recovery time: min. 1 h, max. 2 h	
4.4.2 Final measurements	Visual examination Capacitance Tangent of loss angle	No visible damage Legible marking $I\Delta C/C_i \leq 1\%$ of the value measured initially. Increase of tan δ : ≤ 0.0005 for: $C \leq 100 \text{ nF}$ at 100 kHz ≤ 0.0010 for: $100 \text{ nF} < C \leq 470 \text{ nF}$ at 100 kHz ≤ 0.0015 for: $470 \text{ nF} < C \leq 1 \mu\text{F}$ at 100 kHz ≤ 0.0015 for: $C > 1 \mu\text{F}$ at 10 kHz Compared to values measured in 4.3.1
SUB-GROUP C1B OTHER PART OF SAMPLE OF SUB-GROUP C1		
4.6.1 Initial measurements	Capacitance Tangent of loss angle: $C \leq 1 \mu\text{F}$ at 100 kHz $C > 1 \mu\text{F}$ at 10 kHz	
4.15 Solvent resistance of the marking	Isopropylalcohol at room temperature Method: 1 Rubbing material: cotton wool Immersion time: 5 min ± 0.5 min	No visible damage Legible marking
4.6 Rapid change of temperature	$\theta A = -40 \text{ °C}$ $\theta B = +105 \text{ °C}$ 5 cycles Duration $t = 30 \text{ min}$ Visual examination	No visible damage



IEC 60384-17 - FIXED METALLIZED POLYPROPYLENE FILM DIELECTRIC AC AND PULSE CAPACITORS		
SUB-CLAUSE NUMBER AND TEST	CONDITIONS	PERFORMANCE REQUIREMENTS
SUB-GROUP C1B OTHER PART OF SAMPLE OF SUB-GROUP C1		
4.7. Vibration	Mounting: see section "Mounting" for more information Procedure B4 Frequency range: 10 Hz to 55 Hz. Amplitude: 0.75 mm or acceleration 98 m/s ² (whichever is less severe) Total duration 6 h.	
4.7.2 Final inspection	Visual examination Mounting: see section "Mounting" for more information	No visible damage
4.9 Shock	Pulse shape: half sine Acceleration: 490 m/s ² Duration of pulse: 11 ms	
4.9.3 Final measurements	Visual examination Capacitance Tangent of loss angle Insulation resistance	No visible damage $I\Delta C/CI \leq 2\%$ of the value measured in 4.6.1. Increase of $\tan \delta$: ≤ 0.0005 ≤ 0.0010 for: $C \leq 100$ nF at 100 kHz ≤ 0.0010 for: 100 nF < $C \leq 470$ nF at 100 kHz ≤ 0.0015 for: 470 nF < $C \leq 1$ μ F at 100 kHz ≤ 0.0015 for: $C > 1$ μ F at 10 kHz Compared to values measured in 4.6.1 As specified in section "Insulation Resistance" of this specification.
SUB-GROUP C1 COMBINED SAMPLE OF SPECIMENS OF SUB-GROUPS C1A AND C1B		
4.10 Climatic sequence		
4.10.2 Dry heat	Temperature +105 °C Duration: 16 h	
4.10.3 Damp heat cyclic Test Db, first cycle		
4.10.4 Cold	Temperature: -40 °C Duration: 2 h	
4.10.6 Damp heat cyclic Test Db remaining cycles		
4.10.6.2 Final measurements	Voltage proof = U_{RDC} for 1 min within 15 min after removal from test chamber Visual examination Capacitance Tangent of loss angle Insulation resistance	No breakdown or flashover No visible damage Legible marking $I\Delta C/CI \leq 2\%$ of the value measured in 4.4.2 or 4.9.3 Increase of $\tan \delta$: ≤ 0.0005 for: $C \leq 100$ nF at 100 kHz ≤ 0.0010 for: 100 nF < $C \leq 470$ nF at 100 kHz ≤ 0.0015 for: 470 nF < $C \leq 1$ μ F at 100 kHz ≤ 0.0015 for: $C > 1$ μ F at 10 kHz Compared to values measured in 4.3.1 or 4.6.1 $\geq 50\%$ of values specified in section "Insulation Resistance" of this specification.



IEC 60384-17 - FIXED METALLIZED POLYPROPYLENE FILM DIELECTRIC AC AND PULSE CAPACITORS		
SUB-CLAUSE NUMBER AND TEST	CONDITIONS	PERFORMANCE REQUIREMENTS
SUB-GROUP C2		
4.11 Damp heat steady state	56 days; 40 °C; 90 % to 95 % RH no load	
4.11.1 Initial measurements	Capacitance Tangent of loss angle at 1 kHz	
4.11.3 Final measurements	Voltage proof = U_{RDC} for 1 min within 15 min after removal from test chamber	No breakdown or flashover
	Visual examination	No visible damage Legible marking
	Capacitance	$ \Delta C/C \leq 2\%$ of the value measured in 4.11.1.
	Tangent of loss angle	Increase of $\tan \delta \leq 0.0025$ at 1 kHz Compared to values measured in 4.11.1.
	Insulation resistance	$\geq 50\%$ of values specified in section “Insulation resistance” of this specification
SUB-GROUP C2A		
4.12A Damp heat steady state with load	60 °C; 93 % RH load: U_{RDC} duration: 56 days	
4.12.1A Initial measurements	Capacitance Tangent of loss angle at for $C \leq 1 \mu F$ at 10 kHz for $C > 1 \mu F$ at 1 kHz	
4.12.3A Final measurements	Visual examination	No visible damage Legible marking
	Capacitance	$ \Delta C/C \leq 10\%$ of the value measured in 4.12.1.
	Tangent of loss angle	Increase of $\tan \delta$: ≤ 0.0240 for $C \leq 1 \mu F$ or ≤ 0.0150 for $C > 1 \mu F$ Compared to values measured in 4.12.1.
	Voltage proof U_{RDC} ; 1 min between terminations	No permanent breakdown or flashover
	Insulation resistance	$\geq 50\%$ of values specified in section “Insulation resistance” of this specification



IEC 60384-17 - FIXED METALLIZED POLYPROPYLENE FILM DIELECTRIC AC AND PULSE CAPACITORS		
SUB-CLAUSE NUMBER AND TEST	CONDITIONS	PERFORMANCE REQUIREMENTS
SUB-GROUP C3A		
4.12.1 Endurance	Duration: 2000 h Temperature: 85 °C Voltage: 1.25 x U _{RAC} V _{RMS} , 50 Hz AND Duration: 2000 h Temperature: 105 °C Voltage: 0.875 x U _{RAC} V _{RMS} , 50 Hz	
4.12.1.1 Initial measurements	Capacitance Tangent of loss angle C ≤ 1 μF at 100 kHz C > 1 μF at 10 kHz	
4.12.1.3 Final measurements	Visual examination Capacitance Tangent of loss angle Insulation resistance	No visible damage Legible marking ΔC/Ci ≤ 5 % for C > 10 nF ΔC/Ci ≤ 8 % for C ≤ 10 nF Compared to values measured in 4.12.1.1 Increase of tan δ: ≤ 0.0005 for: C ≤ 100 nF at 100 kHz ≤ 0.0010 for: 100 nF < C ≤ 470 nF at 100 kHz ≤ 0.0015 for: 470 nF < C ≤ 1 μF at 100 kHz ≤ 0.0015 for: C > 1 μF at 10 kHz Compared to values measured in 4.12.1.1 ≥ 50 % of values specified in section “Insulation resistance” of this specification.
SUB-GROUP C3B		
4.12.2 Endurance test at 50 Hz alternating voltage	0.625 x U _{RAC} at 125 °C 500 h	
4.12.2.1 Initial measurements	Capacitance Tangent of loss angle: C ≤ 1 μF at 100 kHz C > 1 μF at 10 kHz	
4.12.2.3 Final measurements	Visual examination Capacitance Tangent of loss angle Insulation resistance	No visible damage Legible marking ΔC/Ci ≤ 10 % + 100 pF compared to values measured in 4.12.2.1 Increase of tan δ: ≤ 0.0005 for: C ≤ 100 nF at 100 kHz ≤ 0.0010 for: 100 nF < C ≤ 470 nF at 100 kHz ≤ 0.0015 for: 470 nF < C ≤ 1 μF at 100 kHz ≤ 0.0015 for: C > 1 μF at 10 kHz Compared to values measured in 4.12.2.1 ≥ 50 % of values specified in section “Insulation Resistance” of this specification.



IEC 60384-17 - FIXED METALLIZED POLYPROPYLENE FILM DIELECTRIC AC AND PULSE CAPACITORS		
SUB-CLAUSE NUMBER AND TEST	CONDITIONS	PERFORMANCE REQUIREMENTS
SUB-GROUP C4		
4.2.6 Temperature characteristics Initial measurements Intermediate measurements	Capacitance Capacitance at -40 °C Capacitance at 20 °C Capacitance at +125 °C	For -40 °C to +20 °C: +1 % ≤ ΔC/CI ≤ 3.75 % or for 20 °C to 125 °C: -7.5 % ≤ ΔC/CI ≤ 0 % Compared to values measured in 4.12.1.1
Final measurements	Capacitance	As specified in section “Capacitance” of this specification
	Insulation resistance	As specified in section “Insulation Resistance” of this specification
4.13 Charge and discharge	10 000 cycles Charged to U _{RDC} Discharge resistance: $R = \frac{U_{RDC}}{2.5 \times C (dU/dt)}$	
4.13.1 Initial measurements	Capacitance Tangent of loss angle: C ≤ 1 μF at 100 kHz 1 μF < C ≤ 10 μF at 10 kHz C > 10 μF at 1 kHz	
4.13.3 Final measurements	Capacitance	ΔC/CI ≤ 1 % compared to values measured in 4.13.1.
	Tangent of loss angle	Increase of tan δ: ≤ 0.0005 for: C ≤ 100 nF at 100 kHz ≤ 0.0010 for: 100 nF < C ≤ 470 nF at 100 kHz ≤ 0.0015 for: 470 nF < C ≤ 1 μF at 100 kHz ≤ 0.0015 for: C > 1 μF at 10 kHz Compared to values measured in 4.13.1
	Insulation resistance	≥ 50 % of values specified in section “Insulation Resistance” of this specification.



AUTOMOTIVE AEC-Q200, REVISION D QUALIFICATION				
STRESS	REVISION	CONDITION	SAMPLE SIZE	PERFORMANCE REQUIREMENTS
1. High temperature exposure (storage)	D	Test as per MIL-STD 202, method 108 Temp.: 105 °C; unpowered Duration: 1000 h	77	$ \Delta C/C \leq 5\%$ ≤ 0.0005 for: $C \leq 100$ nF at 100 kHz ≤ 0.0010 for: 100 nF $< C \leq 470$ nF at 100 kHz ≤ 0.0015 for: 470 nF $< C \leq 1$ μ F at 100 kHz ≤ 0.0015 for: $C > 1$ μ F at 10 kHz IR $> 50\%$ of initial specified value
2. Temperature cycling	D	Test as per JESD22, method JA-104 Total no. of cycles: 1000 cycles Lower temp.: -40 °C Upper temp.: +105 °C Dwell each 30 min as per rev. D	77	$ \Delta C/C \leq 5\%$ Increase of tan δ : ≤ 0.0005 for: $C \leq 100$ nF at 100 kHz ≤ 0.0010 for: 100 nF $< C \leq 470$ nF at 100 kHz ≤ 0.0015 for: 470 nF $< C \leq 1$ μ F at 100 kHz ≤ 0.0015 for: $C > 1$ μ F at 10 kHz IR $> 50\%$ of initial specified value
3. Moisture resistance	D	Test as per MIL-STD 202, method 106 10 cycles at 24 h/cycle unpowered	77	$ \Delta C/C \leq 5\%$ Increase of tan δ : ≤ 0.0005 for: $C \leq 100$ nF at 100 kHz ≤ 0.0010 for: 100 nF $< C \leq 470$ nF at 100 kHz ≤ 0.0015 for: 470 nF $< C \leq 1$ μ F at 100 kHz ≤ 0.0015 for: $C > 1$ μ F at 10 kHz IR $> 50\%$ of initial specified value
4. Biased humidity AC	D	Test as per MIL-STD 202, method 103 Temp.: 40 °C; RH: 93 %; U_{RAC} Duration: 1000 h	77	$ \Delta C/C \leq 5\%$ Increase of tan δ : ≤ 0.008 at 1 kHz IR $> 50\%$ of initial specified value
5. Biased humidity DC	D	Test as per MIL-STD 202, method 103 Temp.: 40 °C; RH: 93 %; U_{RDC} Duration: 1000 h	77	$ \Delta C/C \leq 5\%$ Increase of tan δ : ≤ 0.008 at 1 kHz IR $> 50\%$ of initial specified value
6. Operational life AC	D	Test as per MIL-STD 202, method 108 Temp. = 105 °C; load = U_{RAC} Duration: 1000 h	77	$ \Delta C/C \leq 5\%$ Increase of tan δ : ≤ 0.0005 for: $C \leq 100$ nF at 100 kHz ≤ 0.0010 for: 100 nF $< C \leq 470$ nF at 100 kHz ≤ 0.0015 for: 470 nF $< C \leq 1$ μ F at 100 kHz ≤ 0.0015 for: $C > 1$ μ F at 10 kHz IR $> 50\%$ of initial specified value
7. Operational life DC	D	Test as per MIL-STD 202, method 108 Temp. = 105 °C; Load = U_{RDC} Duration: 1000 h	77	$ \Delta C/C \leq 5\%$ Increase of tan δ : ≤ 0.0005 for: $C \leq 100$ nF at 100 kHz ≤ 0.0010 for: 100 nF $< C \leq 470$ nF at 100 kHz ≤ 0.0015 for: 470 nF $< C \leq 1$ μ F at 100 kHz ≤ 0.0015 for: $C > 1$ μ F at 10 kHz IR $> 50\%$ of initial specified value
8. Terminal strength (lead)	D	Test as per MIL-STD 202, method 211 Test leaded device lead integrity only. - A (pull-test): 2.27 kg (10 s) - C (wire-lead bend test): 227 g (3 x 3 s)	30	No visual damage
9. Resistance to solvents	D	MIL-STD-202 method 215 - Also aqueous chemical - OKEM clean or equivalent. Do not use banned solvents.	5	No visual damage Legible marking
10. Mechanical shock	D	MIL-STD-202 method 213 100 g's; 6 ms; half sine; 3.75 m/s	30	No visual damage



AUTOMOTIVE AEC-Q200, REVISION D QUALIFICATION				
STRESS	REVISION	CONDITION	SAMPLE SIZE	PERFORMANCE REQUIREMENTS
11. Vibration	D	MIL-STD-202 method 204 5 g's for 20 min 12 cycles x 3 directions 10 Hz to 2000 Hz	30	No visual damage
12. Resistance to soldering heat	D	MIL-STD-202 method 210 Temp.: 280 °C; time: 10 s solder within 1.5 mm of device body	30	$ \Delta C/C \leq 5\%$ Increase of tan δ : ≤ 0.0005 for: $C \leq 100$ nF at 100 kHz ≤ 0.0010 for: 100 nF < $C \leq 470$ nF at 100 kHz ≤ 0.0015 for: 470 nF < $C \leq 1$ μ F at 100 kHz ≤ 0.0015 for: $C > 1$ μ F at 10 kHz IR > 50 % of initial specified value
13. Solderability	D	J-STD-002 Leaded: method A at 235 °C, category 3 (245 °C / 3 s)	15	Good tinning as evidence by free flowing of the solder with wetting of terminations > 95 %
14. Flammability	D	UL-94 One flame application Class B	15	V-0 is acceptable. Class B or C according IEC is also acceptable



Disclaimer

ALL PRODUCT, PRODUCT SPECIFICATIONS AND DATA ARE SUBJECT TO CHANGE WITHOUT NOTICE TO IMPROVE RELIABILITY, FUNCTION OR DESIGN OR OTHERWISE.

Vishay Intertechnology, Inc., its affiliates, agents, and employees, and all persons acting on its or their behalf (collectively, "Vishay"), disclaim any and all liability for any errors, inaccuracies or incompleteness contained in any datasheet or in any other disclosure relating to any product.

Vishay makes no warranty, representation or guarantee regarding the suitability of the products for any particular purpose or the continuing production of any product. To the maximum extent permitted by applicable law, Vishay disclaims (i) any and all liability arising out of the application or use of any product, (ii) any and all liability, including without limitation special, consequential or incidental damages, and (iii) any and all implied warranties, including warranties of fitness for particular purpose, non-infringement and merchantability.

Statements regarding the suitability of products for certain types of applications are based on Vishay's knowledge of typical requirements that are often placed on Vishay products in generic applications. Such statements are not binding statements about the suitability of products for a particular application. It is the customer's responsibility to validate that a particular product with the properties described in the product specification is suitable for use in a particular application. Parameters provided in datasheets and / or specifications may vary in different applications and performance may vary over time. All operating parameters, including typical parameters, must be validated for each customer application by the customer's technical experts. Product specifications do not expand or otherwise modify Vishay's terms and conditions of purchase, including but not limited to the warranty expressed therein.

Hyperlinks included in this datasheet may direct users to third-party websites. These links are provided as a convenience and for informational purposes only. Inclusion of these hyperlinks does not constitute an endorsement or an approval by Vishay of any of the products, services or opinions of the corporation, organization or individual associated with the third-party website. Vishay disclaims any and all liability and bears no responsibility for the accuracy, legality or content of the third-party website or for that of subsequent links.

Except as expressly indicated in writing, Vishay products are not designed for use in medical, life-saving, or life-sustaining applications or for any other application in which the failure of the Vishay product could result in personal injury or death. Customers using or selling Vishay products not expressly indicated for use in such applications do so at their own risk. Please contact authorized Vishay personnel to obtain written terms and conditions regarding products designed for such applications.

No license, express or implied, by estoppel or otherwise, to any intellectual property rights is granted by this document or by any conduct of Vishay. Product names and markings noted herein may be trademarks of their respective owners.