

### FEATURES

- RoHS compliant
- Efficiency up to 82%
- Wide temperature performance at full 1 Watt load, -40°C to 85°C
- UL 94V-0 package material
- Footprint over pins 1.64cm<sup>2</sup>
- Lead frame technology
- Dual isolated output
- 5V & 12V inputs
- 5V, 9V, 12V & 15V outputs
- Internal SMD construction
- Toroidal magnetics
- Plastic encapsulated
- 3kVDC isolation (1 minute)
- MTTF up to 1.7 million hours
- Power density 1.36W/cm<sup>3</sup>
- No heatsink required
- Custom solutions available
- Multi layer ceramic capacitors

### PRODUCT OVERVIEW

The NTV series of 3kV isolation miniature surface mounted DC-DC converters employ leadframe technology and transfer moulding techniques to bring all of the benefits of IC style packaging to hybrid circuitry. The co-planarity of the pin positions is based upon IEC 191-6:1990. The devices are suitable for all applications where high volume production is envisaged.



For full details go to <https://www.murata.com/en-global/products/power/rohs>

### SELECTION GUIDE

Order Code <sup>1</sup>	Nominal Input Voltage	Output Voltage	Output Current	Input Current at Rated Load	Efficiency	Isolation Capacitance	MTTF <sup>2</sup>	Recommended Alternative
	V	V	mA	mA	%	pF	kHrs	
<span style="border: 1px solid green; border-radius: 5px; padding: 2px;">Recommended</span> <span style="border: 1px solid blue; border-radius: 5px; padding: 2px; margin-left: 10px;">In Production</span>								
NTV0505MC	5	±5	±100	282	71	33	1697	
NTV0509MC	5	±9	±55	260	77	38	682	
NTV0515MC	5	±15	±33	250	80	43	188	
NTV1212MC	12	±12	±42	104	80	89	243	
NTV1215MC	12	±15	±33	101	82	100	154	
<span style="background-color: red; color: white; border-radius: 5px; padding: 2px;">To be discontinued</span>								
NTV0512MC	5	±12	±42	253	79	44	343	NKA0512SC
NTV1205MC	12	±5	±100	114	73	50	559	NKA1205SC
<span style="background-color: black; color: white; border-radius: 5px; padding: 2px;">Discontinued</span>								
NTV1209MC	12	±9	±55	105	79	72	375	MEJ1D1209SC

When operated **with** additional external load capacitance the rise time of the input voltage will determine the maximum external capacitance value for guaranteed start up. The slower the rise time of the input voltage the greater the maximum value of the additional external capacitance for reliable start up.

### INPUT CHARACTERISTICS

Parameter	Conditions	Min.	Typ.	Max.	Units
Voltage range	Continuous operation, 5V input types	4.5	5	5.5	V
	Continuous operation, 12V input types	10.8	12	13.2	
Reflected ripple current			41	47	mA p-p

### ISOLATION CHARACTERISTICS

Parameter	Conditions	Min.	Typ.	Max.	Units
Isolation test voltage	Flash tested for 1 minute	3000			VDC
Resistance	Viso= 1000VDC	10			GΩ

### OUTPUT CHARACTERISTICS

Parameter	Conditions	Min.	Typ.	Max.	Units
Rated Power	T <sub>A</sub> =-40°C to 85°C			1.0	W
Voltage Set Point Accuracy	See tolerance envelope				
Line regulation	High V <sub>IN</sub> to low V <sub>IN</sub>		1.0	1.2	%/%
Load Regulation <sup>3</sup>	10% load to rated load, 5V output types		10	12	%
	10% load to rated load, 9V output types		6.5	8.0	
	10% load to rated load, 12V output types		6.0	8.5	
	10% load to rated load, 15V output types		6.0	7.0	
Ripple and Noise	BW=DC to 20MHz, 5V output types		50	75	mV p-p
	BW=DC to 20MHz, 9V output types		40	65	
	BW=DC to 20MHz, 12V output types		40	60	
	BW=DC to 20MHz, 15V output types		40	60	

### GENERAL CHARACTERISTICS

Parameter	Conditions	Min.	Typ.	Max.	Units
Switching frequency	5V input types		115		kHz
	12V input types		120		

1. If components are required in tape and reel format suffix order code code with -R, e.g. NTV0505MC-R.
  2. Calculated using MIL-HDBK-217F with nominal input voltage at full load.
  3. 12V input types have typically 3% less load regulation change.
- All specifications typical at T<sub>A</sub>=25°C, nominal input voltage and rated output current unless otherwise specified.

### TEMPERATURE CHARACTERISTICS

Parameter	Conditions	Min.	Typ.	Max.	Units
Specification	All output types	-40		85	°C
Storage		-55		125	
Case temperature above ambient	5V output types		33		
	All other output types		25		
Cooling	Free air convection				

### ABSOLUTE MAXIMUM RATINGS

Internal power dissipation	550mW
Input voltage $V_{IN}$ , NTV05 types	7V
Input voltage $V_{IN}$ , NTV12 types	15V

### TEMPERATURE DERATING GRAPH

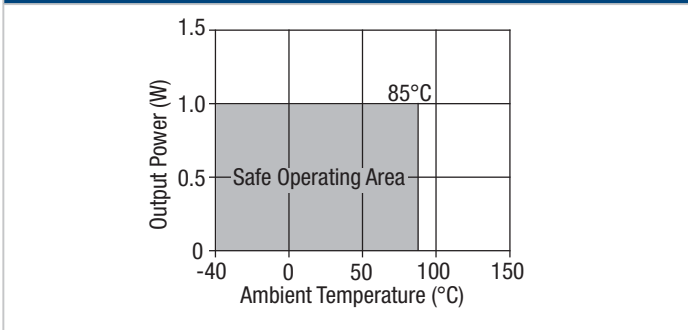

### TOLERANCE ENVELOPE

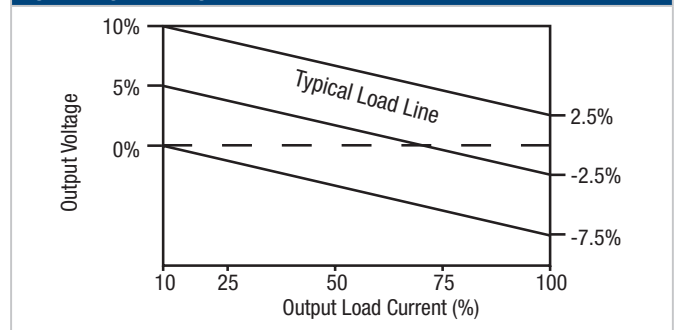

**TECHNICAL NOTES**

**ISOLATION VOLTAGE**

'Hi Pot Test', 'Flash Tested', 'Withstand Voltage', 'Proof Voltage', 'Dielectric Withstand Voltage' & 'Isolation Test Voltage' are all terms that relate to the same thing, a test voltage, applied for a specified time, across a component designed to provide electrical isolation, to verify the integrity of that isolation.

Murata Power Solutions NTV series of DC-DC converters are all 100% production tested at their stated isolation voltage. This is 3kVDC for 1 minute.

A question commonly asked is, "What is the continuous voltage that can be applied across the part in normal operation?"

For a part holding no specific agency approvals, such as the NTV series, both input and output should normally be maintained within SELV limits i.e. less than 42.4V peak, or 60VDC. The isolation test voltage represents a measure of immunity to transient voltages and the part should never be used as an element of a safety isolation system. The part could be expected to function correctly with several hundred volts offset applied continuously across the isolation barrier; but then the circuitry on both sides of the barrier must be regarded as operating at an unsafe voltage and further isolation/insulation systems must form a barrier between these circuits and any user-accessible circuitry according to safety standard requirements.

**REPEATED HIGH-VOLTAGE ISOLATION TESTING**

It is well known that repeated high-voltage isolation testing of a barrier component can actually degrade isolation capability, to a lesser or greater degree depending on materials, construction and environment. The NTV series has toroidal isolation transformers, with no additional insulation between primary and secondary windings of enamelled wire. While parts can be expected to withstand several times the stated test voltage, the isolation capability does depend on the wire insulation. Any material, including this enamel (typically polyurethane) is susceptible to eventual chemical degradation when subject to very high applied voltages thus implying that the number of tests should be strictly limited. We therefore strongly advise against repeated high voltage isolation testing, but if it is absolutely required, that the voltage be reduced by 20% from specified test voltage.

This consideration equally applies to agency recognised parts rated for better than functional isolation where the wire enamel insulation is always supplemented by a further insulation system of physical spacing or barriers.

**RoHS COMPLIANCE, MSL AND PSL INFORMATION**



This series is compatible with RoHS soldering systems and is also backward compatible with Sn/Pb soldering systems. The NTV series has a process, moisture, and reflow sensitivity classification of MSL1 PSL R7F as defined in J-STD-020 and J-STD-075. This translates to: MSL1 = unlimited floor life, PSL R7F = Peak reflow temperature 245°C with a limitation on the time above liquidus (217°C) which for this series is 60sec max. Please refer to [application notes](#) for further information. The pin termination finish on this product series is Gold with a plating thickness of 0.05 microns minimum.

For further information please visit [www.murata-ps.com/rohs](http://www.murata-ps.com/rohs)

**PART NUMBER STRUCTURE**

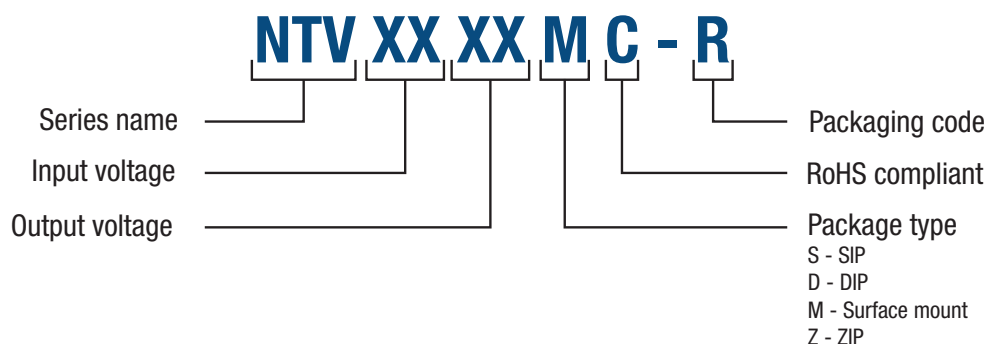

**APPLICATION NOTES**

**Minimum load**

The minimum load to meet datasheet specification is 10% of the full rated load across the specified input voltage range. Lower than 10% minimum loading will result in an increase in output voltage, which may rise to typically double the specified output voltage if the output load falls to less than 5%.

**PACKAGE SPECIFICATIONS**

**MECHANICAL DIMENSIONS**

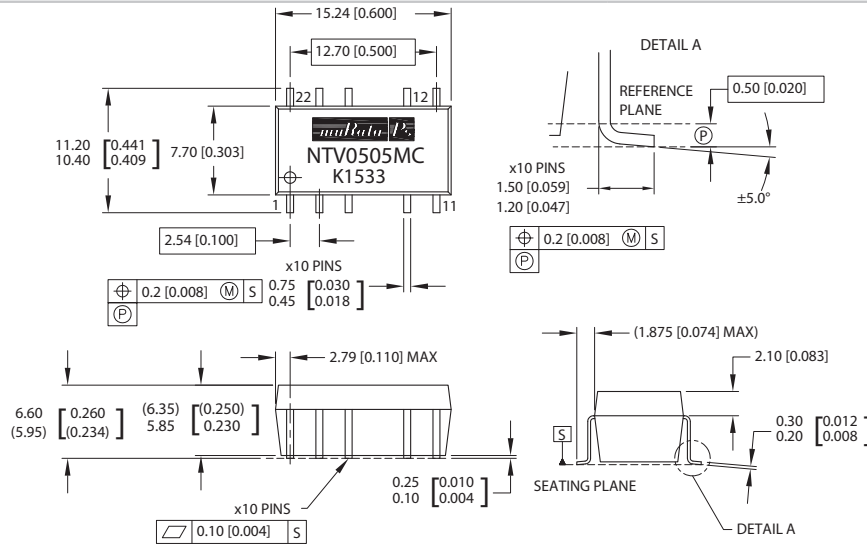

**PIN CONNECTIONS**

Pin	Function
1	-V <sub>IN</sub>
3	+V <sub>IN</sub>
5	NA
9	OV
11	-V <sub>OUT</sub>
12	NA
14	+V <sub>OUT</sub>
18	NA
20	NA
22	NA

NA - Not available for electrical connection.

**RECOMMENDED FOOTPRINT DETAILS**

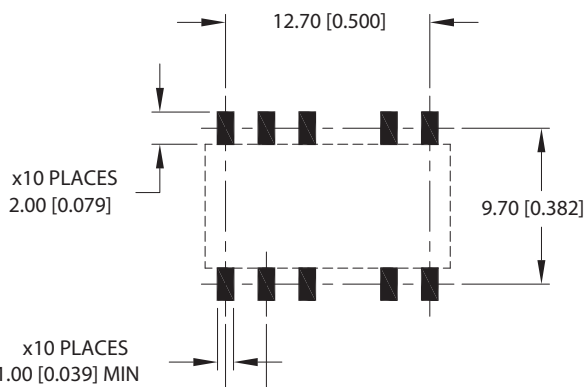

**TUBE OUTLINE DIMENSIONS**

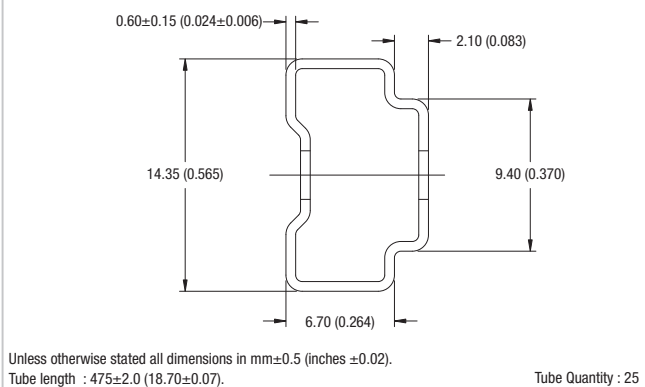

**TAPE & REEL SPECIFICATIONS**

**REEL OUTLINE DIMENSIONS**

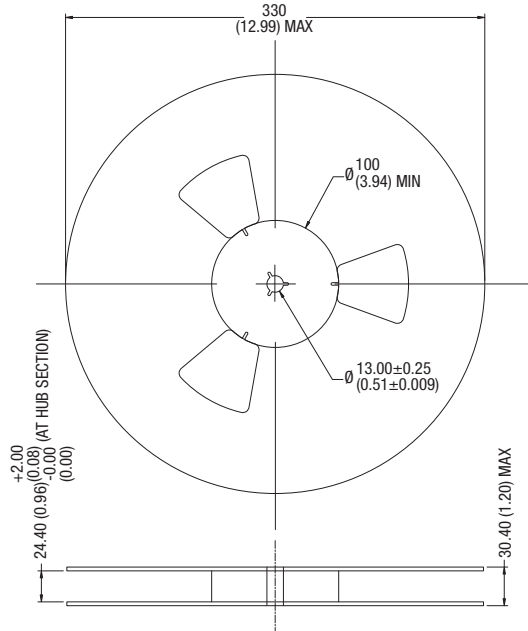

**TAPE OUTLINE DIMENSIONS**

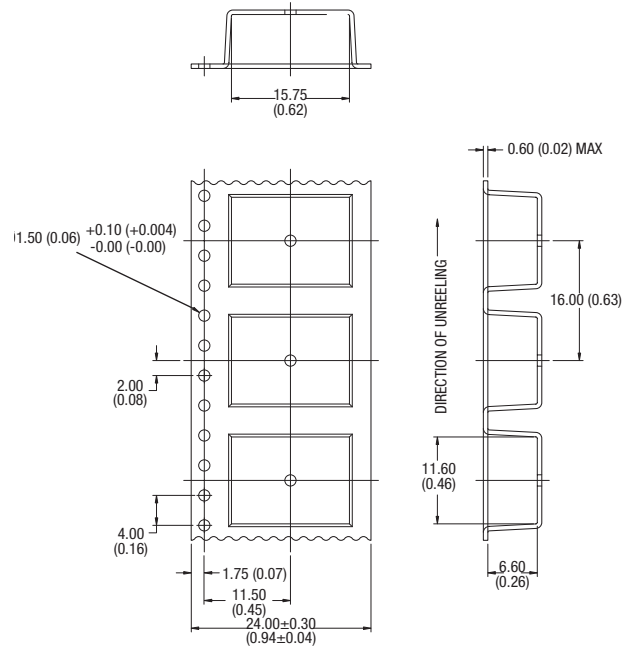

**REEL PACKAGING DETAILS**

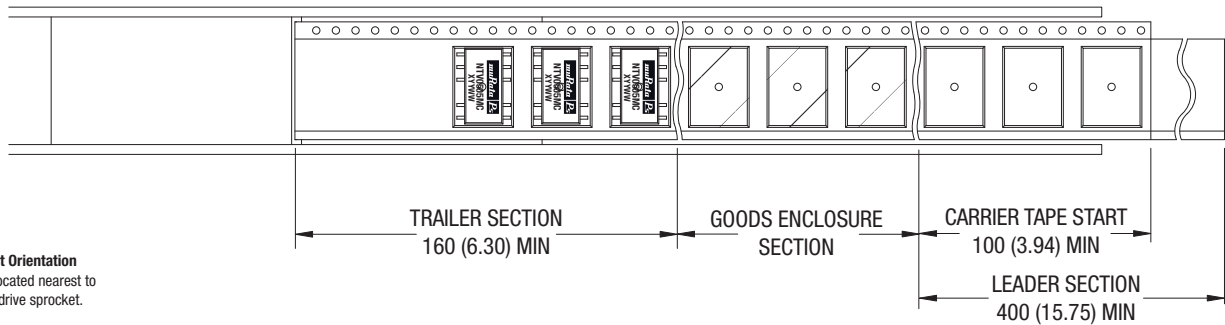

**Product Orientation**  
Pin 1, located nearest to carrier drive sprocket.

Reel Quantity : 500

**DISCLAIMER**

Unless otherwise stated in the datasheet, all products are designed for standard commercial and industrial applications and NOT for safety-critical and/or life-critical applications.

Particularly for safety-critical and/or life-critical applications, i.e. applications that may directly endanger or cause the loss of life, inflict bodily harm and/or loss or severe damage to equipment/property, and severely harm the environment, a prior explicit written approval from Murata is strictly required. Any use of Murata standard products for any safety-critical, life-critical or any related applications without any prior explicit written approval from Murata shall be deemed unauthorised use.

These applications include but are not limited to:

- Aircraft equipment
- Aerospace equipment
- Undersea equipment
- Power plant control equipment
- Medical equipment
- Transportation equipment ( automobiles, trains, ships, etc.)
- Traffic signal equipment
- Disaster prevention / crime prevention equipment
- Data Processing equipment

Murata makes no express or implied warranty, representation, or guarantee of suitability, fitness for any particular use/purpose and/or compatibility with any application or device of the buyer, nor does Murata assume any liability whatsoever arising out of unauthorised use of any Murata product for the application of the buyer. The suitability, fitness for any particular use/purpose and/or compatibility of Murata product with any application or device of the buyer remain to be the responsibility and liability of the buyer.

Buyer represents and agrees that it has all the necessary expertise to create and implement safeguards that anticipate dangerous consequences of failures, monitor failures and their consequences, lessen the likelihood of failures that might cause harm, and take appropriate remedial actions. Buyer will fully indemnify and hold Murata, its affiliated companies, and its representatives harmless against any damages arising out of unauthorised use of any Murata products in any safety-critical and/or life-critical applications.

Remark: Murata in this section refers to Murata Manufacturing Company and its affiliated companies worldwide including, but not limited to, Murata Power Solutions.



This product is subject to the following [operating requirements](https://www.murata.com/en-eu/products/power/requirements) and the [Life and Safety Critical Application Sales Policy](https://www.murata.com/en-eu/products/power/requirements):

Refer to: <https://www.murata.com/en-eu/products/power/requirements>

Murata Power Solutions (Milton Keynes) Ltd. makes no representation that the use of its products in the circuits described herein, or the use of other technical information contained herein, will not infringe upon existing or future patent rights. The descriptions contained herein do not imply the granting of licenses to make, use, or sell equipment constructed in accordance therewith. Specifications are subject to change without notice.  
© 2022 Murata Power Solutions (Milton Keynes) Ltd.