

Peak Sensitivity Wavelength: 855nm

The 855nm Point Source Series is designed for applications requiring high output and precise optical / mechanical axis alignment. Custom package solutions and sorting are available.

FEATURES

- > TO-18 Metal Can Package
- > Emitting Window Diameter $\Phi 150\mu\text{m}$
- > High Reliability
- > Wide Beam Angle

APPLICATIONS

- > Optical Switches / Security Systems
- > Linear & Rotary Encoder
- > Remote Controls / Robotics
- > Fiber Applications

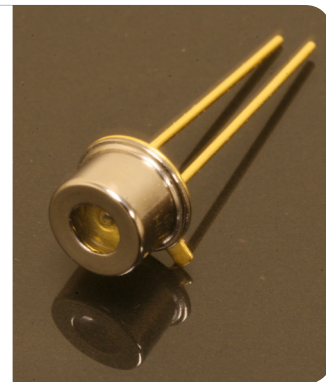

Absolute Maximum Ratings (Ta=25°C)



ITEMS	SYMBOL	RATINGS	UNIT
Forward Current	IF	100	mA
Forward Current (Pulse)*1	IFP	0.8	A
Reverse Voltage	VR	5	V
Power Dissipation	PD	190	mW
Operating Temperature Range	Topr	-20 ~ +85	°C
Storage Temperature Range	Tstg	-30 ~ +100	°C
Junction Temperature	Tj	100	°C
Lead Soldering Temperature*2	Tls	260	°C

*1: Tw=10μsec, T=10msec. *2: Time 5 Sec max, Position: Up to 3mm from the body.

Electrical & Optical Characteristics (Ta = 25°C)

ITEMS	SYMBOL	CONDITIONS	MIN	TYP	MAX	UNIT
Power Output	PO	IF=50mA	--	2.70	--	mW
Forward Voltage	VF	IF=50mA	--	1.59	--	V
Reverse Current	IR	VR=5V	--	--	100	μA
Peak Emission Wavelength	λ_p	IF=50mA	--	855	--	nm
Spectral Line Half Width	$\Delta\lambda$	IF=50mA	--	31	--	nm
Half Intensity Beam Angle	Θ	IF=50mA	--	+/-50	--	deg

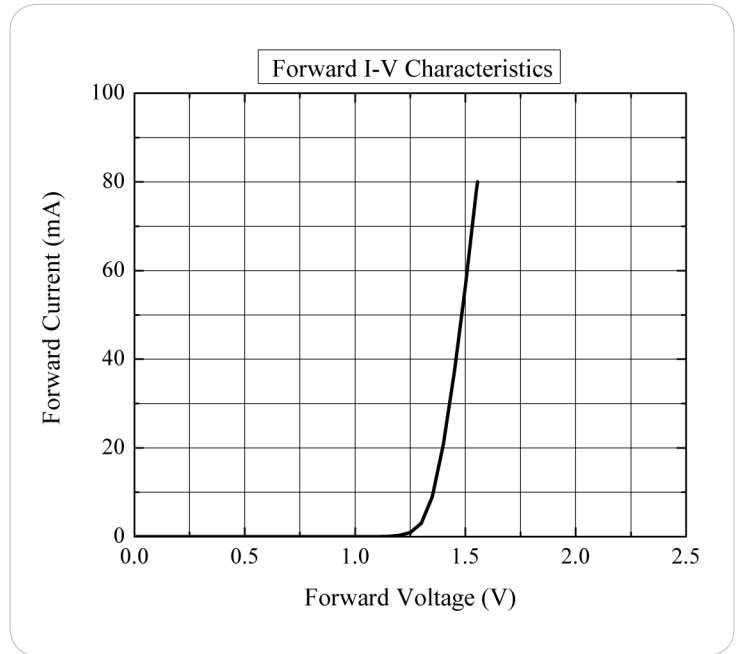
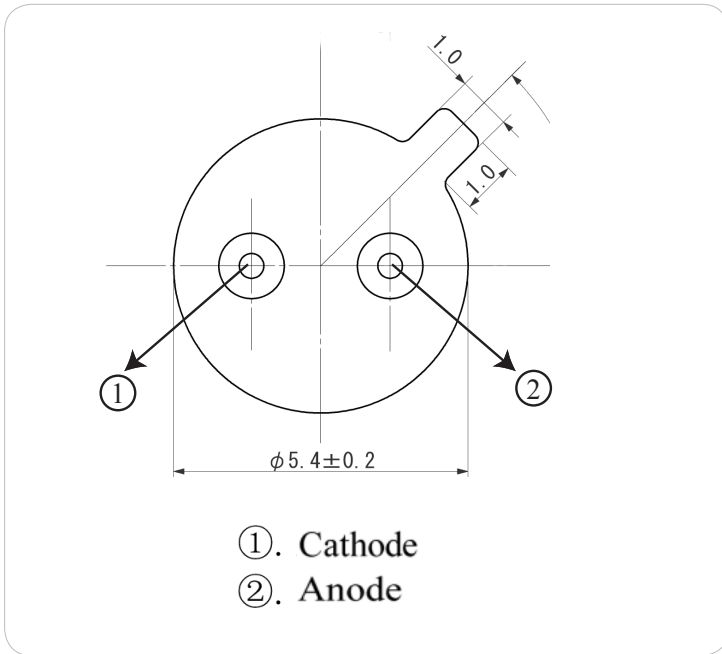
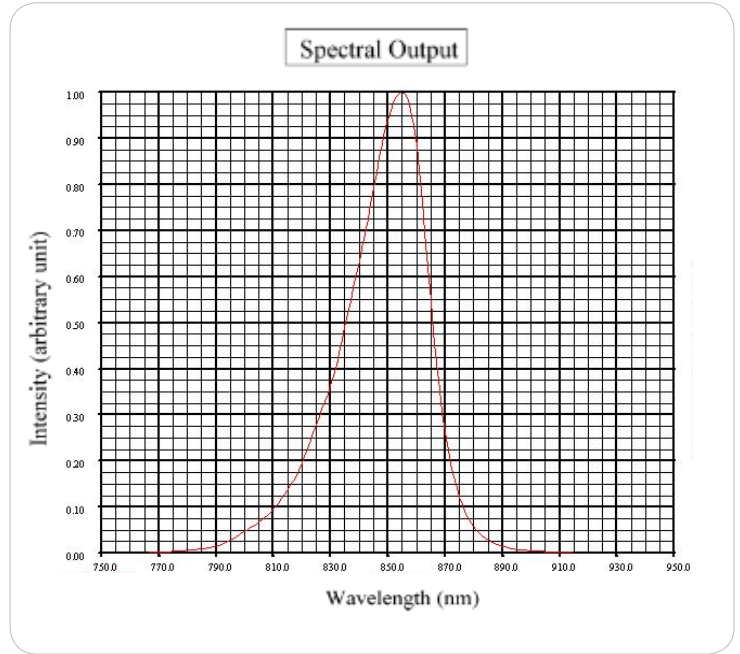
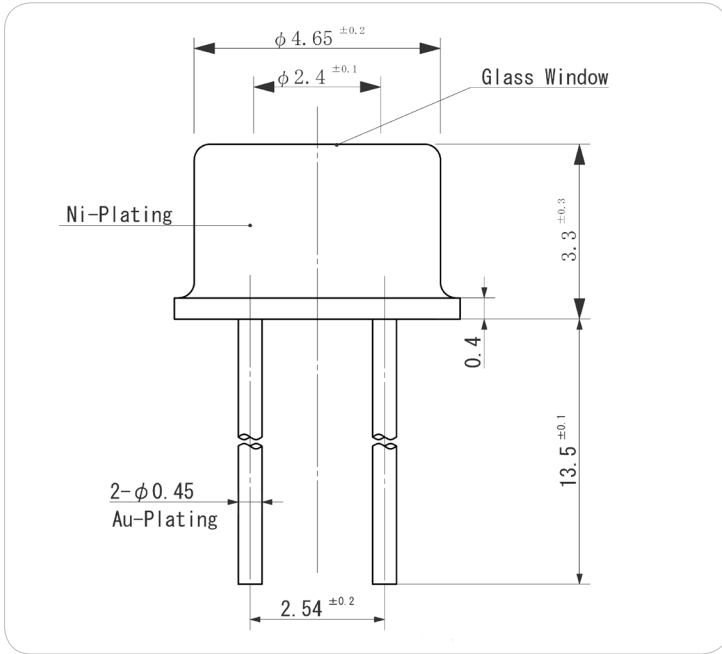

Unit: mm, Tolerance: ± 0.2

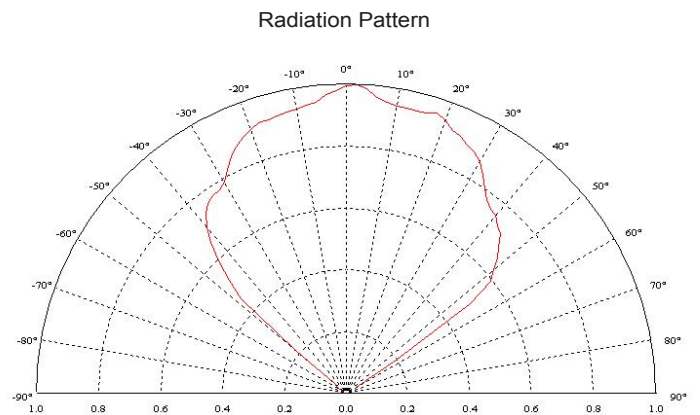
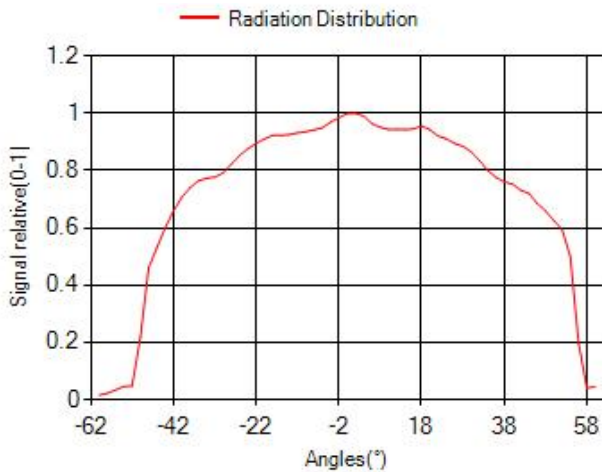
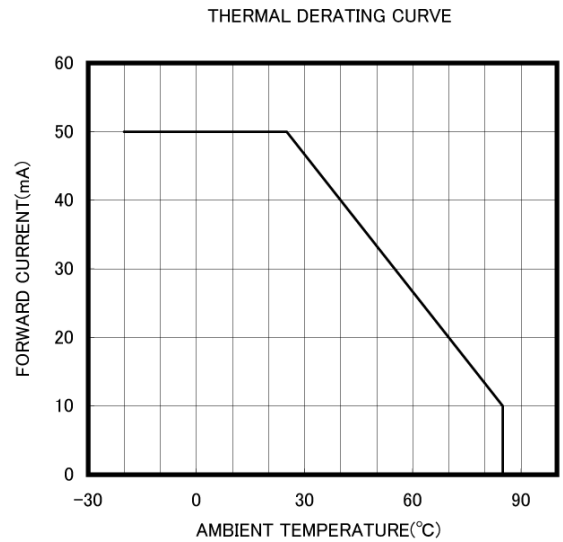
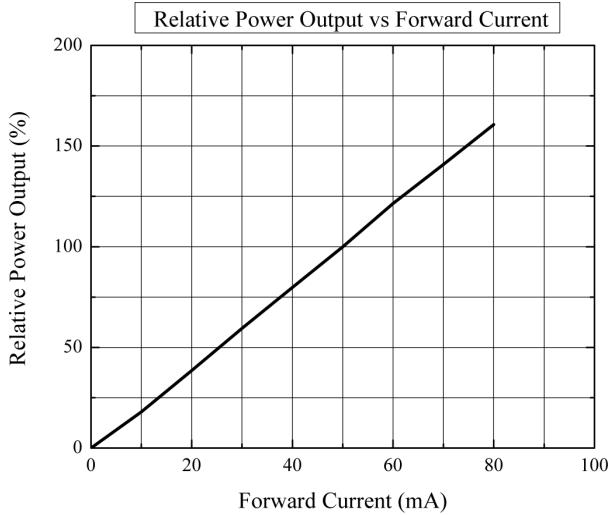

The information contained herein is subject to change without notice.

2018-07-12

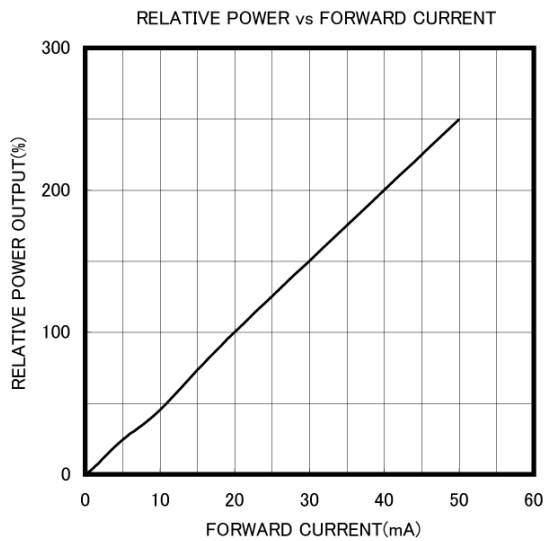

The information contained herein is subject to change without notice.

2018-07-12