

Magnetically Compensated Choke, 1-phase, high design



See below:

**Approvals and Compliances**

**Description**

- Current compensated choke
- 1-phase choke
- THT-terminals
- Inductor vertically positioned in housing

**Applications**

- Attenuation of common mode interferences
- Designed for 230/400 VAC applications
- Chopper amplifiers
- DC drives and stepper motor controls
- Switching power supplies

**Weblinks**

[pdf data sheet](#), [html datasheet](#), [General Product Information](#), [Approvals](#), [Distributor-Stock-Check](#), [Detailed request for product](#), [SPICE Library](#)

**Technical Data**

Rated voltage	up to 440 VAC	Test Voltage	1.8kV, 50Hz, 1 min, winding to winding
	UL 250 VAC	Isolation Voltage	2kV eff., winding to ambient
Rated Current	0.6 - 6.3 A @ Ta 40 °C	Climatic Category	25/100/21 acc. to IEC 60068-1
Rated inductance	0.6 - 50mH, Tol. -30% +50%	Allowable Operation Temp.	-25 °C to 100 °C
Power Operating Frequency	50 / 60Hz		
Terminal Type	THT		
Weight	3 - 30g		
Material	UL 94V-0		
Sealing Compound	UL 94V-0		

**Approvals and Compliances**

Detailed information on product approvals, code requirements, usage instructions and detailed test conditions can be looked up in [Details about Approvals](#)

SCHURTER products are designed for use in industrial environments. They have approvals from independent testing bodies according to national and international standards. Products with specific characteristics and requirements such as required in the automotive sector according to IATF 16949, medical technology according to ISO 13485 or in the aerospace industry can be offered exclusively with customer-specific, individual agreements by SCHURTER.

**Approvals**

The approval mark is used by the testing authorities to certify compliance with the safety requirements placed on electronic products.

Approval Reference Type: DFKH

Approval Logo	Certificates	Certification Body	Description
	<a href="#">UL Approvals</a>	UL	UR File Number: E72928





**Application standards**

Application standards where the product can be used

Organization	Design	Standard	Description
	Suitable for applications acc.	IEC/UL 62368-1	Audio/video, information and communication technology equipment - Part 1: Safety requirements

**Compliances**

The product complies with following Guide Lines

Identification	Details	Initiator	Description
	<a href="#">CE declaration of conformity</a>	SCHURTER AG	The CE marking declares that the product complies with the applicable requirements laid down in the harmonisation of Community legislation on its affixing in accordance with EU Regulation 765/2008.
	<a href="#">UKCA declaration of conformity</a>	SCHURTER AG	The UKCA marking declares that the product complies with the applicable requirements laid down in the British Amendment of Regulation (EC) 765/2008.
	RoHS	SCHURTER AG	Directive RoHS 2011/65/EU, Amendment (EU) 2015/863
	China RoHS	SCHURTER AG	The law SJ / T 11363-2006 (China RoHS) has been in force since 1 March 2007. It is similar to the EU directive RoHS.
	REACH	SCHURTER AG	On 1 June 2007, Regulation (EC) No 1907/2006 on the Registration, Evaluation, Authorization and Restriction of Chemicals 1 (abbreviated as "REACH") entered into force.

**Dimension [mm]**

Case 50-2, 51-2, 52-2

Case 09-2

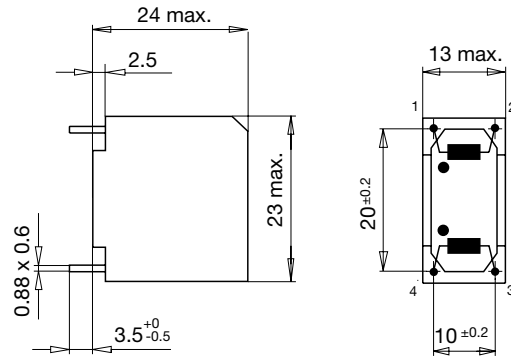
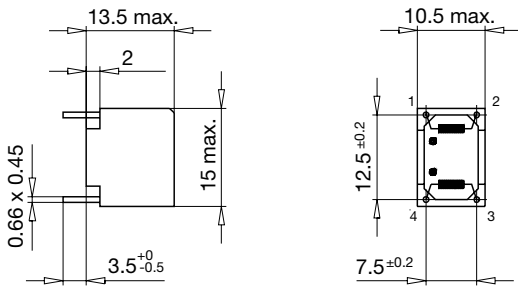

Case 19-2

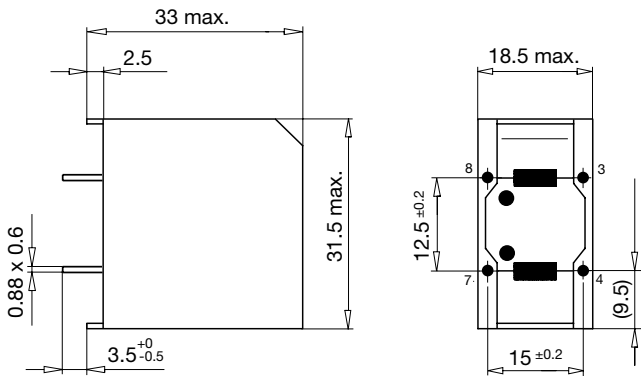

Impedance curves

DFKH-31-xxxx

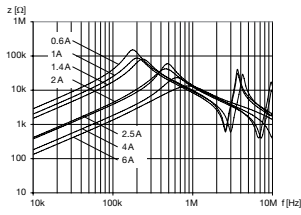

DFKH-22-xxxx

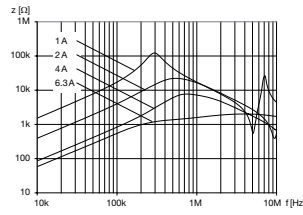

DFKH-14-xxxx

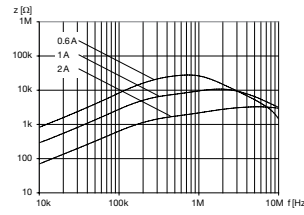

All Variants

$I_n$ [A]	$L_n$ [mH]	$R_{cu}$ [mΩ]	Tripped Power Dissipation [W]	$f_{RES}$ [MHz]	Weight [g]	Housing	Packing unit [pcs.]	Order Number
0.6	11	600	0.5	0.5	3 g	50-2	100	DFKH-14-0001
0.6	50	1200	0.9	0.15	22 g	19-2	70	DFKH-31-0001
1	20	500	1	0.25	10 g	09-2	50	DFKH-22-0002
1	33	700	1.4	0.25	30 g	19-2	70	DFKH-31-0002
1	4	250	0.5	1.2	3 g	51-2	100	DFKH-14-0002
1.4	27	470	1.8	0.3	30 g	19-2	70	DFKH-31-0003
2	1	65	0.5	2.5	3 g	52-2	100	DFKH-14-0003
2	6	150	1.3	0.6	10 g	09-2	50	DFKH-22-0003
2	6.8	150	1.2	0.5	30 g	19-2	70	DFKH-31-0005
2.5	5.6	110	-	-	30 g	19-2	70	DFKH-31-0006
4	1.5	36	1.2	1.5	10 g	09-2	50	DFKH-22-0004
4	3.3	58	1.8	0.8	30 g	19-2	70	DFKH-31-0007
6	2	24	1.8	1.2	30 g	19-2	70	DFKH-31-0008
6.3	0.6	15	1.4	2.5	10 g	09-2	50	DFKH-22-0005

Most Popular.

Availability for all products can be searched real-time: <https://www.schurter.com/en/Stock-Check/Stock-Check-SCHURTER>