

0.5 W Ka-Band Power Amplifier 27 - 31.5 GHz



MAAP-011341

Rev. V2

Features

- 28 dB Gain
- 36 dBm Output IP3
- 27 dBm P1dB
- 28 dBm P3dB
- 5.5 V Drain Supply
- 4 mm, 24 lead AQFN Package
- RoHS* Compliant

Applications

- Satellite Communications

Description

The MAAP-011341 is a 1/2 W Ka-band power amplifier. The PA has a 27 dBm typical P1dB and a 28 dBm typical P3dB with 28 dB of gain. The drain bias supply is 5.5 V. The gate voltage is adjusted to set the drain current to 450 mA.

The MAAP-011341 is designed for medium power applications in the 27 - 31.5 GHz band. The 4 mm, 24 lead AQFN package is lead free and RoHS compliant.

It is also available as a bare DIE product under part number MAAP-011341-DIE.

Ordering Information

Part Number	Package
MAAP-011341-TR1000	1000 Piece Reel
MAAP-011341-TR3000	3000 Piece Reel
MAAP-011341-SMB	Sample Board

Block Diagram

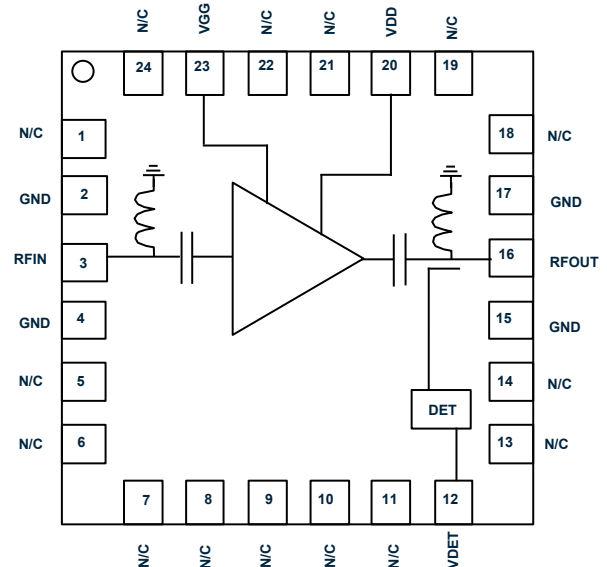

Pin Configuration^{1,2}

Pin #	Pin Name	Description
1,5-11, 13, 14, 18, 19, 21, 22, 24	N/C	No Connect
2,4,15,17	GND	Ground
3	RF _{IN}	RF Input
12	V _{DET}	Detector Voltage
16	RF _{OUT}	RF Output
20	V _{DD}	Drain Voltage
23	V _{GG}	Gate Voltage

1. It is recommended that all NC (No Connect) pins be grounded.
2. The exposed pad centered on the package bottom must be connected to RF, DC, and thermal ground.

* Restrictions on Hazardous Substances, compliant to current RoHS EU directive.

0.5 W Ka-Band Power Amplifier

27 - 31.5 GHz



MAAP-011341

Rev. V2

Electrical Specifications: $V_{DD} = +5.5\text{ V}$, $IDQ = 450\text{ mA}$, $T_A = 25^\circ\text{C}$, $Z_0 = 50\ \Omega$

Parameter	Test Conditions	Units	Min.	Typ.	Max.
Gain	27 - 31.5 GHz	dB	24.5	28	—
Gain Flatness	27 - 31.5 GHz	dB	—	0.5	—
Input Return Loss	27 - 31.5 GHz	dB	—	10	—
Output Return Loss	27 - 31.5 GHz	dB	—	10	—
P1dB	27 - 31.5 GHz	dBm	—	27	—
P3dB	27 - 31.5 GHz	dBm	—	28	—
P_{OUT}	27 GHz, $P_{IN} = 4.0\text{ dBm}$ 31.5 GHz, $P_{IN} = 3.5\text{ dBm}$	dBm	26.5 26.0	28.0 27.5	—
IP3	27 - 31.5 GHz, $P_{OUT} = 16\text{ dBm/}$ tone 10 MHz	dBm	—	36	—
Noise Figure	27 - 31.5 GHz	dB	—	5	—
V_{DET}	3 dBm Output Power 27 dBm Output Power	V	—	0.1 1.5	—

Maximum Operating Conditions

Parameter	Maximum
Input Power	8 dBm
V_{DD}	+6 V
V_{GG}	-3 to 0 V
Junction Temperature ^{3,4}	+160°C
Operating Temperature	-40°C to +85°C

- Operating at nominal conditions with $T_J \leq +160^\circ\text{C}$ will ensure $MTTF > 1 \times 10^6$ hours.
- TX Junction Temp. (T_J) = $T_C + \Theta_{jc} * ((V * I) - (P_{OUT} - P_{IN}))$.
Typical TX thermal resistance (Θ_{jc}) = 29.3°C/W.
 - For $T_C = +85^\circ\text{C}$ and 31 GHz,
 $T_J = 148^\circ\text{C}$ @ 5.5 V, 460 mA, $P_{OUT} = 26\text{ dBm}$, $P_{IN} = 4.5\text{ dBm}$
 - For $T_C = +25^\circ\text{C}$ and 31 GHz,
 $T_J = 83^\circ\text{C}$ @ 5.5 V, 460 mA, $P_{OUT} = 27.5\text{ dBm}$, $P_{IN} = 3.5\text{ dBm}$

Bias Sequence

All gate voltages must be applied prior to applying drain voltages.

- Apply V_{GG} (about -1.5 V) to pin 23.
- Apply V_{DD} (+5.5 V) to pin 20.
- Adjust V_{GG} to set IDQ to 450 mA.

Shut down by setting $V_{DD} = 0\text{ V}$ first.

Absolute Maximum Ratings^{5,6}

Parameter	Absolute Maximum
Input Power	10 dBm
V_{DD}	+6.5 V
V_{GG}	-5 to 0 V
Junction Temperature ⁷	+180°C
Storage Temperature	-55°C to +150°C

- Exceeding any one or combination of these limits may cause permanent damage to this device.
- MACOM does not recommend sustained operation near these survivability limits.
- Junction temperature directly effects device MTTF. Junction temperature should be kept as low as possible to maximize lifetime.

Handling Procedures

Please observe the following precautions to avoid damage:

Static Sensitivity

These electronic devices are sensitive to electrostatic discharge (ESD) and can be damaged by static electricity. Proper ESD control techniques should be used when handling these HBM Class 1B devices.

2

Application Schematic

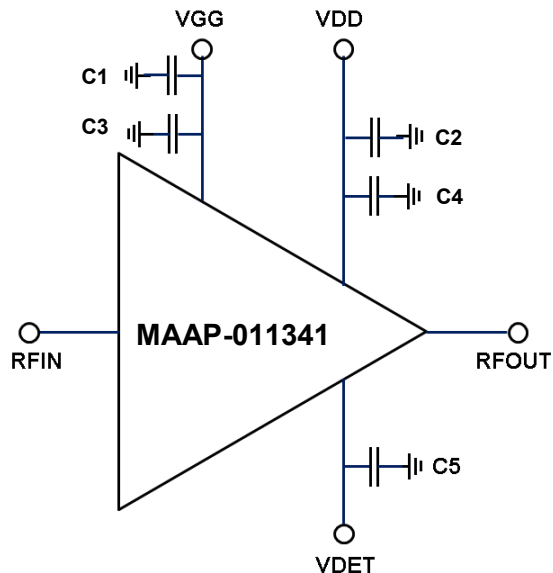

PCB Layout Stack-Up

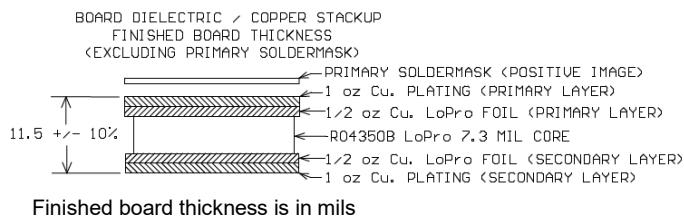

Sample Board Layout

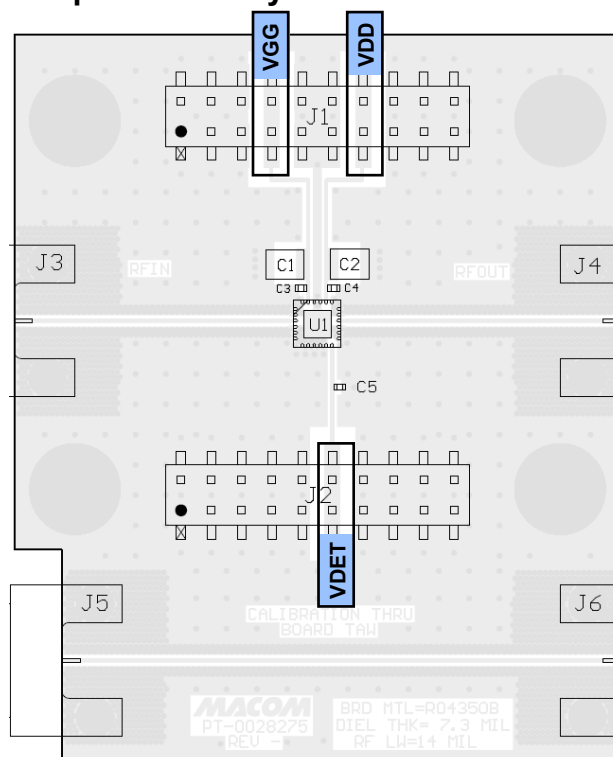

Parts List

Part #	Value	Case Style
C1, C2	10 μ F	1210
C3, C4	1000 pF	0402
C5	1 μ F	0402
J1, J2	100-mil pitch double row DC header	
J3 - J6	Southwest 2.4 mm, 5 mil pin diameter	

Recommended PCB Information

RF input and output are 50 Ω transmission lines on single layer 7.3 mil Rogers RO4350B LoPro with 1.5 oz. Cu. For best thermal management, use as many copper filled vias under the device as physically possible. The filled vias should be plated over. 8 mil diameter vias in a 5 x 5 array are used on this sample board.

Sample Board Thru Line Loss

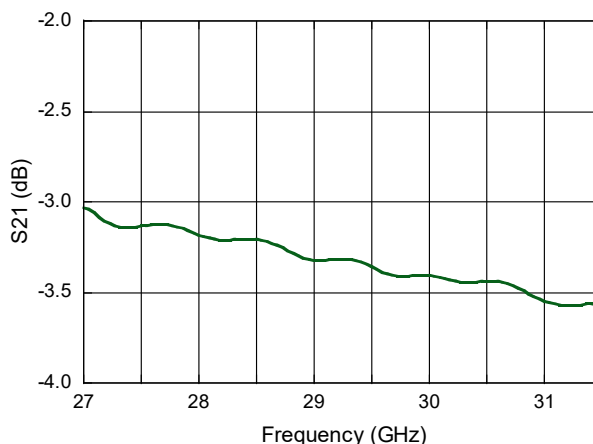

0.5 W Ka-Band Power Amplifier 27 - 31.5 GHz



MAAP-011341
Rev. V2

Typical Performance Curves: $V_{DD} = 5.5 \text{ V}$, $I_{DQ} = 450 \text{ mA}$

Small Signal Gain vs. Frequency over Temperature

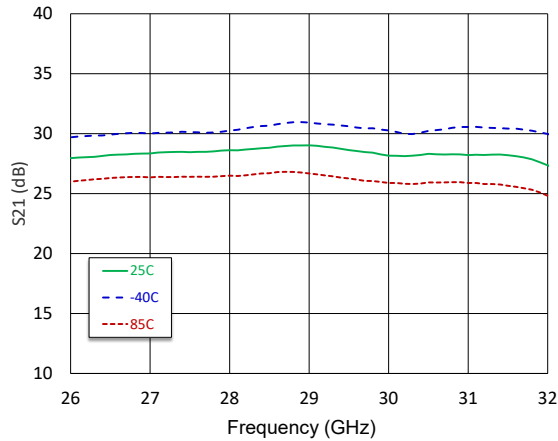

Small Signal Gain vs. Frequency over Bias Current

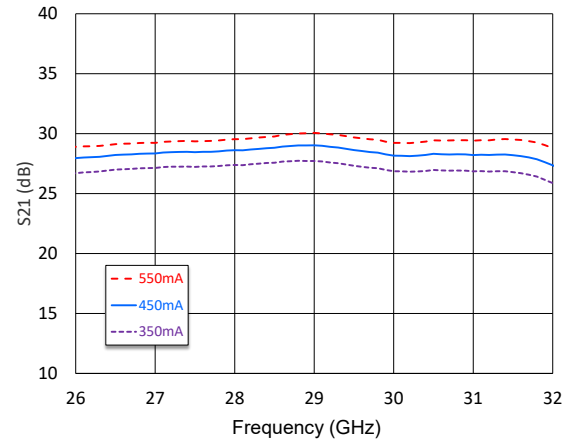

Input Return Loss vs. Frequency over Temperature

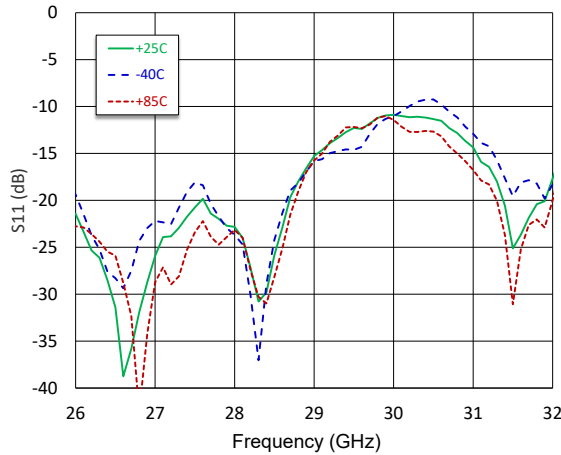

Input Return Loss vs. Frequency over Bias Current

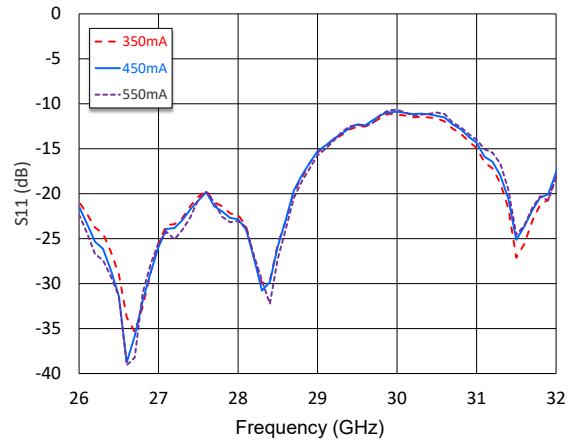

Output Return Loss vs. Frequency over Temperature

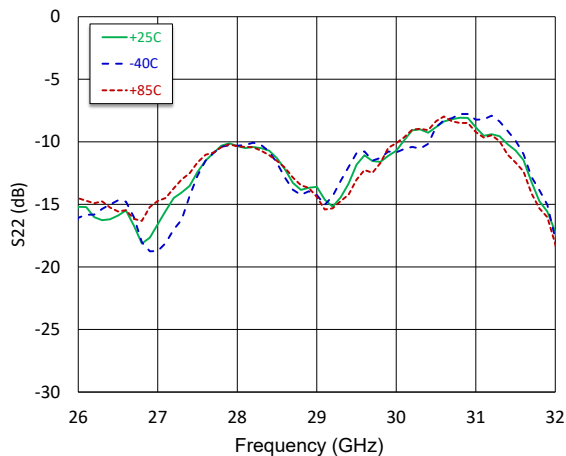

Output Return Loss vs. Frequency over Bias Current

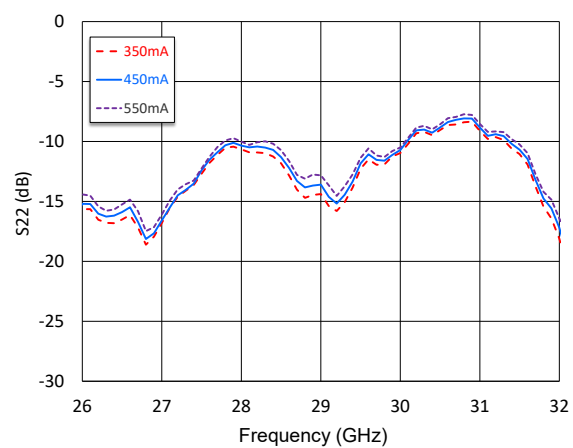

0.5 W Ka-Band Power Amplifier 27 - 31.5 GHz



MAAP-011341

Rev. V2

Typical Performance Curves: $V_{DD} = 5.5 \text{ V}$, $I_{DQ} = 450 \text{ mA}$

***P*3dB vs. Frequency over Temperature**

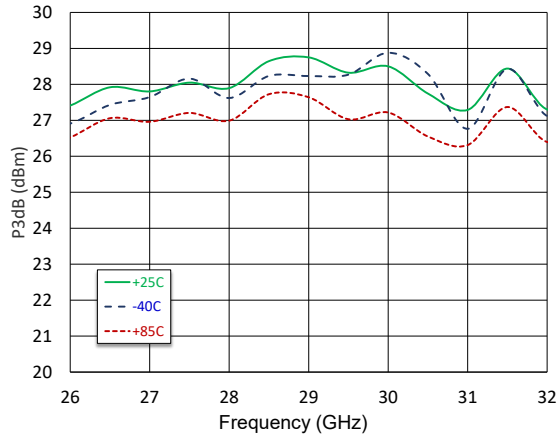

***P*3dB vs. Frequency over Bias Current**

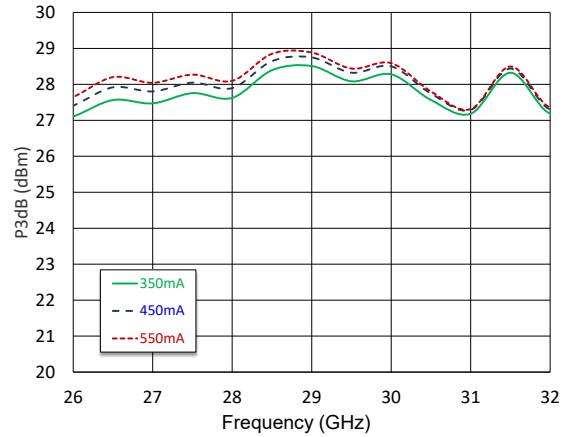

***P*1dB vs. Frequency over Temperature**

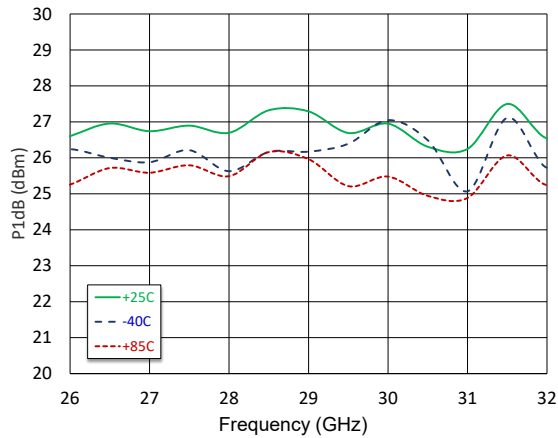

***P*1dB vs. Frequency over Bias Current**

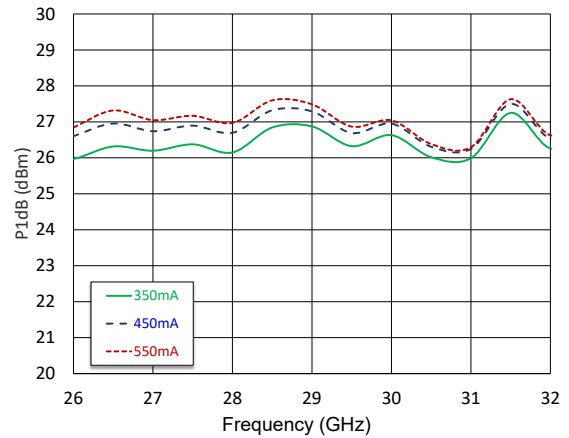

0.5 W Ka-Band Power Amplifier 27 - 31.5 GHz



MAAP-011341
Rev. V2

Typical Performance Curves: $V_{DD} = 5.5 \text{ V}$, $I_{DQ} = 450 \text{ mA}$

Output IP3 vs. Frequency over Temperature @ 27 GHz

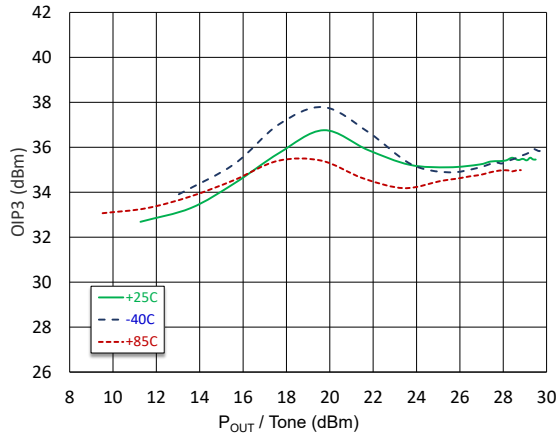

Output IP3 vs. Frequency over Temperature @ 29 GHz

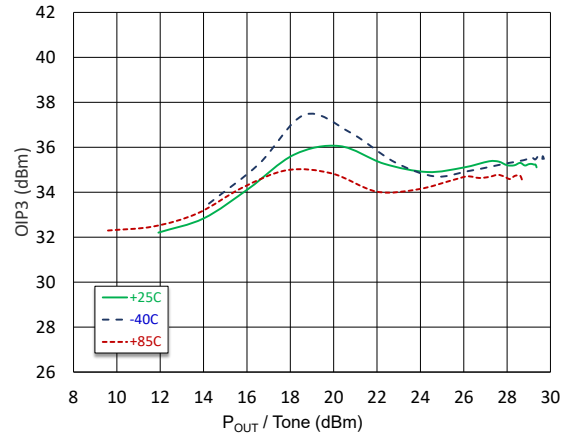

Output IP3 vs. Frequency over Temperature @ 31 GHz

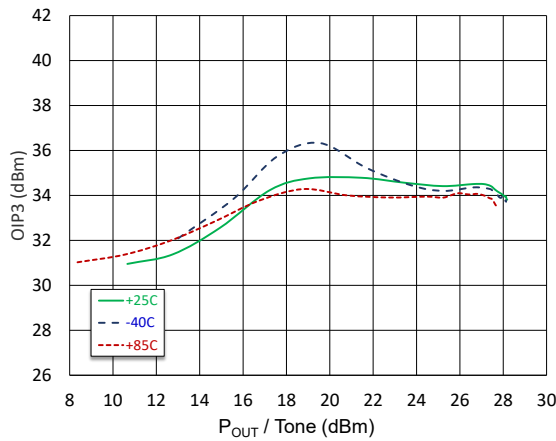

Output IP3 vs. Frequency over Temperature @ 19 dBm/TONE

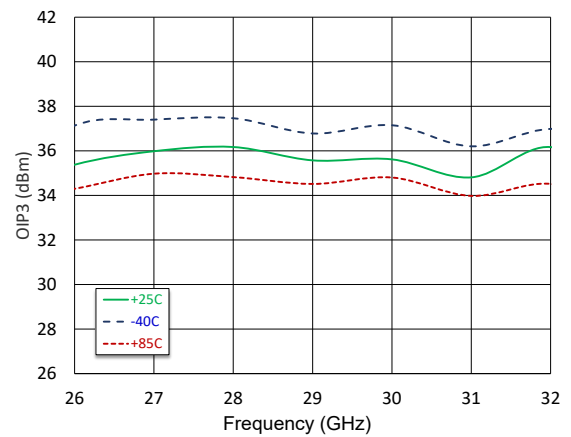

0.5 W Ka-Band Power Amplifier 27 - 31.5 GHz



MAAP-011341
Rev. V2

Typical Performance Curves: $V_{DD} = 5.5 \text{ V}$, $I_{DQ} = 450 \text{ mA}$

Noise Figure vs. Frequency over Temperature

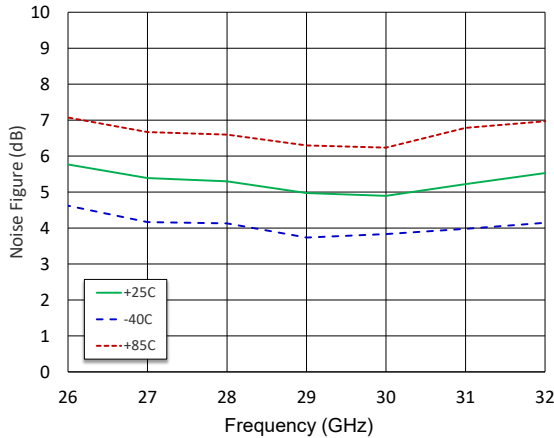

Detector Voltage vs. Output Power

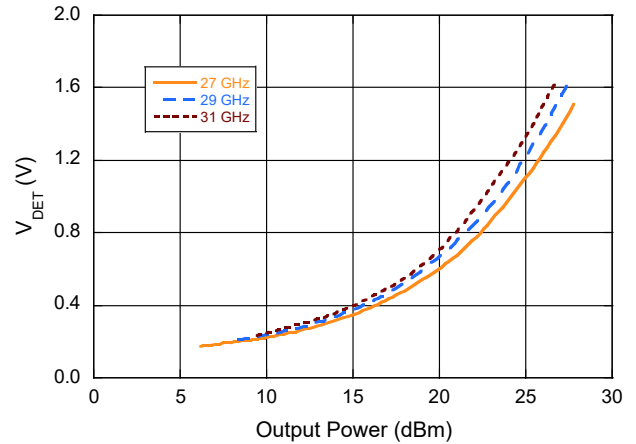

Drain Current vs Output Power

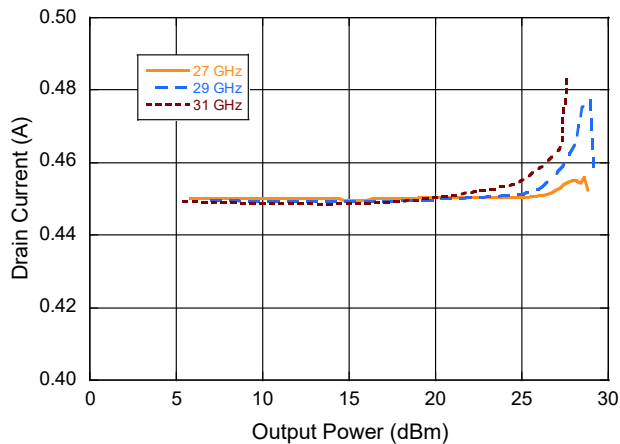

Gate Current vs Output Power

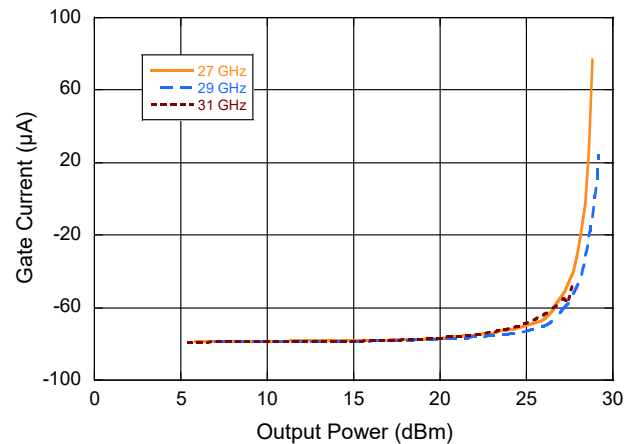

PAE vs Input Power

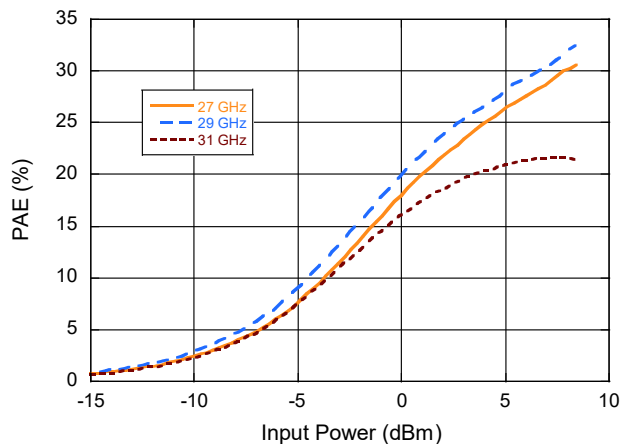

0.5 W Ka-Band Power Amplifier 27 - 31.5 GHz



MAAP-011341

Rev. V2

Lead-Free 4 mm 24-Lead AQFN Package[†]

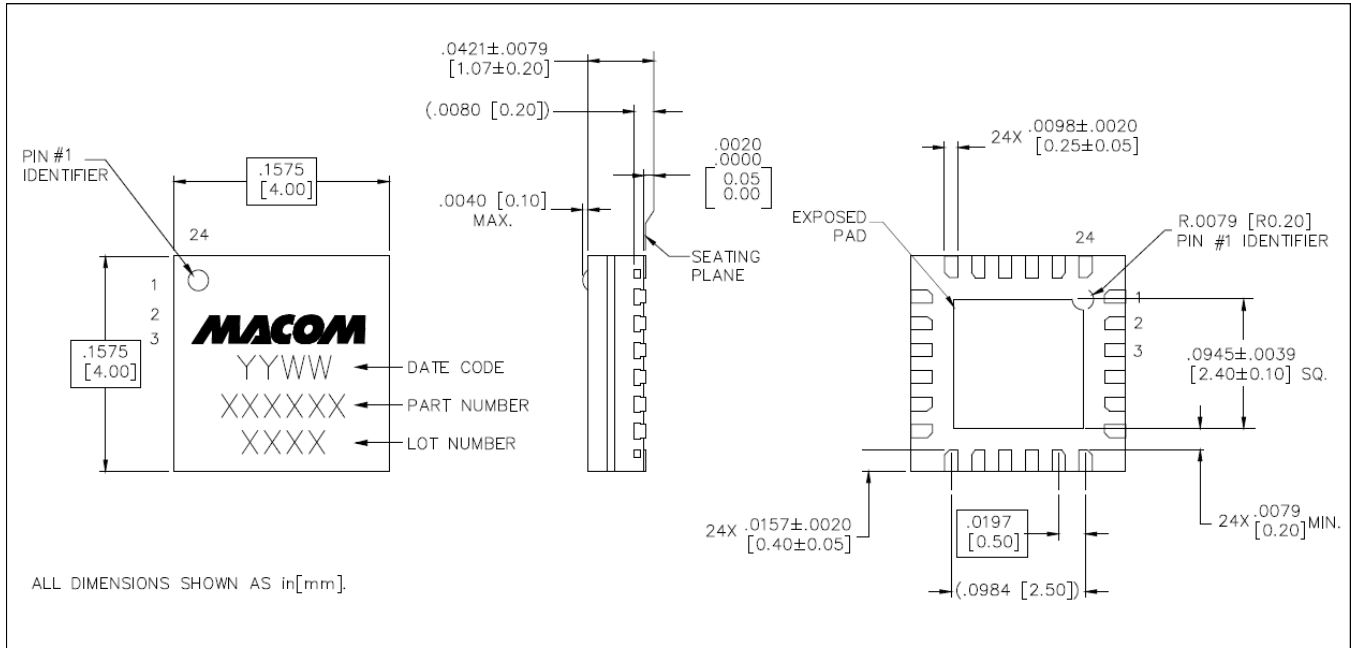

[†] Reference Application Note S2083 for lead-free solder reflow recommendations.
Meets JEDEC moisture sensitivity level 3 requirements.
Plating is NiPdAu

0.5 W Ka-Band Power Amplifier 27 - 31.5 GHz



MAAP-011341

Rev. V2

MACOM Technology Solutions Inc. ("MACOM"). All rights reserved.

These materials are provided in connection with MACOM's products as a service to its customers and may be used for informational purposes only. Except as provided in its Terms and Conditions of Sale or any separate agreement, MACOM assumes no liability or responsibility whatsoever, including for (i) errors or omissions in these materials; (ii) failure to update these materials; or (iii) conflicts or incompatibilities arising from future changes to specifications and product descriptions, which MACOM may make at any time, without notice. These materials grant no license, express or implied, to any intellectual property rights.

THESE MATERIALS ARE PROVIDED "AS IS" WITH NO WARRANTY OR LIABILITY, EXPRESS OR IMPLIED, RELATING TO SALE AND/OR USE OF MACOM PRODUCTS INCLUDING FITNESS FOR A PARTICULAR PURPOSE, MERCHANTABILITY, INFRINGEMENT OF INTELLECTUAL PROPERTY RIGHT, ACCURACY OR COMPLETENESS, OR SPECIAL, INDIRECT, INCIDENTAL, OR CONSEQUENTIAL DAMAGES WHICH MAY RESULT FROM USE OF THESE MATERIALS.

MACOM products are not intended for use in medical, lifesaving or life sustaining applications. MACOM customers using or selling MACOM products for use in such applications do so at their own risk and agree to fully indemnify MACOM for any damages resulting from such improper use or sale.