

1W NATURAL CONVECTION

DC-DC POWER SUPPLIES

The single output IES01 series is an ideal solution for isolating voltage rails in a distributed power supply architecture such as analog, digital, data and relay circuits. This product family offers a compact design with high efficiency, 1.5kV isolation with 3.0kV optional, short circuit protection and high operating temperature.



Features

- Unregulated single output
- $\pm 10\%$ input range
- Single outputs 3.3 to 24VDC
- SMD8 DIP package
- Industry standard pinout
- 1.5kVDC isolation, 3kVDC option
- UL62368-1 safety approvals
- Continuous short circuit protection
- Tape & reel option
- Operating temperature -40°C to $+105^{\circ}\text{C}$
- Full load to 100°C
- 3 year warranty

Applications



Industrial Electronics



Instrumentation



Technology

Dimensions

0.52" x 0.335" x 0.285" (13.2 x 8.5 x 7.25 mm)

Models & Ratings

Model Number ^(5,6)	Input Voltage	Output Voltage	Input Current ⁽¹⁾		Output Current		Maximum Capacitive Load	Efficiency ⁽²⁾
			No Load	Full Load	Minimum	Maximum		
IES0105S03	5V (4.5-5.5V)	3.3V	5mA	270mA	30mA	303mA	2400 μ F	74%
IES0105S05		5V	5mA	270mA	20mA	200mA	2400 μ F	82%
IES0105S06 ⁽³⁾		6V	5mA	270mA	17mA	167mA	2400 μ F	82%
IES0105S09		9V	12mA	241mA	12mA	111mA	1000 μ F	83%
IES0105S12		12V	12mA	241mA	9mA	84mA	560 μ F	83%
IES0105S15		15V	18mA	241mA	7mA	67mA	560 μ F	83%
IES0105S24		24V	18mA	241mA	4mA	42mA	220 μ F	85%
IES0112S05	12V (10.8 - 13.2V)	5V	8mA	107mA	20mA	200mA	2400 μ F	82%
IES0112S09		9V	8mA	106mA	12mA	111mA	1000 μ F	83%
IES0112S12		12V	8mA	106mA	9mA	84mA	560 μ F	83%
IES0112S15		15V	8mA	106mA	7mA	67mA	560 μ F	83%
IES0112S24		24V	8mA	103mA	4mA	42mA	220 μ F	85%
IES0115S05	15V (13.5-16.5V)	5V	8mA	86mA	20mA	200mA	2400 μ F	82%
IES0115S15		15V	8mA	85mA	7mA	67mA	560 μ F	83%
IES0124S05		5V	8mA	55mA	20mA	200mA	2400 μ F	82%
IES0124S09	24V (21.6 - 26.4V)	9V	8mA	55mA	12mA	111mA	1000 μ F	83%
IES0124S12		12V	8mA	55mA	9mA	84mA	560 μ F	83%
IES0124S15		15V	8mA	55mA	7mA	67mA	560 μ F	83%
IES0124S24		24V	8mA	53mA	4mA	42mA	220 μ F	85%

Notes:

1. Typical input currents measured at nominal input voltage.
2. Typical value at full load.
3. 6V model 1.5kV isolation only. Designed to meet UL62368-1.

4. Standard tube quantity = 38.
5. For tape & reel option add suffix -TR. Reel quantity = 500.
6. Optional 3kVDC isolation add suffix '-H'.

Input

Characteristic	Minimum	Typical	Maximum	Units	Notes & Conditions
Input Voltage	4.5		26.4	VDC	See models and ratings table
Input Reflected Ripple		15/30	63	mA pk-pk	Through 4.7μH inductor and 220μF capacitor, 5V input/other models
Input Surge			9	VDC	IES0105 for max 1s
			18		IES0112 for max 1s
			21		IES0115 for max 1s
			30		IES0124 for max 1s
Input Current	See models and ratings table				
Input Filter	Capacitor				

Output

Characteristic	Minimum	Typical	Maximum	Units	Notes & Conditions
Output Voltage	3.3		24	VDC	See models and ratings table
Initial Set Accuracy	See Load Regulation curves				
Minimum Load	10			%	
Line Regulation			±1.2	%	Per ±1% change of input voltage
Load Regulation	See Load Regulation curves				
Ripple and Noise		30 (50)	75 (100)	mV pk-pk	For models ≤15V/24V output, 20 MHz bandwidth, measured using 0.1μF capacitor
Short Circuit Protection	Continuous, with auto recovery				
Maximum Capacitive Load	See Models and Ratings table				
Temperature Coefficient			±0.02	%/°C	

General

Characteristic	Minimum	Typical	Maximum	Units	Notes & Conditions
Efficiency	See Models and Ratings table				
Isolation: Input to Output	1500/3000			VDC	IES/IES-H functional
Switching Frequency	260	270	278	kHz	Low input voltage 10% load to high input voltage at full load
Isolation Resistance	10 ⁹			Ω	Input to output, tested at 500VDC
Isolation Capacitance		20		pF	Input to output
Power Density			20.8	W/in ³	
Mean Time Between Failure	3500			khrs	MIL-HDBK-217F, 25°C GB.
Weight		0.003 (1.4)		lb(g)	
Recommended Solder Profile	IPC/JEDEC J-STD-020D.1, peak temp ≤245°C, max duration, ≤60s at 217°C				
MSL	Level 1				
Case Material	Black plastic, flame retardant UL94V-0				
Pin Material	Phosphor bronze, solder coated				
Water Wash	Non-soaking water wash with de-ionised water. Dry thoroughly.				

Mechanical Details

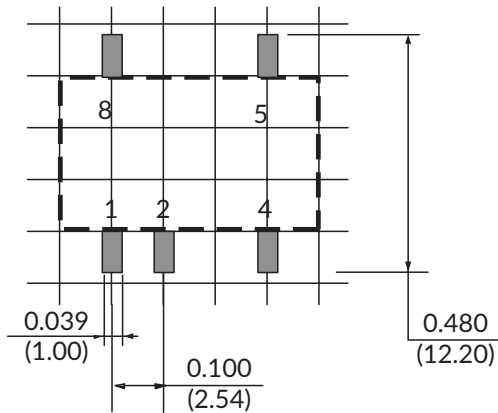
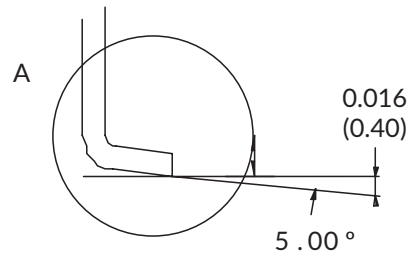
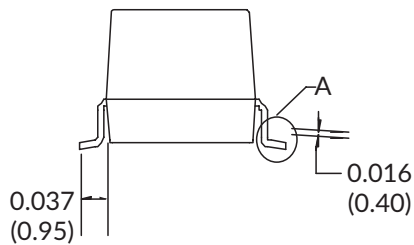
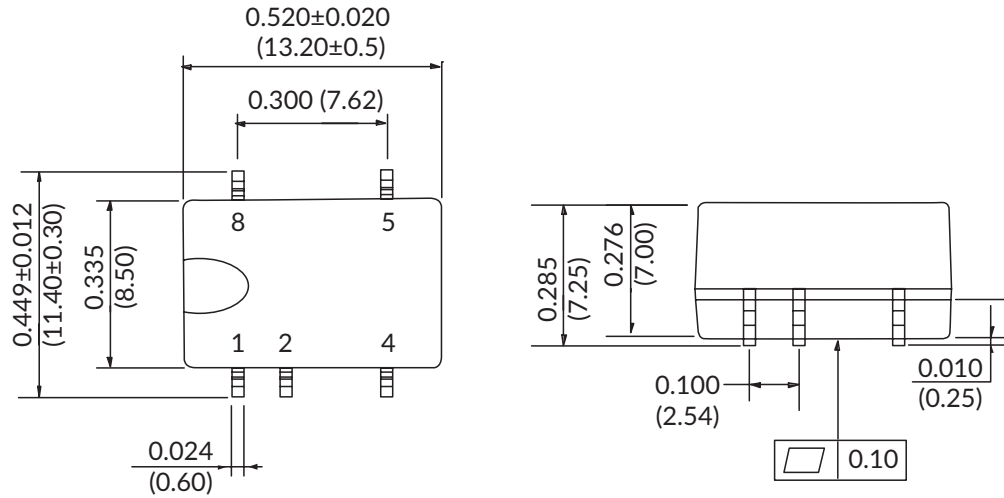

Pin Connections	
Pin	Function
1	-Vin
2	+Vin
4	-Vout
5	+Vout
8	No Connection ⁽⁵⁾

Recommended Footprint
 Top View grid: 0.1 x 0.1 in (2.54 x 2.54 mm)

Notes:

1. All dimensions are in inches (mm).
2. Weight: 0.003lbs (1.4g) typical.
3. Pin pitch and length tolerance: ± 0.004 (± 0.10).
4. Case tolerance: ± 0.02 (± 0.5).
5. Pin 8 leave floating.

Environmental

Characteristic	Minimum	Typical	Maximum	Units	Notes & Conditions
Operating Temperature	-40		+105	°C	Derate from 100% load at +100°C to 80% load at 105°C
Storage Temperature	-55		+125	°C	
Case Temperature			+105	°C	
Case Temperature Rise		25/15		%RH	Ambient 25°C , 3V3 output/others
Operating Humidity			95	m	Non-condensing
Cooling	Natural convection				

Safety Approvals

Safety Agency	Standard	Notes & Conditions
UL	UL62368-1	
CE	Meets all applicable directives	
UKCA	Meets all applicable legislation	

EMC: Emissions

Phenomenon	Standard	Test Level	Notes & Conditions
Conducted	EN55032	Class B	See Application Note for Class B filter
Radiated	EN55032	Class B	

EMC: Immunity

Phenomenon	Standard	Test Level	Criteria	Notes & Conditions
ESD Immunity	EN61000-4-2	±4kV contact / ±8kV air discharge	B	

Load Regulation

5V input series

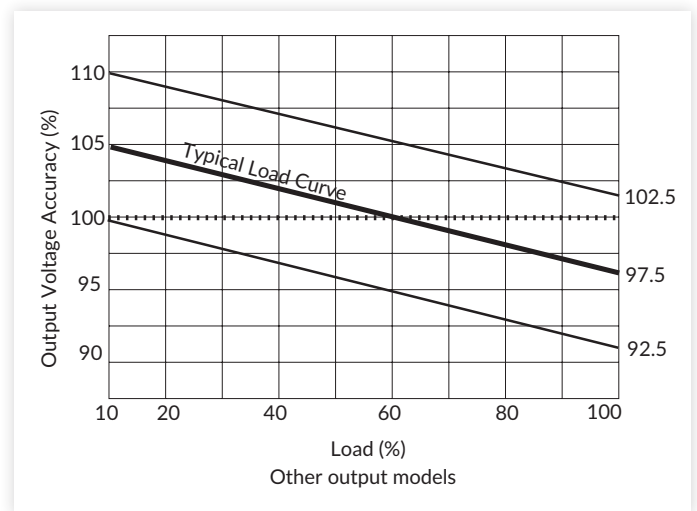
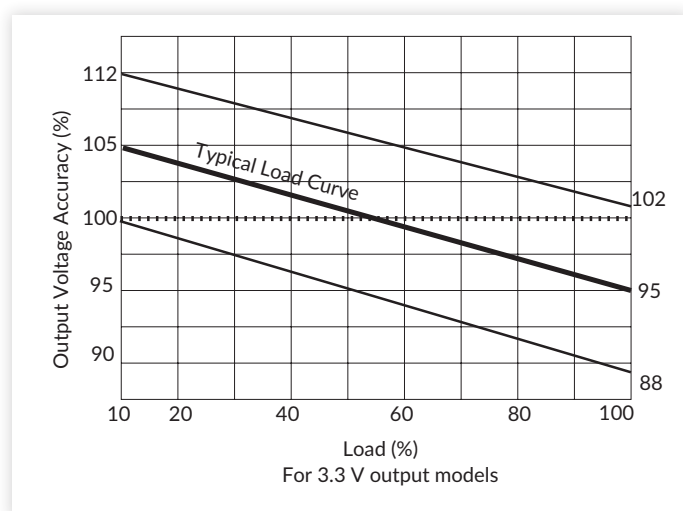

Application Notes

Other Input Series

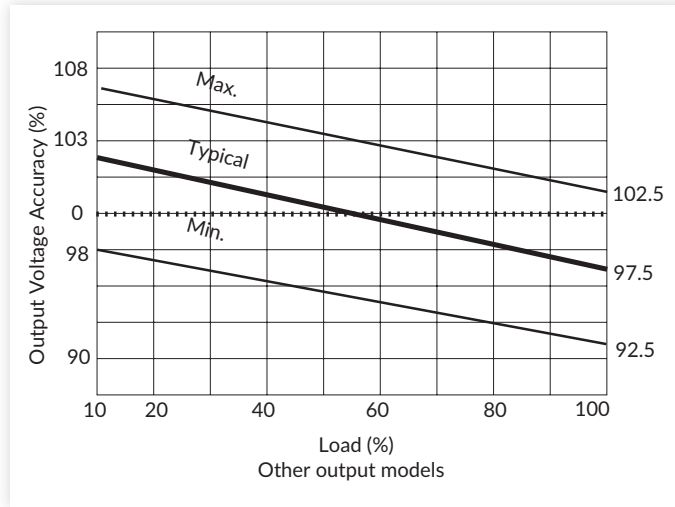

EMI Filter for Class B Emissions

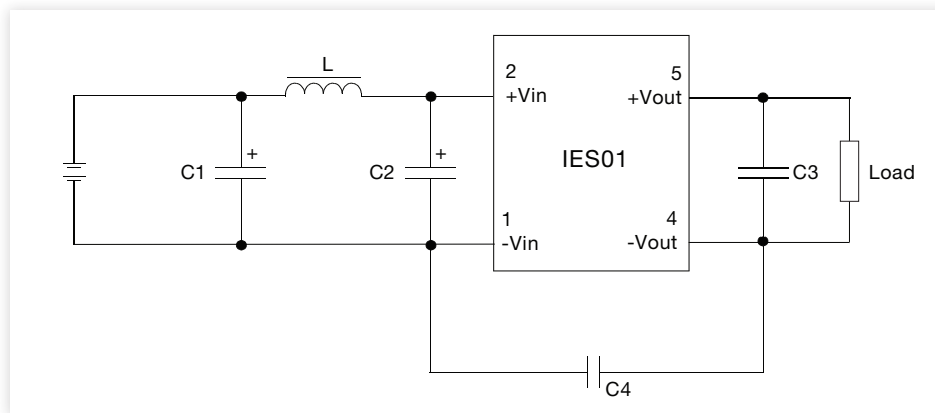

5V Input:

Output Voltage	C1, C2	C3	C4	L
3.3V	4.7μF, 25V	10μF, 16V	Not fitted	6.8μH
5V		10μF, 16V		
9V		2.2μF, 25V		
12V		2.2μF, 25V	1nF	
15V		1μF, 25V		
24V		0.47μF, 50V		

C4: 2kV, ceramic. Upgrade C4 to 4kV for 3kV isolation option -H.

Other Input Series:

Output Voltage	C1, C2	C3	C4	L
5V	4.7μF, 50V	10μF, 16V	270pF	6.8μH
9V		2.2μF, 16V		
12V		2.2μF, 25V		
15V		1μF, 25V		
24V		1μF, 50V		

C4: 2kV, ceramic. Upgrade C4 to 4kV for 3kV isolation option -H.

Application Notes

Temperature Derating Curve

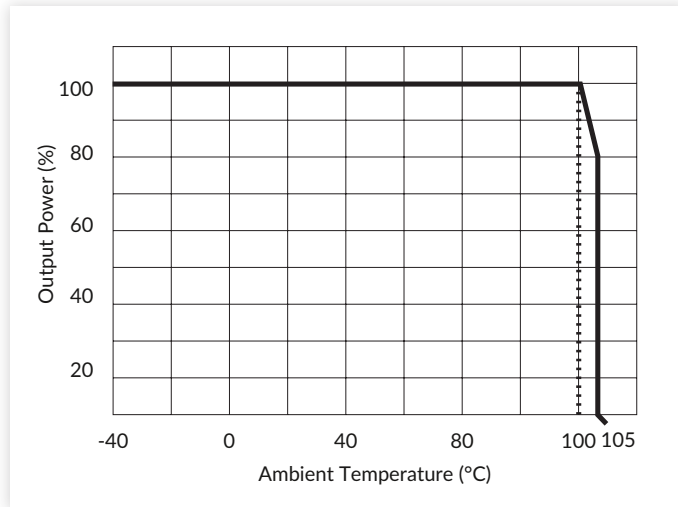

Efficiency vs Input Voltage (IES0105S05)

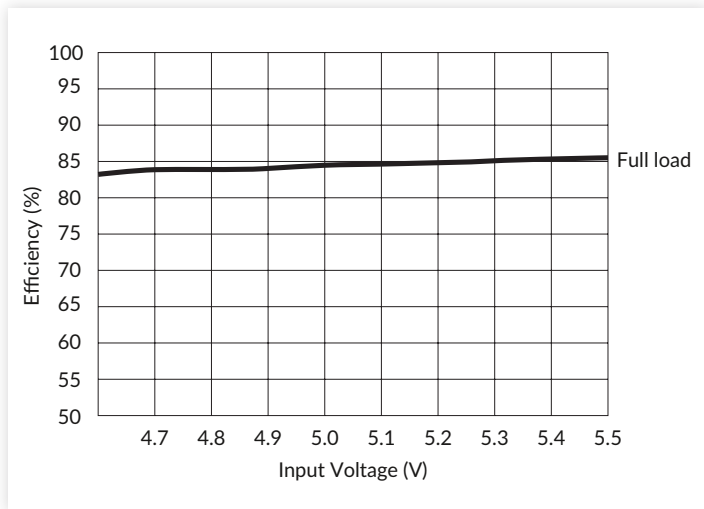

Efficiency vs Output Load (IES0105S05)

