

Bookstyle EMC/EMI Filter for Motor Drives

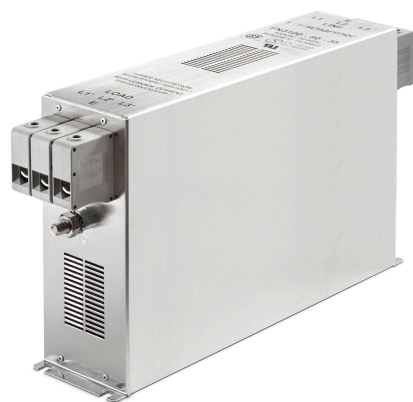

- Exceptional broadband attenuation performance from 10 kHz up to 30 MHz
- Slim and user-friendly book-style design with touch-safe terminal blocks for minimum space and maximum safety
- Enables compliance with Class B limits

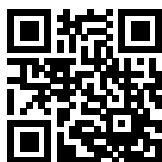

Performance indicators

Attenuation performance



Rated current [A]

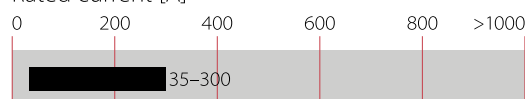

Approvals & Compliances



(FN3100 up to 150 A)

Features and Benefits

- High performance filter for mainly industrial motor drive applications with significant interference levels
- Attenuation performance for Class B compliance in applications comprising multiple motor drives (e.g. machine tool with up to 8 driving axes with ~10 to 20 m motor cable each)
- Broadband filter performance with low frequency attenuation down to 10 kHz for reliable suppression of conducted interference
- Slim book-style shape requiring minimum cabinet space and allowing convenient installation right beside the motor drive
- Touch-safe terminal blocks provide unsurpassed electrical safety and contacting cross section according to EN 60204-1 installation standard
- For even better filter specifications, please consider FN 3120 H series from Schaffner

Technical Specifications

Maximum continuous operating voltage	3x 520/300 VAC
Operating frequency	DC to 60 Hz
Rated currents	35 to 300 A @ 50°C
High potential test voltage	P → E 2750 VDC for 2 sec P → P 2250 VDC for 2 sec
Protection category	IP 20
Overload capability	4x rated current at switch on, 1.5x rated current for 1 minute, once per hour
Temperature range (operation and storage)	-25°C to +100°C (25/100/21)
Flammability corresponding to	UL 94 V-2 or better
Design corresponding to	UL 1283, CSA 22.2 No. 8 1986, IEC/EN 60939
MTBF @ 50°C/400 V (Mil-HB-217F)	>400,000 hours



Typical Applications

- Conventional motor drives with long motor cables and high interference levels
- Four quadrant motor drives and servo drives with energy regeneration mode (in combination with a suitable line reactor or LCL filter)
- Industrial applications comprising power conversion devices, such as machinery, machine tools and process automation equipment
- Uninterruptible power supplies (UPS)
- Converters for renewable energy generation
- Thyristor drives
- Elevators and cranes

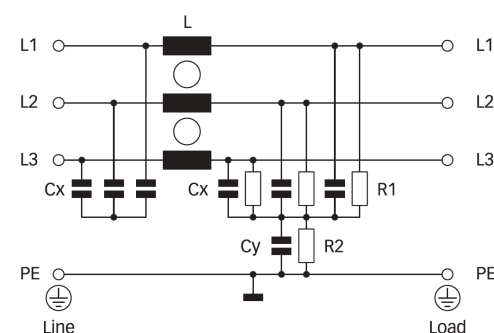
Typical electrical schematic



Filter Selection Table

Filter	Rated current @ 50°C (40°C)	Typical drive power rating*	Leakage current** @ 520 VAC/50 Hz	Power loss @ 25°C/50 Hz	Input/Output connections		Weight
	[A]	[kW]	[mA]	[W]			[kg]
FN 3100-35-33	35 (38.4)	22	6.8	11.8	-33		2.3
FN 3100-50-34	50 (54.8)	30	9.3	18.0	-34		3.4
FN 3100-80-35	80 (87.6)	45	10.0	25.9	-35		5.0
FN 3100-110-35	110 (120.5)	55	10.0	32.7	-35		5.4
FN 3100-150-40	150 (164.3)	75	10.0	50.6	-40		8.5
FN 3100-200-40	200 (219)	110	10.0	67.2	-40		9.1
FN 3100-230-40	230 (230)	132	10.0	36.5	-40		9.2
FN 3100-300-99	300 (329)	160	10.0	54.0		-99	11.8

* Calculated at rated current, 480 VAC and cos phi=0.8. The exact value depends upon the efficiency of the drive, the motor and the entire application.

** Standardized calculated leakage current acc. IEC60939 under normal operating conditions.

Typical Filter Attenuation

Per CISPR 17; A=50 Ω/50 Ω sym; B=50 Ω/50 Ω asym; C=0.1 Ω/100 Ω sym; D=100 Ω/0.1 Ω sym

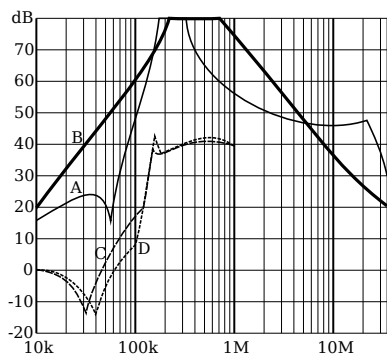

35 to 80 A types

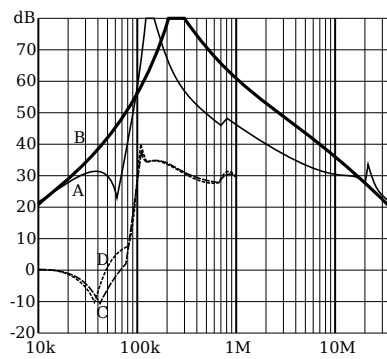

110 and 150 A types

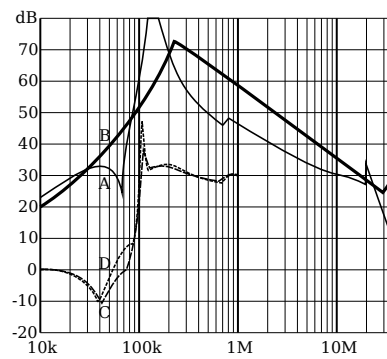

200 A types

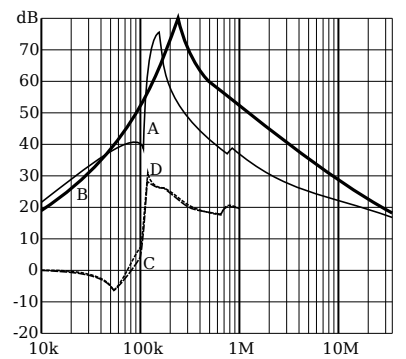

230 and 300 A types

Mechanical Data

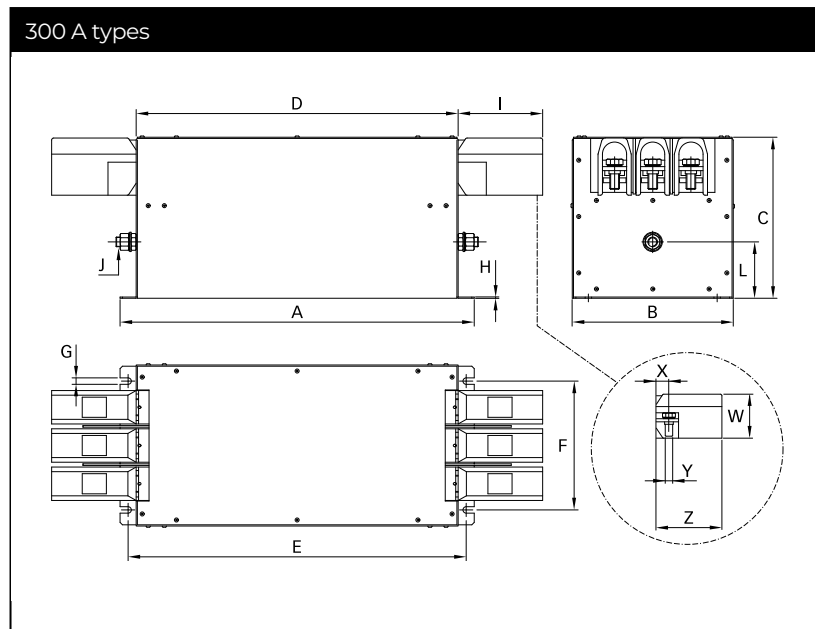
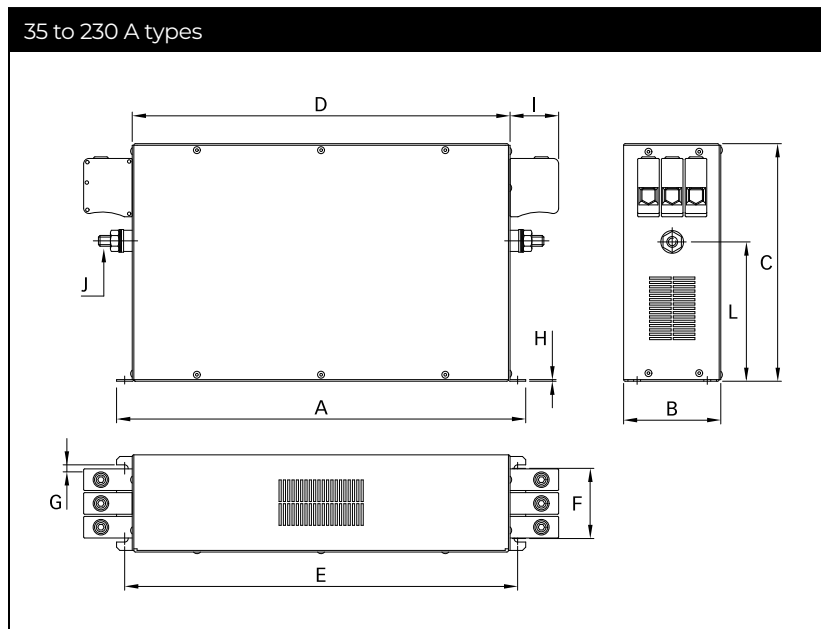

Dimensions

	35 A	50 A	80 A	110 A	150 A	200 A	230 A	300 A
A	335	329	379	379	438	438	438	440
B	60	80	90	90	110	110	110	200
C	150	185	220	220	240	240	240	200
D	305	300	350	350	400	400	400	400
E	320	314	364	364	413	413	413	420
F	35	55	65	65	80	80	80	160
G	6.5	6.5	6.5	6.5	6.5	6.5	6.5	8
H	1	1.5	1.5	1.5	4	4	4	1.5
I	25	39	45	45	51	51	51	105
J	M5	M6	M10	M10	M10	M10	M10	M12
L	93.5	107	129	129	108	108	108	70
W								71.5
X								~22
Y								M12
Y								~105

All dimensions in mm; 1 inch = 25.4 mm
Tolerances according: ISO 2768-m/EN 22768-m

Filter Input/Output Connector Cross Sections

	-33	-34	-35	-40	-99
Solid wire	16 mm ²	35 mm ²	50 mm ²	95 mm ²	-
Flex wire	10 mm ²	25 mm ²	50 mm ²	95 mm ²	150 mm ²
AWG type wire	AWG 6	AWG 2	AWG 1/0	AWG 4/0	AWG 6/0
Recommended torque	1.5 - 1.8 Nm	4.0 - 4.5 Nm	7 - 8 Nm	17 - 20 Nm	27 - 30 Nm

Please visit www.schaffner.com to find more details on filter connectors.

Headquarters, Global Innovation and Development

Switzerland

Schaffner Holding AG

Industrie Nord
 Nordstrasse 11e
 4542
 Luterbach
 +41 32 681 66 26
info@schaffner.com

Sales and Application Centers

China

Schaffner EMC Ltd. Shanghai

T20-3 C, No 565 Chuangye Road, Pudong district
 201201
 Shanghai
 +86 2138139500
cschina@schaffner.com

Finland

Schaffner Oy

Sauvonrinne 19 H
 8500
 Lohja
 +358 50 468 7284
finlandsales@schaffner.com

France

Schaffner EMC S.A.S.

16-20 Rue Louis Rameau
 95875
 Bezons
 +33 1 34 34 30 60
francesales@schaffner.com

Germany

Schaffner Deutschland GmbH

Schoemperlenstrasse 12B
 76185
 Karlsruhe
 +49 721 56910
germanysales@schaffner.com

India

Schaffner India Pvt. Ltd

Regus World Trade Centre
 WTC, 22nd Floor Unit No 2238, Brigade Gateway Campus, 26/1, Dr. Rajkumar Road Malleshwaram (W)
 560055
 Bangalore
 +91 8067935355
indiasales@schaffner.com

Italy

Schaffner EMC S.r.l.

Via Ticino, 30
 20900
 Monza (MB)
 +39 039 21 41 070
italysales@schaffner.com

Japan

Schaffner EMC K.K.

ISM Sangenjaya 7F
 1-32-12 Kamiuma, Setagaya-ku
 154-0011
 Tokyo
 +81 3 5712 3650
japansales@schaffner.com

Singapore

Schaffner EMC Pte Ltd.

Blk 3015A Ubi Road 1, #05-09, Kampong Ubi Industrial Estate
 408705
 Singapore
 +65 63773283
singaporesales@schaffner.com

Spain

Schaffner EMC España

Calle Caléndula 93, Miniparc III, Edificio E El Soto de Moraleja, Alcobendas
 28109
 Madrid
 +34 917 912 900
spainsales@schaffner.com

Sweden

Schaffner EMC AB

Östermalmstrorg 1
 114 42
 Stockholm
 +46 8 5050 2425
swedensales@schaffner.com

Switzerland

Schaffner EMV AG

Industrie Nord
 Nordstrasse 11e
 4542
 Luterbach
 +41 32 681 66 26
switzerlandsales@schaffner.com

Taiwan

Schaffner EMV Ltd.

U-Town
 20 Floor-2, No 97, Section 1, XinTai 5th Road, XiZhi District
 22175
 New Taipei City
 +886 226975500
taiwansales@schaffner.com

Thailand

Schaffner EMC Co. Ltd.

Sathorn Square Tower
 Room 3780, 37FL, 98 North-Sathorn Rd, Silom, Bangrak
 10500
 Bangkok
 +66 621056397
thailandsales@schaffner.com

United Kingdom

Schaffner Ltd.

1, Oakmede Place
 Terrace Road
 RG42 4JF
 Binfield
 +44 118 9770070
uksales@schaffner.com

United States

Schaffner EMC Inc.

52 Mayfield Avenue
 Edison, New Jersey
 +1 732 225 9533
usasales@schaffner.com

To find your local partner within Schaffner's global network schaffner.com

© 2022 Schaffner Group

The content of this document has been carefully checked and understood. However, neither Schaffner nor its subsidiaries assume any liability whatsoever for any errors or inaccuracies of this document and the consequences thereof. Published specifications are subject to change without notice. Product suitability for any area of application must ultimately be determined by the customer. In all cases, products must never be operated outside their published specifications. Schaffner does not guarantee the availability of all published products. This disclaimer shall be governed by substantive Swiss law and resulting disputes shall be settled by the courts at the place of business of Schaffner Holding AG. Latest publications and a complete disclaimer can be downloaded from the Schaffner website. All trademarks recognized.